

DATA SHEET

SUNGMUN CODE : KHS-82C
DESCRIPTION : DIP SWITCH

SUNGMUN ELECTRONICS CO., LTD.

Address 301-302,Bucheon Technopark 345, Seokcheon-ro, Ojeong-gu
Bucheon-si, Gyeonggi-do, Korea
TEL. +82-32-328-1941~4
FAX +82-32-328-1945
E-mail sungmun@sungmun.co.kr
Website www.sungmun.com

MRK	DATE	REVISION	SIGN
-----	------	----------	------

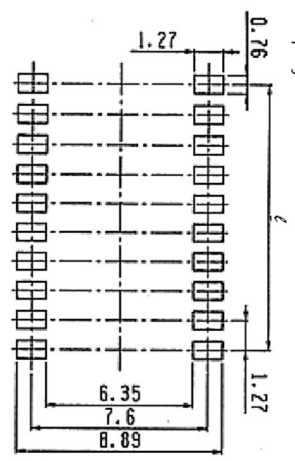
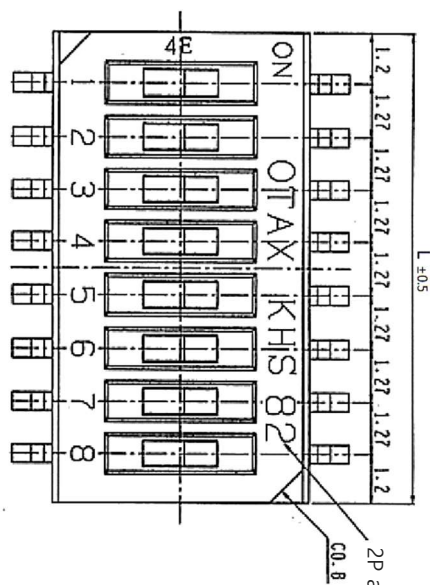

PCB DIMENSION

SPECIFICATION

1. RATING : DC 24V 25mA (Switching)
DC 50V 100mA (Non-Switching)
2. CONTACT RESISTANCE : 100mΩ MAX. (DC 2V 10mA)
3. INSULATION RESISTANCE : DC 100V 100MΩ MIN.
4. WITHSTAND VOLTAGE : 300V AC 1 minute.
5. LIFE CYCLE : 1,000 CYCLES
6. OPERAING FORCE : 4.9N MAX.

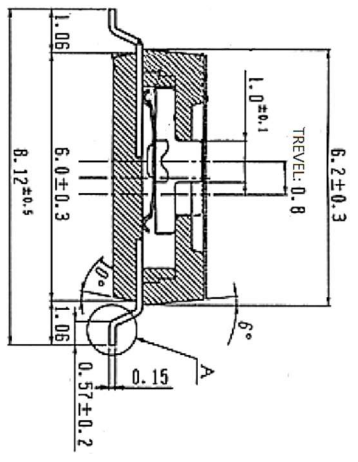
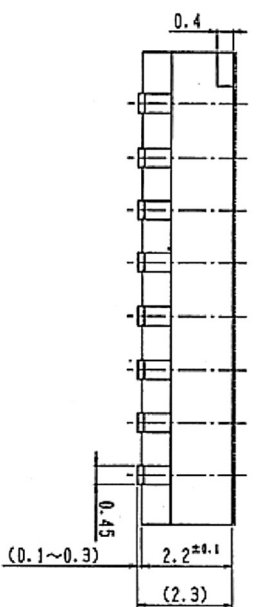

MODEL	POLE	L (mm)	ℓ (mm)
KHS-22C	2	3.67	1.27
KHS-42C	4	6.21	3.81
KHS-62C	6	8.75	6.35
KHS-82C	8	11.29	8.89
KHS-102C	10	13.83	11.43

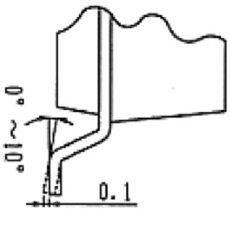

PART A

01	-	DESCRIPTION	MATERIAL		-	1	-
DRAW/DESIGNED	CHECKED	APPROVED	UNIT	SCALE	TITLE	Q.TY	VENDOR
W.JLEE	J.P.ROH	K.I.LEE	mm	4:1	DIP SWITCH		
SUNGJUN ELECTRONICS CO.,LTD			SIZE	MODEL	KHS-XX2C		
			A4	DRAW NO.	KHS-002C-0T-01		
							SHEET
							1/1

1. Description:

This specification describes "DIP SWITCHES", mainly used as signal switch of electric devices, with the general requirements of mechanical and electrical characteristics.

1-1 Operating / Storage Temperature Range : -30°C ~ +80°C

2. Rating:

2-1 Non-Switching : 100mA, DC 50V

2-1 Switching : 25mA, DC 24V

3. Type of Actuation : Actuated by sliding

4. Electrical Characteristics

ITEM	DESCRIPTION	TEST CONDITIONS	REQUIREMENTS
4-1	Visual Examination	By visual examination check without any out pressure & testing.	There shall be no defects that affect the serviceability of the product.
4-2	Contact Resistance	① To be measured between the two terminals associated with each switch pole. ② Measurements shall be made with a 1kHz shall current contact resistance meter.	100mΩ max. (initial)
4-3	Insulation Resistance	100V DC, 1minute ±5seconds	100 MΩ min.
4-4	Dielectric withstanding Voltage	300V AC(50Hz or 60Hz)shall be applied between all the adjacent terminal and between the terminal and the frame for 1 minute.	There shall be no breakdown or flashover.

5. Mechanical Characteristics

ITEM	DESCRIPTION	TEST CONDITIONS	REQUIREMENTS
5-1	Operation Force	Applied in the direction of operation. ON(OFF OFF(ON 	500 gf max.
5-2	Stop Strength	0.8kgf is applied in the operating direction and pulling direction operated for a period of 15 seconds.	There shall be no sign of damage mechanically.
5-3	Soldering Heat Resistance	1. Duration of Solder Immersion: 5±1seconds. 2. Frequency of Solder Process: 1 time max. (PCB is 1.6mm in thickness.)	1)As shown in item 4-3, 4-4, 5-1, 5-2 2)Contact Resistance: 200mΩ max (final-after test)
5-4	Operation Life	Measurements shall be made following the test set forth below: 1) 25mA, 24V DC resistive load 2) Rate of operation: 15~20 cycles/ min 3) Cycle of operation: 1,000 cycles	1)As shown in item 4-3, 4-4, 5-1, 5-2 2)Contact Resistance: 1Ω max (final-after test)

6. Environmental Characteristics

ITEM	DESCRIPTION	TEST CONDITIONS	REQUIREMENTS
6-1	Moisture Resistance	Following the test set forth below the sample shall be left in normal temperature and humidity conditions for one hour before measurements. Are made : 1) Temperature : 40±2°C 2) Relative humidity : 90 to 95% 3)Time: 250 hours Water drops shall be removed.	1)As shown in item 4-4, 5-1, 5-2 2)Contact resistance : 200mΩ Max. 3)Insulation resistance : 10MΩ Min.

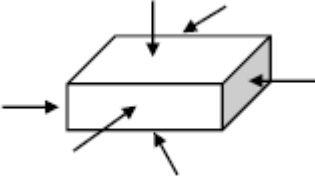
ITEM	DESCRIPTION	TEST CONDITIONS	REQUIREMENTS
6-2	Resistance Low Temperature	<p>Following the test set forth below the sample shall be left in normal temperature and humidity conditions for an hour before measurements are made:</p> <p>1)Temperature: $-45^{\circ}\text{C} \pm 3^{\circ}\text{C}$ 2)Time: 250 hours Water drops shall be removed.</p>	<p>1)As shown in item 4-3, 4-4, 5-1, 5-2</p> <p>2)Contact resistance: 200mΩ Max. (final-after test)</p>
6-3	Resistance High Temperature	<p>Following the test set forth below the sample shall be left in normal temperature and humidity conditions for an hour before measurements are made:</p> <p>1)Temperature: $+100^{\circ}\text{C} \pm 3^{\circ}\text{C}$ 2)Time: 250 hours</p>	<p>1)As shown in item 4-3, 4-4, 5-1, 5-2</p> <p>2)Contact resistance: 200mΩ Max. (final-after test)</p>
6-4	Impact Shock Resistance	<p>Measurements shall be made following the test set forth below :</p> <p>1) Acceleration : 50G 2) Action Time : 11 ± 1 m seconds 3) Testing Direction : 6 sides 4) Test cycle : 3 times in each direction</p> 	<p>As shown in item 4-2, 4-3, 4-4, 5-1, 5-2</p>
6-5	Vibration Resistance	<p>Measurements shall be made following the test set forth below :</p> <p>1) Frequency : 10-55-10 Hz 1min/cycle. 2) Direction : 3 vertical directions including the direction of operation. 3) Test Time : 2 hours each direction.</p>	<p>As shown in item 4-2, 4-3, 4-4, 5-1, 5-2</p>

7. This item is "RoHS" Compliant

8. Soldering Conditions

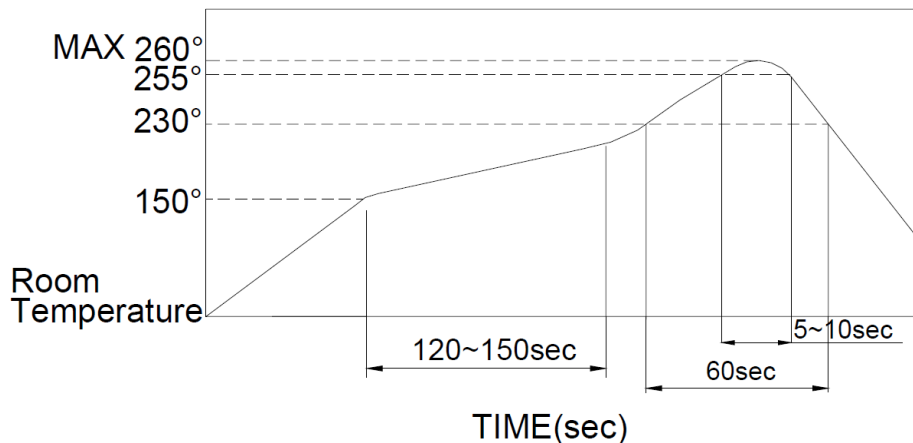

8-1 The condition mentioned above is the temperature on the Cu foil of the P.C.B surface.

There are cases where board's temperature greatly differs from switch's surface temperature depending on board's material, size, thickness, etc.

Care, therefore, should be used not to allow switch's surface temperature to exceed 240°C, 3 sec.

8-2 Manual Soldering : Max 270°C, 3 sec.

8-3 Precautions in Handling :

- 1) Care should be exercised so that flux from the upper part of the printed circuit board does not adhere to the switch.
- 2) Don't clean the switch body except with top tape sealed type, which can only spray of cleaning method from top of s/w.