

Typical Units

Non Isolated, 12V_{IN}, 0.8-5V_{OUT} 28 Amp DC/DC Converters

FEATURES

- Eighth brick, through hole or SMT
- 2-phase buck regulators for new
- distributed 12V power architectures
- 12V input (10.2-13.8V range)
- 0.8-2.5V_{OUT}, 3.3V_{OUT} @ 28A, 5V_{OUT} @ 25A
- Non-isolated, fixed-frequency
- Synchronous-rectifier topology
- Efficiencies to 95% @ 25 Amps
- Noise as low as 25mVp-p
- Stable no-load operation
- On/Off control, trim & sense functions
- Input Over/Undervoltage lockout
- Thermal shutdown
- Designed to meet UL/EN/IEC60950-1
- EMC compliant

PRODUCT OVERVIEW

The LEN D12 Series of non-isolated eighth bricks are ideal building blocks for emerging, on-board power-distribution schemes in which isolated 12V buses deliver power to any number of non-isolated, step-down buck regulators. LEN D12 DC/DCs accept a 12V input (10.2V to 13.8V input range) and convert it, with the highest efficiency in the smallest space, to a 0.8, 1, 1.2, 1.5, 1.8, 2, 2.5, or 3.3 Volt output fully rated at 28 Amps, or 5 Volt output at 25 Amps.

LEN D12s are ideal POLPP's (point-of-use/load power processors) and they typically require no external components. They occupy the standard eighth-brick board space (0.9" x 2.3") and come in either through-hole packages or surface-mount packages with a profile of only 0.46" (0.5" including optional heat sink).

The LEN's best-in-class power density is achieved with a fully synchronous, fixed-frequency, 2-phase buck topology that deliv-

ers extremely high efficiency (95% for 5V_{OUT} models), low noise (25mVp-p typ.), tight line/load regulation ($\pm 0.25\%$ max.), quick step response (150 μ sec), stable no-load operation, and no output reverse conduction.

The fully functional LEN's feature input over/undervoltage lockout, output overvoltage and overcurrent detection, continuous short-circuit protection, overtemperature protection, an output-voltage trim function, a remote on/off control pin, and a sense pin. High efficiency enables the LEN D12s to deliver rated output currents of 25 Amps at ambient temperatures to +65°C with 200 lfm air flow without heat sink.

If your new system boards call for multiple supply voltages, check out the economics of on-board 12V distributed power. If you don't need to pay for multiple isolation barriers, MPS's non-isolated 1/4 and 1/8 brick's will save you money.



For full details go to
www.murata-ps.com/rohs

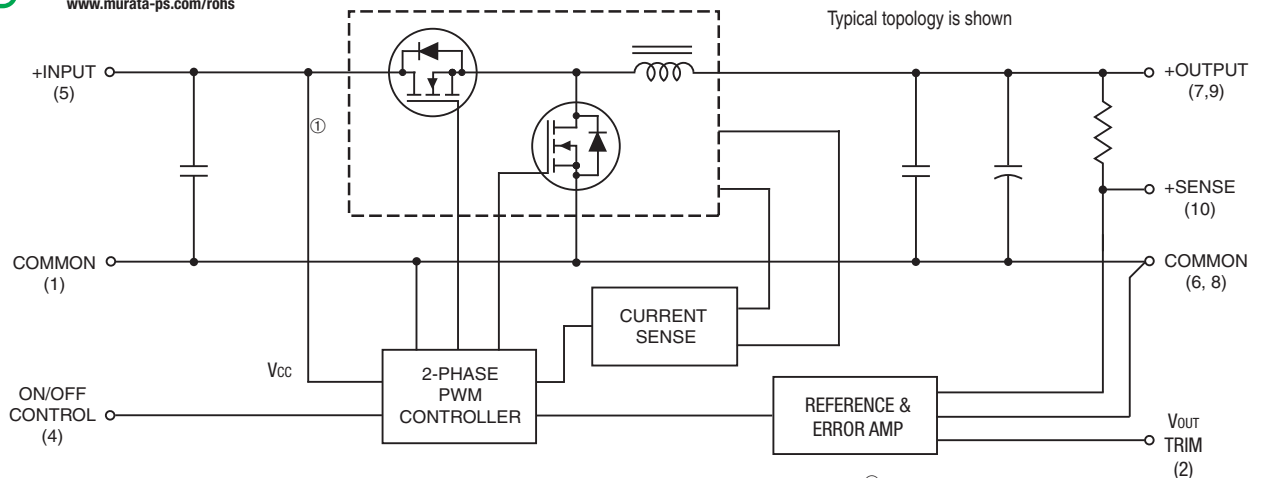

Figure 1. Simplified Schematic

① Only one phase of two shown.

Performance Specifications and Ordering Guide ①

Models	Output						Input			Efficiency			Package (Case, Pinout)
	V _{OUT} (Volts)	I _{OUT} (Amps)	R/N (mVp-p) ②		Regulation (Max.) ③		V _{IN} Nom. (Volts)	Range ⑤ (Volts)	I _{IN} ④ (mA/A)	Full Load		½ Load	
			Typ.	Max.	Line	Load				Min.	Typ.	Typ.	
LEN-0.8/28-D12	0.8	28	30	50	±0.25%	±0.25%	12	10.2-13.8	80/2.3	79%	80%	84.5%	C43,C44, P62
LEN-1/28-D12	1	28	30	50	±0.25%	±0.25%	12	10.2-13.8	80/2.8	80%	82.5%	86%	C43,C44, P62
LEN-1.2/28-D12	1.2	28	30	50	±0.25%	±0.25%	12	10.2-13.8	83/3.3	83%	86.5%	88%	C43,C44, P62
LEN-1.5/28-D12	1.5	28	20	50	±0.25%	±0.25%	12	10.2-13.8	89/4	85%	88%	90%	C43,C44, P62
LEN-1.8/28-D12	1.8	28	20	50	±0.2%	±0.25%	12	10.2-13.8	92/4.7	89%	90%	91%	C43,C44, P62
LEN-2/28-D12	2	28	20	50	±0.25%	±0.25%	12	10.2-13.8	100/5.2	88%	90%	91.5%	C43,C44, P62
LEN-2.5/28-D12	2.5	28	20	50	±0.25%	±0.25%	12	10.2-13.8	130/6.4	89%	91%	93%	C43,C44, P62
LEN-3.3/28-D12	3.3	28	30	50	±0.25%	±0.25%	12	10.2-13.8	130/7.4	91%	93%	94%	C43,C44, P62
LEN-5/25-D12	5	25	30	50	±0.25%	±0.25%	12	10.2-13.8	130/11	92%	95%	95.5%	C43,C44, P62

- ① Typical at T_A = +25°C under nominal line voltage and full-load conditions, unless otherwise noted. All models are tested and specified with external 33µF capacitor installed across their input and output pins.
- ② Ripple/Noise (R/N) is tested/specified over a 20MHz bandwidth.
- ③ These devices have no minimum-load requirements and will regulate under no-load conditions. Regulation specifications describe the output-voltage deviation as the line voltage or load is varied from its nominal/midpoint value to either extreme.

- ④ Nominal line voltage, no-load/full-load conditions.
- ⑤ The operating input voltage is 10.2V to 13.8V. However, 10.8V_{IN} is required for the DC/DC to properly start up under all line, load and temperature conditions. The 10.8V potential must be maintained across the inputs until the output is up and regulating. After the output is regulating, the operating input range is 10.2V to 13.8V.
- ⑥ There are incomplete model numbers. Please refer to the Part Number Structure when ordering.

PART NUMBER STRUCTURE

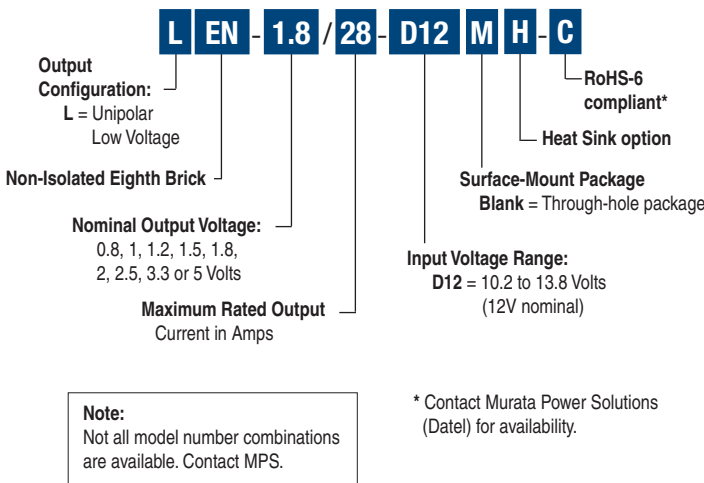

MECHANICAL SPECIFICATIONS

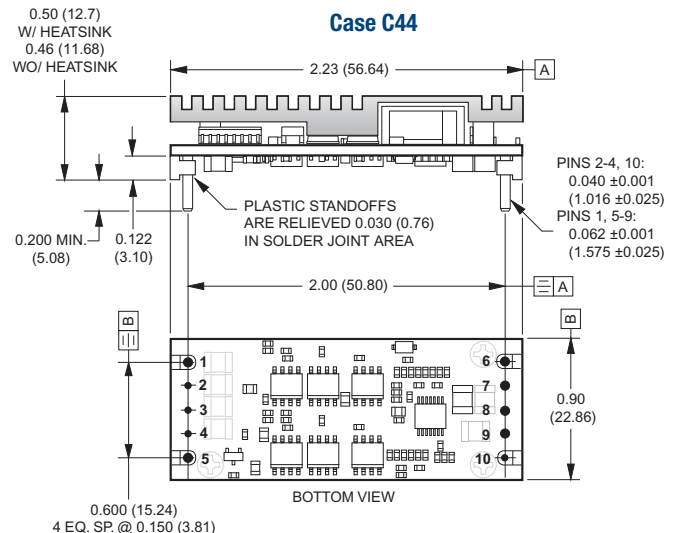
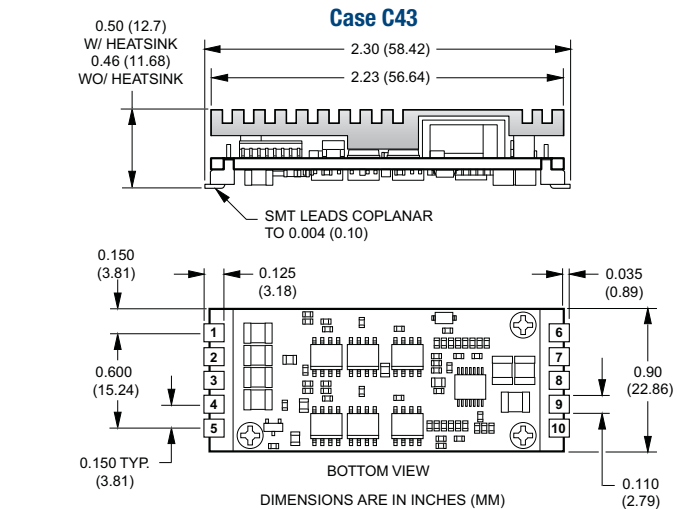

I/O Connections			
Pin	Function P62	Pin	Function P62
1	Common	6	Common
2	V _{OUT} Trim	7	+Output
3	NC	8	Common
4	On/Off control	9	+Output
5	+Input	10	+Sense

Component locations are typical and may vary with different models.

Performance/Functional Specifications

Typical @ T_A = +25°C under nominal line voltage and full-load conditions unless noted. ①

Input	
Input Voltage Range	10.2-13.8 Volts (12V nominal) ⑥
Input Current:	
Normal Operating Conditions	See Ordering Guide
Inrush Transient	TBD
Standby/Off Mode	3.5mA
Output Short-Circuit Condition ②	130mA
Input Reflected Ripple Current ②	20mA _{p-p}
Input Filter Type	Capacitive (66µF)
Overvoltage Protection	14.3 Volts
Reverse-Polarity Protection	None
Undervoltage Shutdown	9.4 Volts
On/Off Control ③	On = open or 0 to +0.4V Off = +2.8V to +V _{IN} (<3mA)
Output	
V_{out} Accuracy (50% load)	±1.5% maximum
Minimum Loading ①	No load
Maximum Capacitive Load	10,000µF (low ESR, OSCON)
V_{out} Trim Range ②	±10% for V _{OUT} = ≥1.8V +10%/-3% for V _{OUT} 1.5V and lower (no trim for 0.8V models)
Ripple/Noise (20MHz BW) ① ② ④	See Ordering Guide
Total Accuracy	3% over line/load temperature
Efficiency ②	See Ordering Guide
Overcurrent Detection and Short-Circuit Protection: ②	
Current-Limiting Detection Point	35 Amps
Short-Circuit Detection Point	98% of V _{OUT} set
SC Protection Technique	Hiccup with auto recovery
Short-Circuit Current	TBD
Dynamic Characteristics	
Transient Response (25% load step)	100µsec to ±2% of final value
Start-Up Time: ②	
V _{IN} to V _{OUT} and On/Off to V _{OUT}	20ms
Switching Frequency	320kHz ±40kHz
Environmental	
Calculated MTBF ⑤	TBD million hours
Operating Temperature: (Ambient) ②	
Without Derating (With 200 lfm)	-40 to +65°C (model dependent)
With Derating	See Derating Curves
Thermal Shutdown	+125°C
Physical	
Dimensions	See Mechanical Dimensions
Pin Material	Gold-plated copper alloy with nickel underplate
Weight	0.6 ounces (17g)
Flamability Rating	UL94V-0

- ① All models are tested and specified with external 33µF tantalum input and output capacitors. These capacitors are necessary to accommodate our test equipment and may not be required to achieve specified performance in your applications. All models are stable and regulate within spec under no-load conditions.
- ② Input Ripple Current is tested/specified over a 5-20MHz bandwidth with an external 33µF input capacitor and a simulated source impedance of 220µF and 12µH. See I/O Filtering, Input Ripple Current and Output Noise for details.
- ③ The On/Off Control (pin 4) is designed to be driven with open-collector logic or the application of appropriate voltages (referenced to Common, pins 1, 6 and 8).
- ④ Output noise may be further reduced with the installation of additional external output filtering. See I/O Filtering and Noise Reduction.
- ⑤ MTBF's are calculated using Telcordia SR-332(Bellcore), ground fixed, T_A = +25°C, full power, natural convection, TBD pcb temperature.
- ⑥ See Performance Specifications, note 6.

Absolute Maximum Ratings

Input Voltage:	Continuous or transient	15.5 Volts
On/Off Control (Pin 11)		+V _{IN}
Input Reverse-Polarity Protection		None
Output Overvoltage Protection		V _{OUT} +20%
Output Current		Current limited. Devices can withstand sustained output short circuits without damage.
Storage Temperature		-55 to +125°C
Lead Temperature (soldering, 10 sec.)		+300°C

These are stress ratings. Exposure of devices to any of these conditions may adversely affect long-term reliability. Proper operation under conditions other than those listed in the Performance/Functional Specifications Table is not implied.

TECHNICAL NOTES

Return Current Paths

The LEN D12 are non-isolated DC/DC converters. Their Common pins (pins 1, 6 and 8) are connected to each other internally (see Figure 1). To the extent possible (with the intent of minimizing ground loops), input return current should be directed through pin 1 (also referred to as -Input or Input Return), and output return current should be directed through pin 6 and 8 (also referred to as -Output or Output Return). Any on/off control signals applied to pin 4 (On/Off Control) should be referenced to Common (specifically pin 1).

I/O Filtering and Noise Reduction

All models in the LEN D12 Series are tested and specified with external 33µF tantalum input and output capacitors. These capacitors are necessary to accommodate our test equipment and may not be required to achieve desired performance in your application. The LEN D12s are designed with high-quality, high-performance internal I/O caps, and will operate within spec in most applications with *no additional external components*.

In particular, the LEN D12's input capacitors are specified for low ESR and are fully rated to handle the units' input ripple currents. Similarly, the internal output capacitors are specified for low ESR and full-range frequency response. As shown in the Performance Curves, removal of the external 33µF tantalum output caps has minimal effect on output noise.

In critical applications, input/output ripple/noise may be further reduced using filtering techniques, the simplest being the installation of external I/O caps.

External input capacitors serve primarily as energy-storage devices. They minimize high-frequency variations in input voltage (usually caused by IR drops in conductors leading to the DC/DC) as the switching converter draws pulses of current. Input capacitors should be selected for bulk capacitance (at appropriate frequencies), low ESR, and high rms-ripple-current ratings. The switching nature of modern DC/DCs requires that the dc input voltage source have low ac impedance and the frequencies of interest. Highly inductive source impedances can greatly affect system stability. Your specific system configuration may necessitate additional considerations.

Output ripple/noise (also referred to as periodic and random deviations or PARD) may be reduced below specified limits with the installation of additional external output capacitors. Output capacitors function as true filter elements and should be selected for bulk capacitance, low ESR, and appropriate frequency response. Any scope measurements of PARD should be made directly at the DC/DC output pins with scope probe ground less than 0.5" in length.

All external capacitors should have appropriate voltage ratings and be located as close to the converters as possible. Temperature variations for all relevant parameters should be taken into consideration.

The most effective combination of external I/O capacitors will be a function of your line voltage and source impedance, as well as your particular load and layout conditions. Our Applications Engineers can recommend potential solutions and discuss the possibility of our modifying a given device's internal filtering to meet your specific requirements. Contact our Applications Engineering Group for additional details.

Input Fusing

Most applications and or safety agencies require the installation of fuses at the inputs of power conversion components. LEN D12 Series DC/DC converters are not internally fused. Therefore, input fusing is mandatory for safety reasons, and safety agencies require a time delay fuse with a value no greater than 40 Amps, which should be installed within the ungrounded input path to the converter.

As a rule of thumb however, we recommend to use a normal-blow or slow-blow fuse with a typical value of about twice the maximum input current, calculated at low line with the converters minimum efficiency.

Safety Considerations

LEN D12's are non-isolated DC/DC converters. In general, all DC/DC's must be installed, including considerations for I/O voltages and spacing/separation requirements, in compliance with relevant safety-agency specifications (usually UL/IEC/EN60950-1).

In particular, for a non-isolated converter's output voltage to meet SELV (safety extra low voltage) requirements, its input must be SELV compliant. If the output needs to be ELV (extra low voltage), the input must be ELV.

Start-Up Time

The V_{IN} to V_{OUT} Start-Up Time is the interval between the time at which a ramping input voltage crosses the lower limit of the specified input voltage range (10.2 Volts) and the fully loaded output voltage enters and remains within its specified accuracy band. Actual measured times will vary with input source impedance, external input capacitance, and the slew rate and final value of the input voltage as it appears to the converter.

The On/Off to V_{OUT} Start-Up Time assumes the converter is turned off via the On/Off Control with the nominal input voltage already applied to the converter. The specification defines the interval between the time at which the converter is turned on and the fully loaded output voltage enters and remains within its specified accuracy band. See Typical Performance Curves.

Remote Sense

LEN D12 Series DC/DC converters offer an output sense function on pin 10. The sense function enables point-of-use regulation for overcoming moderate IR drops in conductors and/or cabling. Since these are non-isolated devices whose inputs and outputs usually share the same ground plane, sense is provided only for the +Output.

The remote sense line is part of the feedback control loop regulating the DC/DC converter's output. The sense line carries very little current and consequently requires a minimal cross-sectional-area conductor. As such, it is not a low-impedance point and must be treated with care in layout and cabling. Sense lines should be run adjacent to signals (preferably ground), and in cable and/or discrete-wiring applications, twisted-pair or similar techniques should be used. To prevent high frequency voltage differences between V_{OUT} and Sense, we recommend installation of a 1000pF capacitor close to the converter.

The sense function is capable of compensating for voltage drops between the +Output and +Sense pins that do not exceed 10% of V_{OUT} .

$$[V_{OUT(+)} - \text{Common}] - [Sense(+) - \text{Common}] \leq 10\%V_{OUT}$$

Power derating (output current limiting) is based upon maximum output current and voltage at the converter's output pins. Use of trim and sense functions can cause the output voltage to increase, thereby increasing output power beyond the converter's specified rating. Therefore:

$$(V_{OUT \text{ at pins}}) \times (I_{OUT}) \leq \text{rated output power}$$

The internal 10.5Ω resistor between +Sense and +Output (see Figure 1) serves to protect the sense function by limiting the output current flowing through the sense line if the main output is disconnected. It also prevents output voltage runaway if the sense connection is disconnected.

Note: If devices have the +Sense pin (pin 10) installed (no part-number suffix) and the sense function is not used for remote regulation, +Sense (pin 10) must be tied to +Output (pin 7, 9) at the DC/DC converter pins.

On/Off Control

The On/Off Control pin may be used for remote on/off operation. LEN D12 Series DC/DC converters are designed so that they are enabled when the control pin is left open (or pulled low to 0 to +0.4V) and disabled when the control pin is pulled high (+2.8V to $+V_{IN}$). As shown in Figure 2, all models have an internal 20kΩ pull-down resistor to Common (ground).

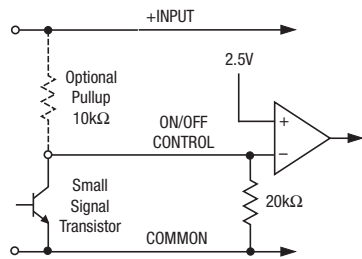

ON/OFF pin open: Logic Low = DC/DC converter On
 ON/OFF pin >2.8V: Logic High = DC/DC converter Off

Figure 2. Driving the On/Off Control Pin

Dynamic control of the on/off function is best accomplished with a mechanical relay or open-collector/open-drain drive circuit (optically isolated if appropriate). The drive circuit should be able to sink appropriate current when activated and withstand appropriate voltage when deactivated.

The on/off control can be driven using a circuit comparable to that shown in Figure 2. Leaving the On/Off control pin open or applying a voltage between 0V and +0.4V will turn on the converter. Applied voltages between +2.8V and +V_{IN} will disable the converter.

Power-up Sequencing

If a controlled start-up of one or more LEN D12 Series DC/DC converters is required, or if several output voltages need to be powered-up in a given sequence, the On/Off control pin can be pulled high to +V_{IN} with an external 5.6kΩ resistor. While input voltage and/or other converters are ramping up, the control pin is pulled high and the converter remains disabled. To enable the output voltage, the control pin needs to be pulled low in the configuration shown in Figure 3.

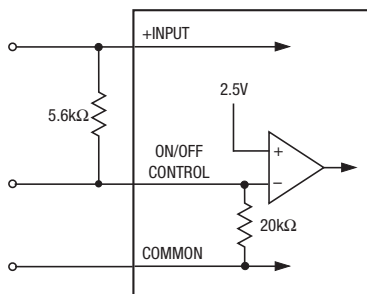

External Input Open: On/Off pin High = DC/DC converter Off
 External Input Low: On/Off pin Low = DC/DC converter On

Figure 3. Driving The Power-Up With An External Pull-up Resistor

Output Overvoltage Protection

The LEN D12 Series output voltage is monitored. If the output voltage rises to a level, which could be damaging to the load, the internal sensing circuitry will power down the PWM controller causing the output voltage to decrease. Following a time-out period the PWM will restart, causing the output voltage to ramp to its appropriate value. If the fault condition persists, and the output voltage again climbs to excessive levels, the overvoltage circuitry will initiate another shutdown cycle. This on/off cycling is referred to as "hiccup" mode.

Output Overcurrent Detection

Overloading the power converter's output for an extended time will invariably cause internal component temperatures to exceed their maximum ratings and eventually lead to component failure. High-current-carrying components such as inductors, FET's and diodes are at the highest risk. LEN D12 Series DC/DC converters incorporate an output overcurrent detection and shutdown function that serves to protect both the power converter and its load.

If the output current exceeds its maximum rating by typically 40% (35 Amps) or if the output voltage drops to less than 98% of its original value, the LEN D12's internal overcurrent-detection circuitry immediately turns off the converter, which then goes into a "hiccup" mode. While hiccupping, the converter will continuously attempt to restart itself, go into overcurrent, and then shut down. Under these conditions, both the average output current and the average input current will be kept extremely low. Once the output short is removed, the converter will automatically restart itself.

Output Voltage Trimming

Allowable trim ranges for models ≥1.8V_{OUT} are ±10%, and for models 1.5V_{OUT} and lower +10%/–3% (no trim for 0.8V models). Trimming is accomplished with either a trimpot or a single fixed resistor. The trimpot should be connected between +Output and Common with its wiper connected to the Trim pin as shown in Figure 4.

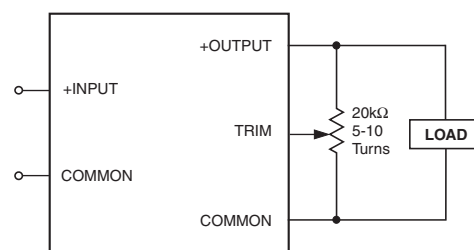
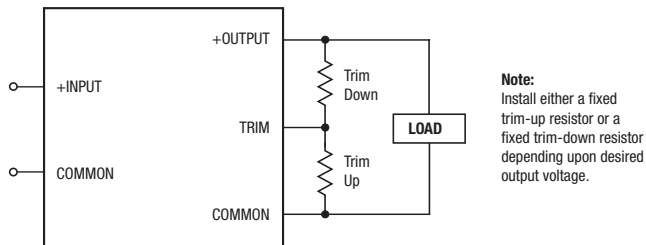

Figure 4. Trim Connections Using a Trimpot

A trimpot can be used to determine the value of a single fixed resistor which can then be connected, as shown in Figure 5, between the Trim pin and +Output to trim down the output voltage, or between the Trim pin and Common to trim up the output voltage. Fixed resistors should have absolute TCR's less than 100ppm/°C to ensure stability.



Note:
Install either a fixed trim-up resistor or a fixed trim-down resistor depending upon desired output voltage.

Figure 5. Trim Connections Using Fixed Resistors

The equations below can be used as starting points for selecting specific trim resistor values. Recall, untrimmed devices are guaranteed to be ±1% accurate.

Adjustment beyond the specified adjustment range is not recommended.

Trim Equations

$$R_{T_DOWN} (k\Omega) = \frac{0.5(V_O - 0.8)}{V_{O_NOM} - V_O} - X \quad R_{T_UP} (k\Omega) = \frac{0.4}{V_O - V_{O_NOM}} - X$$

- LEN-1/28-D12:** X = 0.261
- LEN-1.2/28-D12:** X = 0.750
- LEN-1.5/28-D12:** X = 1.24
- LEN-1.8/28-D12:** X = 1.62
- LEN-2/28-D12:** X = 1.62

LEN-2.5/28-D12

$$R_{T_DOWN} (k\Omega) = \frac{1.18(V_O - 0.8)}{V_{O_NOM} - V_O} - 3.09 \quad R_{T_UP} (k\Omega) = \frac{0.944}{V_O - V_{O_NOM}} - 3.09$$

$$R_{T_DOWN} (k\Omega) = \frac{7.5(V_O - 0.8)}{V_{O_NOM} - V_O} - X \quad R_{T_UP} (k\Omega) = \frac{6}{V_O - V_{O_NOM}} - X$$

- LEN-3.3/28-D12:** X = 14.3
- LEN-5/25-D12:** X = 9.53

Note: LEN-0.8/28-D12 is not trimmable.

Note: Resistor values are in kΩ. Accuracy of adjustment is subject to tolerances of resistors and factory-adjusted, initial output accuracy.

V_O = desired output voltage. V_{O_NOM} = nominal output voltage.

Output Reverse Conduction

Many DC/DCs using synchronous rectification suffer from Output Reverse Conduction. If those devices have a voltage applied across their output before a voltage is applied to their input (this typically occurs when another power supply starts before them in a power-sequenced application), they will either fail to start or self destruct. In both cases, the cause is the “freewheeling” or “catch” FET biasing itself on and effectively becoming a short circuit.

LEN D12 DC/DC converters do not suffer from Output Reverse Conduction. They employ proprietary gate drive circuitry that makes them immune to applied output voltages.

Typical Performance Curves

LEN-0.8/28-D12
Efficiency vs. Line Voltage and Load Current

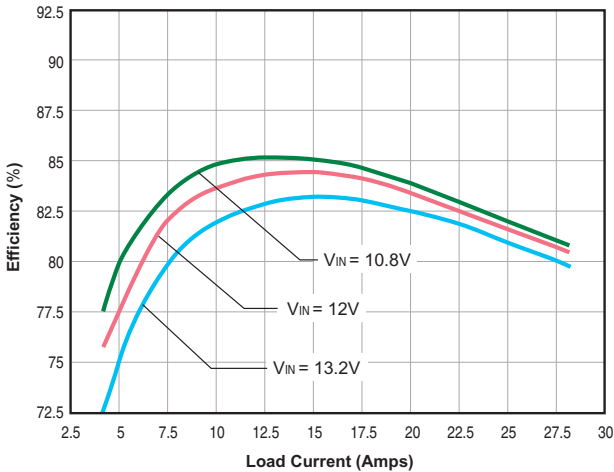

LEN-0.8/28-D12 Maximum Current Temperature Derating
 $V_{IN} = 12V$ (air flow from pin 5 to pin 1)

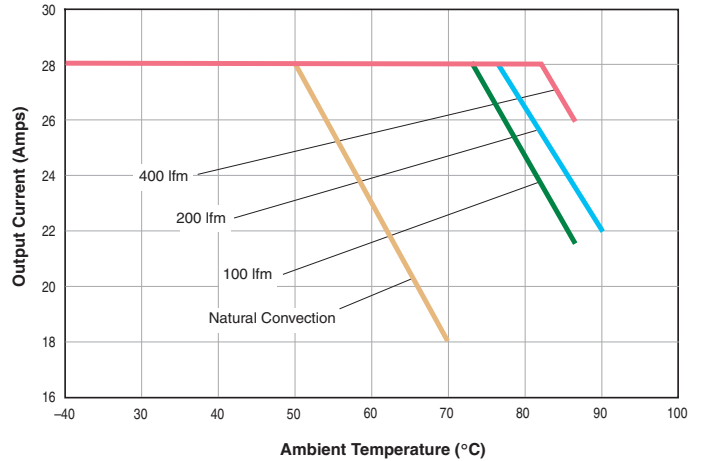

LEN-1/28-D12
Efficiency vs. Line Voltage and Load Current

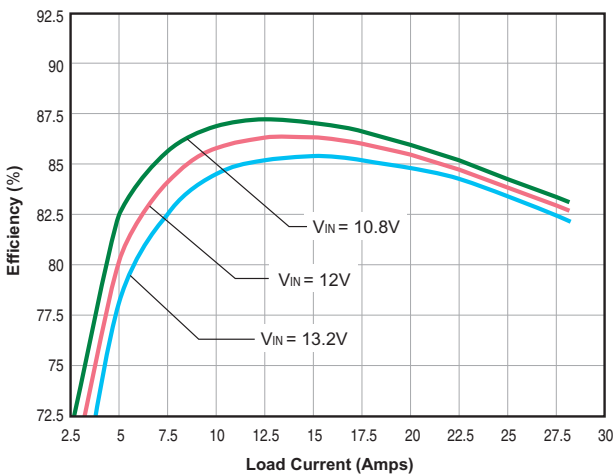

LEN-1/28-D12 Maximum Current Temperature Derating
 $V_{IN} = 12V$ (air flow from pin 5 to pin 1)

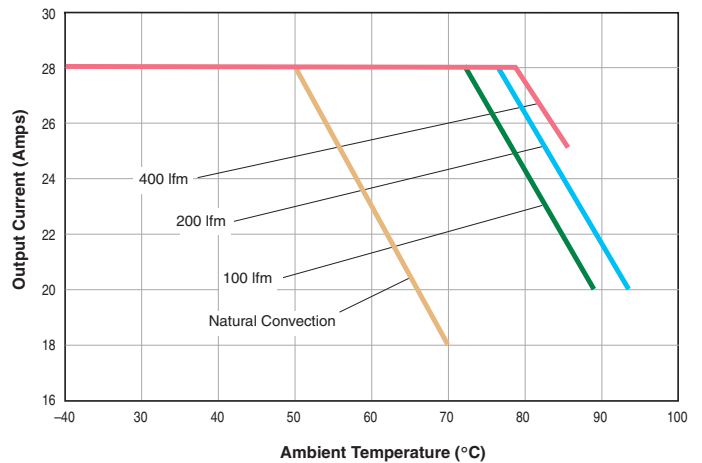

LEN-1.2/28-D12
Efficiency vs. Line Voltage and Load Current

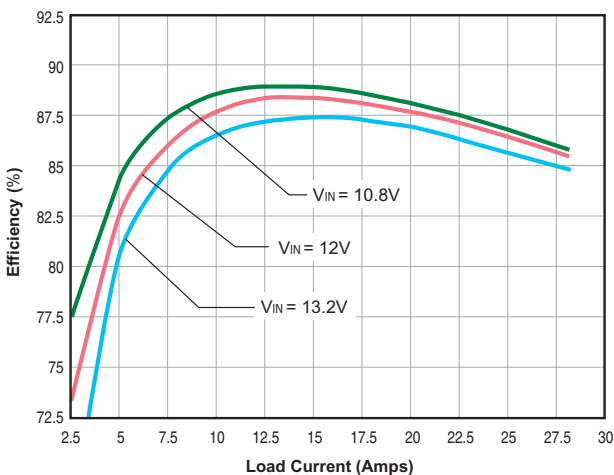

LEN-1.2/28-D12 Maximum Current Temperature Derating
 $V_{IN} = 12V$ (air flow from pin 5 to pin 1)

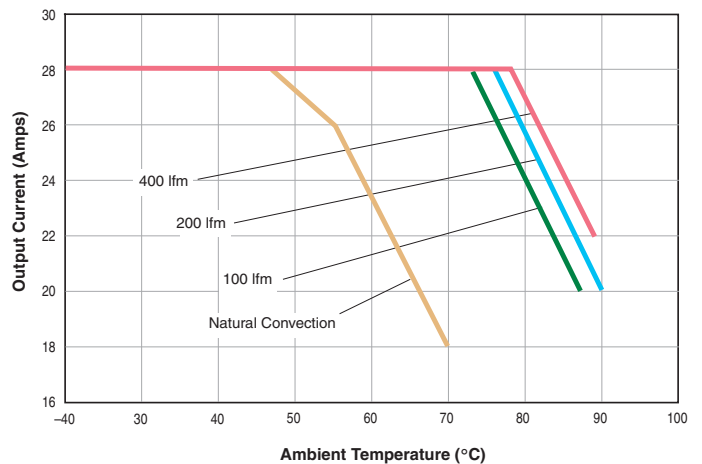

Typical Performance Curves

LEN-1.5/28-D12
Efficiency vs. Line Voltage and Load Current

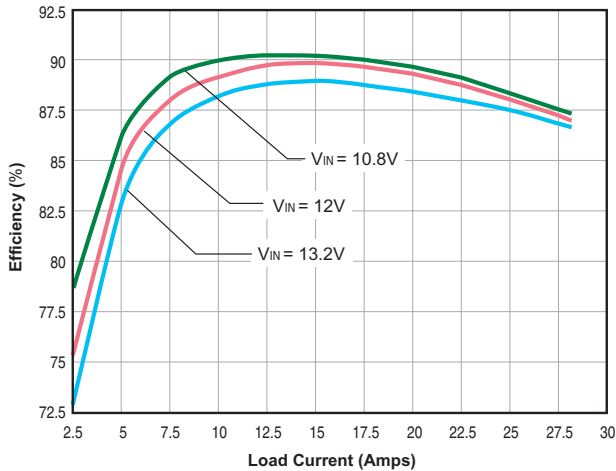

LEN-1.8/28-D12
Efficiency vs. Line Voltage and Load Current

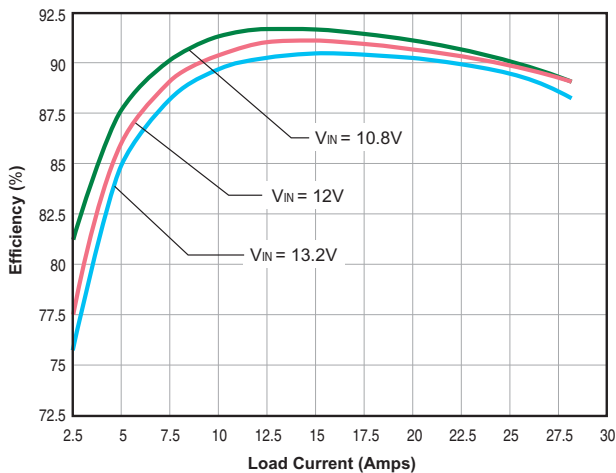

LEN-2/28-D12
Efficiency vs. Line Voltage and Load Current

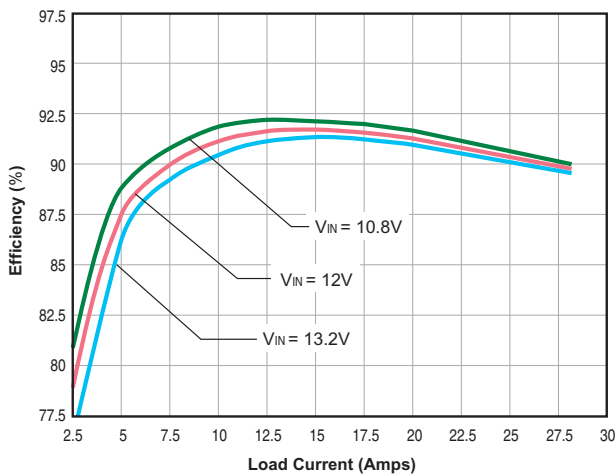

LEN-1.5/28-D12 Maximum Current Temperature Derating
VIN = 12V (air flow from pin 1 to pin 5)

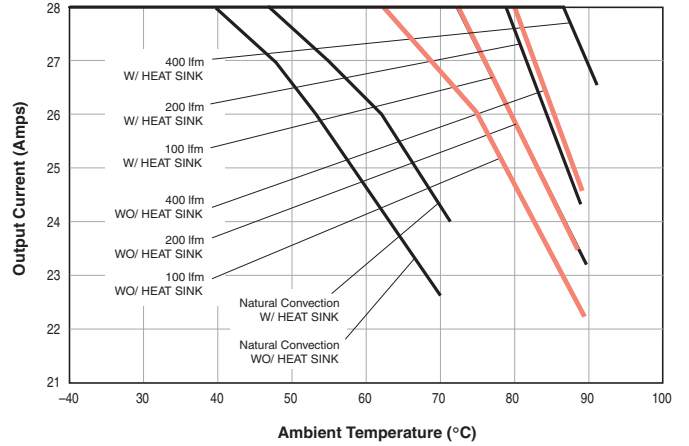

LEN-1.8/28-D12 Maximum Current Temperature Derating
VIN = 12V (without heatsink)

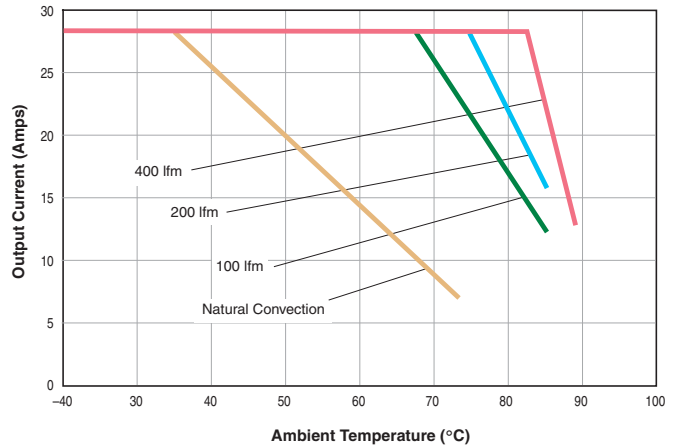

LEN-1.8/28-D12 Maximum Current Temperature Derating
VIN = 12V (with heatsink)

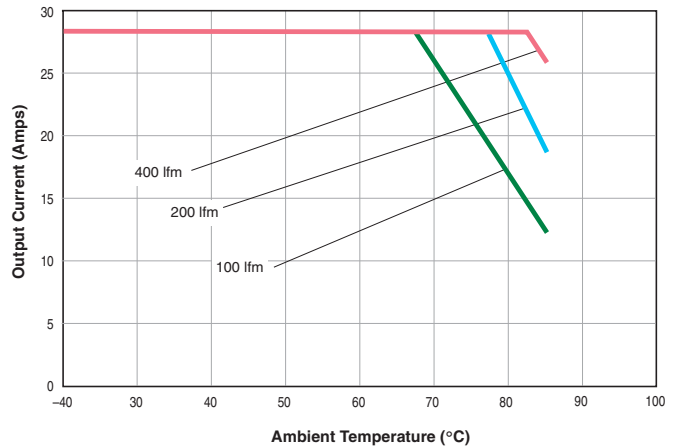

Typical Performance Curves

LEN-2.5/28-D12
Efficiency vs. Line Voltage and Load Current

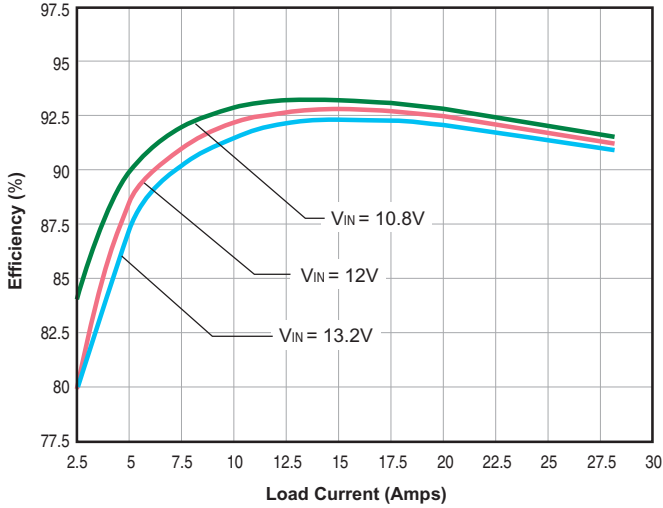

LEN-2.5/28-D12 Maximum Current Temperature Derating
 $V_{IN} = 12V$ (air flow from pin 1 to pin 5)

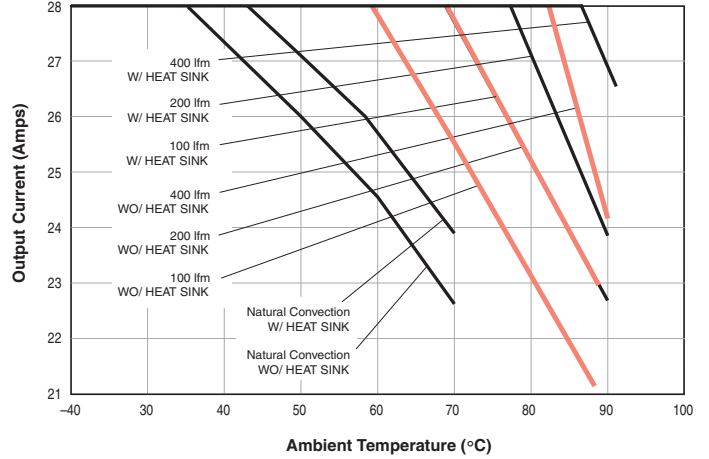

LEN-3.3/28-D12
Efficiency vs. Line Voltage and Load Current

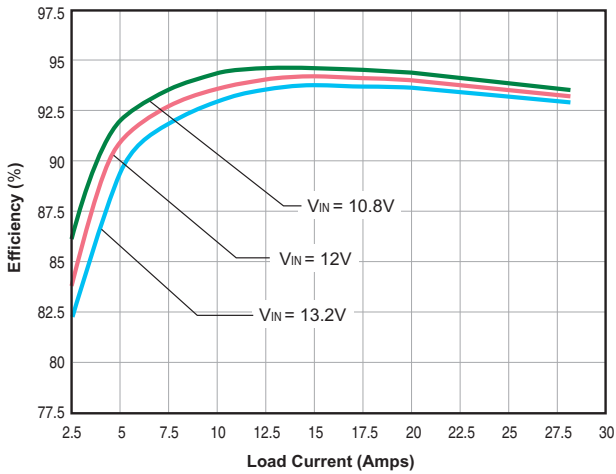

LEN-3.3/28-D12 Maximum Current Temperature Derating
 $V_{IN} = 12V$ (air flow from pin 1 to pin 5)

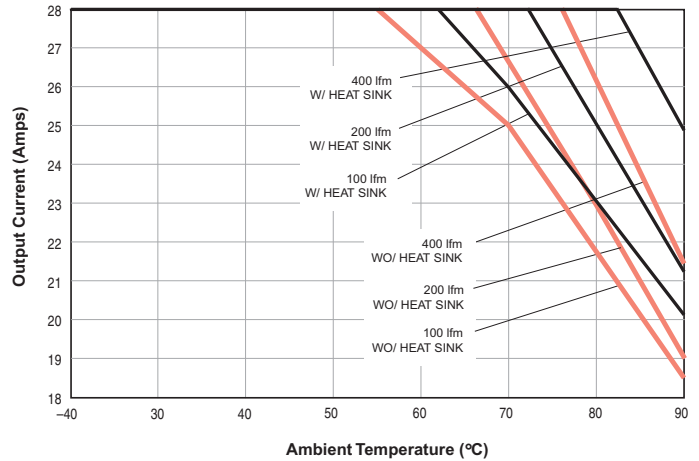

Typical Performance Curves

