



Wall Industries, Inc.

PS800 Series
800 Watt Single Output
PFC and Current Sharing
AC/DC Switching Power Supply

FEATURES

- Remote Sense
- Power Failure Signal
- Remote ON/OFF Control
- 0.98 Typical Power Factor
- Programmable Output Voltage
- Forced Current Sharing at Parallel Operation
- Input Voltage: 90~260VAC (**90 ~ 170VAC Reduced Power**)
- Short Circuit/ Overload/ Over Voltage/ Over Temperature Protection



SPECIFICATIONS: PS800 Series	
All specifications are based on 25°C, Nominal Input Voltage, and Maximum Output Current unless otherwise noted. We reserve the right to change specifications based on technological advances.	
INPUT SPECIFICATIONS	
Input Voltage Range	90 ~ 260VAC **90 ~ 170 VAC reduced power - see "Output Power vs Input Voltage" derating curve**
Input Frequency	47 to 63Hz
Input Current	4.5A at 230VAC (Typical)
Inrush Current	RESULT A: 42.0A (Typical)
Leakage Current	< 3.5mA at 240VAC
Remote ON/OFF Control	Compatible with a TTL signal to turn ON/OFF
OUTPUT SPECIFICATIONS	
Output Voltage	See Table
Output Power Range	800 Watts max.
Output Voltage Adjustability	Maximum - minimum > 15% Adjustment (Typical adjustment by potentiometer) 25% ~ 100% Adjustment by 1 ~ 5VDC external control.
Line Regulation	Less than 1%
Load Regulation	Less than 1%
Output Current	See Table
Ripple & Noise (peak to peak)	1%
Setup, Rise, Hold-Up Time	RESULT A: 12.4ms
Temperature Coefficient	±0.04% / °C (0 ~ 50°C)
Remote Sense	Yes
PROTECTION	
Over Voltage Protection	110% ~ 135% (variable "OVP" follows the adjustable DC output voltage)
Over Load Protection	Current limiting 3 times (1.5", 3.0", 5.0") then intelligent auto recovery before shutdown.
GENERAL SPECIFICATIONS	
Efficiency	See Table
Power Factor	0.98 (Typical)
Power Failure Signal	Open Collector of NPN Transistor
Parallel Operation	Yes
ENVIRONMENTAL SPECIFICATIONS	
Working Temperature	0°C to +50°C @ 100% Load, +65°C @ 50% Load.
Storage Temperature	-20°C to +85°C
Working Humidity	20% to 90% RH
Storage Humidity	10% to 95% RH
Vibration	10 ~ 200Hz, 2g 10 min./1cycle, Period of 60 min. for each axes.
Cooling	Power rating and temperature controlled fan.
PHYSICAL SPECIFICATIONS	
Weight	2.3kg
Dimensions	290(L) x 120(W) x 67.5(H) mm
SAFETY & EMC	
Safety Standards	UL1950, TUV EN60950
EMC Standards	EN55022, EN610000-4-2,3,4,5,6,8,11, EN61000-3-2,3, ENV50204



Wall Industries, Inc.

PS800 Series
800 Watt Single Output
PFC and Current Sharing
AC/DC Switching Power Supply

OUTPUT VOLTAGE / CURRENT RATING CHART

Model Number	Output Voltage	Output Current	Maximum Output Power	Ripple & Noise	Efficiency
PS800S-P009	9 VDC	88.8A	800W	1%	83%
PS800S-P012	12 VDC	66.6A	800W	1%	84%
PS800S-P015	15 VDC	53.3A	800W	1%	85%
PS800S-P018	18 VDC	44.4A	800W	1%	85%
PS800S-P024	24 VDC	33.3A	800W	1%	88%
PS800S-P036	36 VDC	22.2A	800W	1%	88%
PS800S-P048	48 VDC	16.6A	800W	1%	89%
PS800S-P060	60 VDC	13.3A	800W	1%	90%

NOTES

1. Input voltage is 90 ~ 260VAC however, the unit does not reach full power until >170VAC. See derating curve below.
2. Dimensions of the mechanical drawing are shown in millimeters and inches.
3. Weight of the unit is 2300 grams.

DERATING CURVES

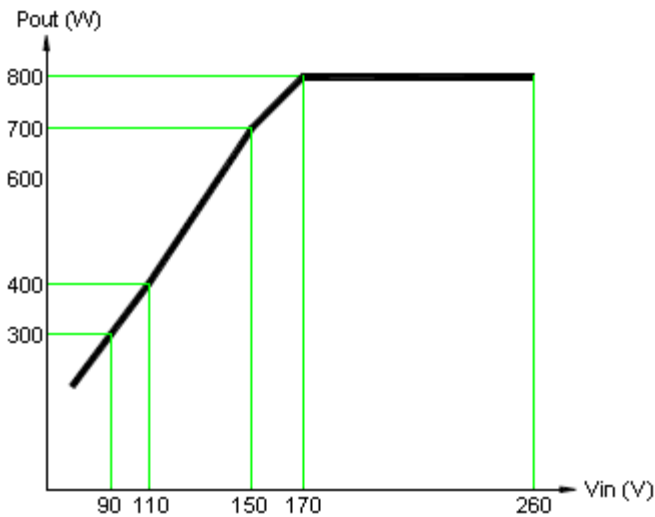

Output Power vs Input Voltage Derating Curve

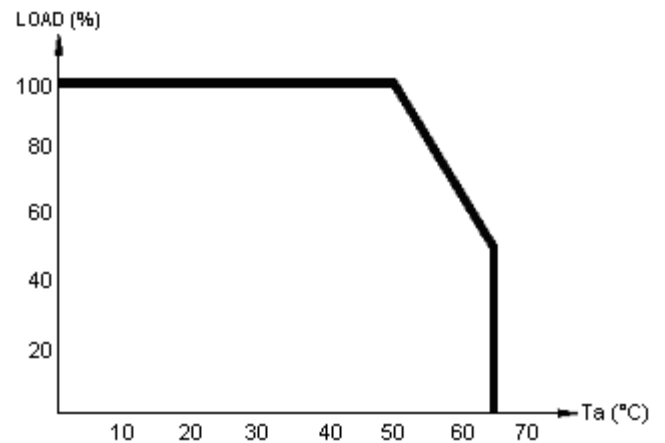

Output Power vs Ambient Temperature Derating Curve

CONNECTOR PIN-OUT DRAWINGS

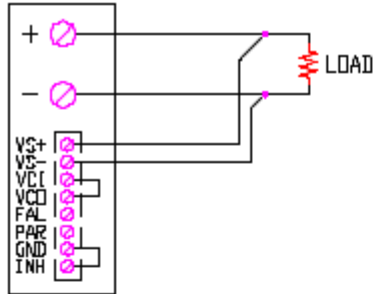

REMOTE SENSING

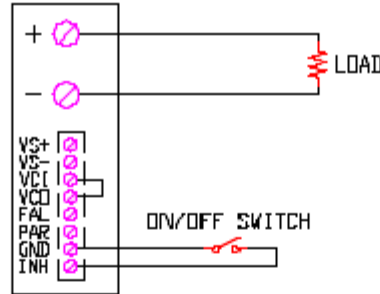

ON/OFF CONTROL BY SWITCH

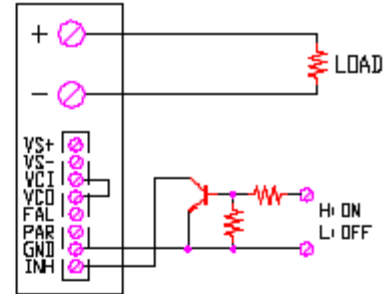

ON/OFF CONTROL BY TRANSISTOR

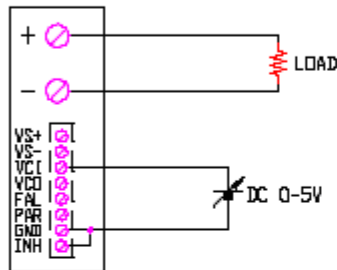

OUTPUT VOLTAGE ADJUST WITH DC 0-5V

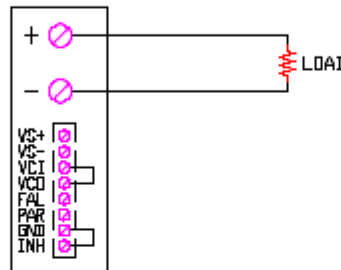

USING INTERNAL VOLTAGE CONTROL

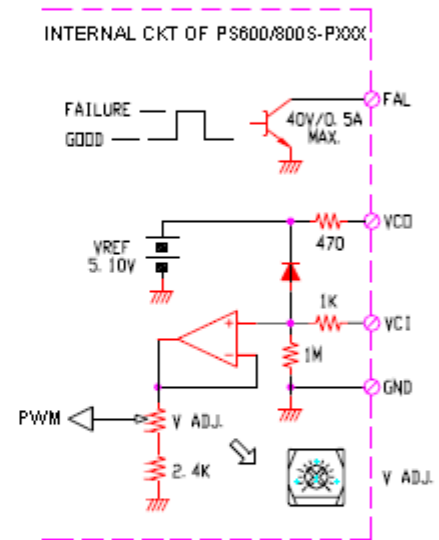

VCI AND VCO SIGNAL

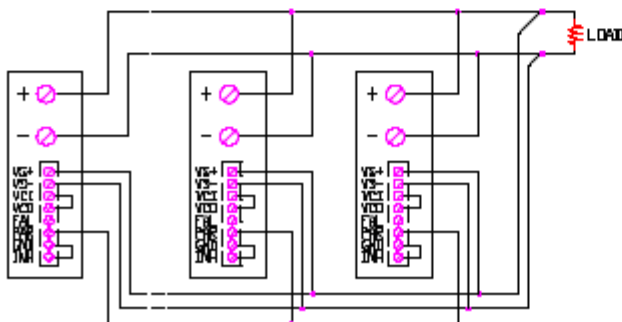

PARALLEL OPERATION WITH REMOTE SENSING

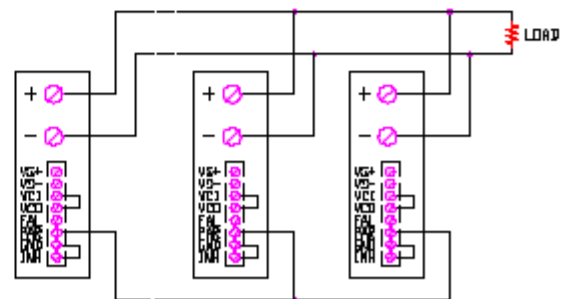

PARALLEL OPERATION WITHOUT REMOTE SENSING



Wall Industries, Inc.

PS800 Series
800 Watt Single Output
PFC and Current Sharing
AC/DC Switching Power Supply

MECHANICAL DRAWING

