

# PRODUCT SPECIFICATION

*Part Number*  
**PDM58140x-W01**

## Details

- 1.4 inch (35.9mm) Dot Matrix Display
- 5x8 Array
- Available in Common Anode or Cathode
- Emitting Color: White

## Features

- Low power consumption
- RoHS Compliant
- Gray or Black Face, White Segment
- Easy mounting on PCB or socket

## Mechanical Dimensions

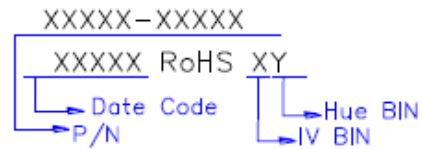
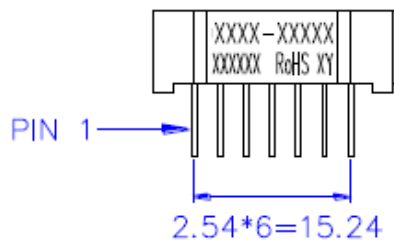
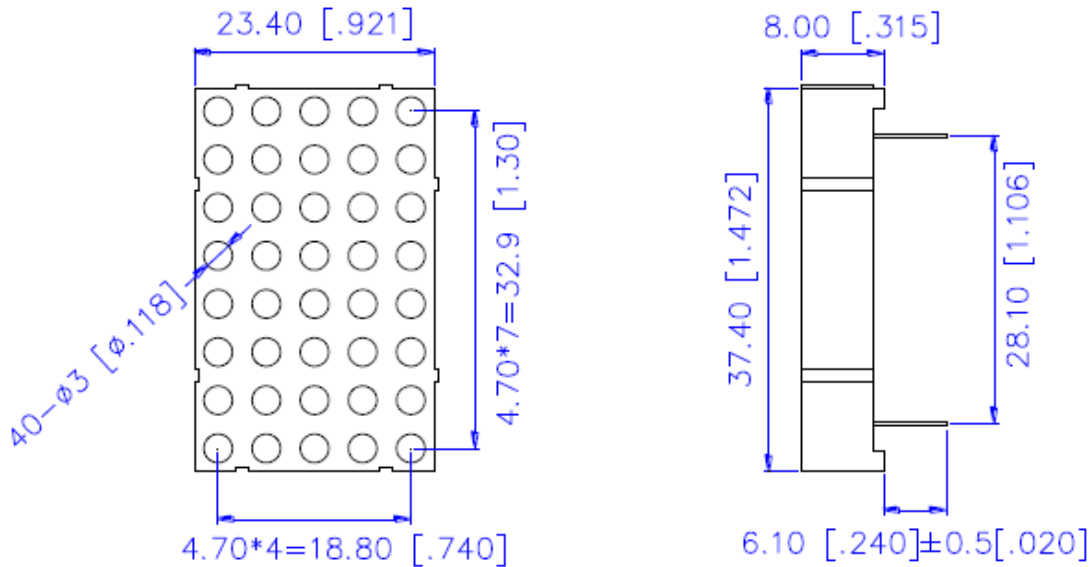

### Notes:

1. Dimensions in millimeters [inch], and tolerance is  $\pm 0.25$  [0.010] and angle is  $\pm 1^\circ$  unless otherwise noted.
2. Bending  $\leq$  Length\*1%
3. All pins are  $\phi 0.50$  [0.020]  $\pm 0.1$  [0.004]
4. Specifications subject to change without notice.





**Device Selection Guide**

Model Number	Chip		Description
	Material	Emitting Color	
PDM58140C-W01	InGaN	White	Common Cathode
PDM58140A-W01			Common Anode

**Absolute Maximum Ratings at Ta=25°C**

Parameter	Symbol	Rating	Unit
Power Dissipation per Dice	PAD	114	mW
Derating Liner from 25°C per Dice	--	0.4	mA/°C
Continuous Forward Current Per Dice	IAF	30	mA
Peak Current Per Dice (duty cycle 1/10, 1KHz)	IPF	100	mA
Reverse Voltage Per Dice	VR	5	V
Electrostatic Discharge (HBM)	ESD	1500	V
Operating Temperature	Topr		°C
Storage Temperature	Tstg		°C

**Typical Electrical and Optical Characteristics at Ta=25°C**

Parameter	Symbol	Chip	Min.	Typ.	Max.	Unit	Condition
Forward Voltage Per Segment	VF	W01	--	3.2	3.8	V	IF=20mA
Luminous Intensity Per Segment	Iv	W01	--	200	--	mcd	IF=10mA
Chromaticity Coordinates (Tolerance: ±0.01)	X/Y	W01	--	0.27/.025	--	nm	IF=10mA
Reverse Current	IR		--	--	50	µA	VR=5V
Luminous Intensity Matching Ratio	Iv-m		--	--	2:1	--	IF=10mA

**Typical Electrical/Optical Characteristic Curves**

( $T_a = 25^{\circ}\text{C}$  Unless Otherwise Noted)

**Fig 1. Forward Current Vs. Ambient Temperature**

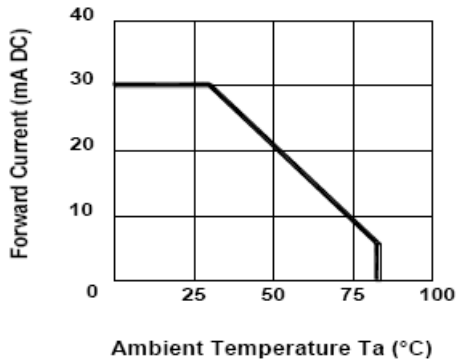

**Fig 2. Forward Current Vs. Forward Voltage**

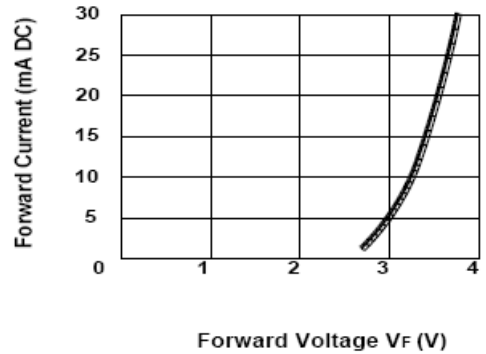

**Fig 3. Relative Intensity Vs. Forward Current**

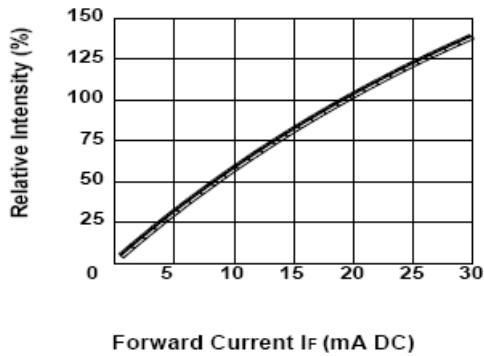

**Fig 4. Peak Forward Voltage Vs. Forward Current (100us test pulse, 1% duty cycle)**

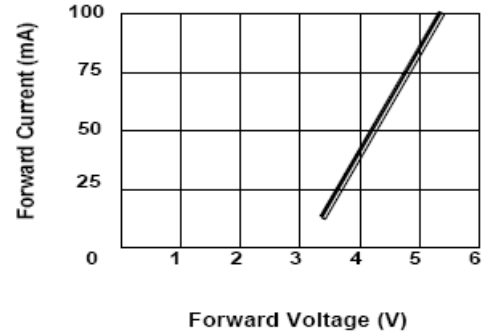

**Fig 5. Relative Intensity Vs. Wavelength**

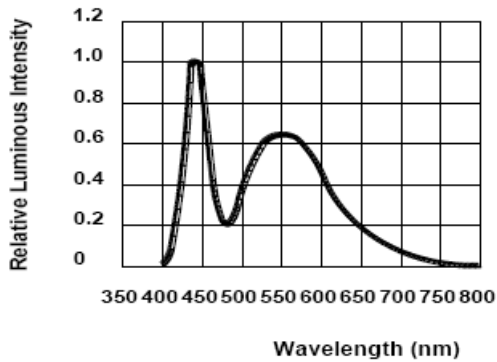



**Luminous General lv Bin Grade (IF = 10mA)**

A	B	C	D	E	F	G	H	J	K	L	M
0.627	0.816	1.062	1.382	1.797	2.337	3.039	3.952	5.138	6.681	8.686	11.293
0.815	1.061	1.381	1.796	2.336	3.038	3.951	5.137	6.680	8.685	11.292	14.681
N	P	Q	R	S	T	U	V	W	X	Y	1
14.682	19.088	24.815	32.261	41.940	54.523	70.881	92.146	119.791	155.730	202.450	263.185
19.087	24.814	32.260	41.939	54.522	70.880	92.145	119.790	155.729	202.449	263.184	342.141
2	3	4	5	6	7	8	9				
342.142	444.786	578.222	751.690	977.198	1270.359	1651.467	2146.908				
444.785	578.221	751.689	977.197	1270.358	1651.466	2146.907	2790.981				

Remark: Unit=mcd

\*Tolerance: ±20%

**Color Rank Limits (IF=10mA)**

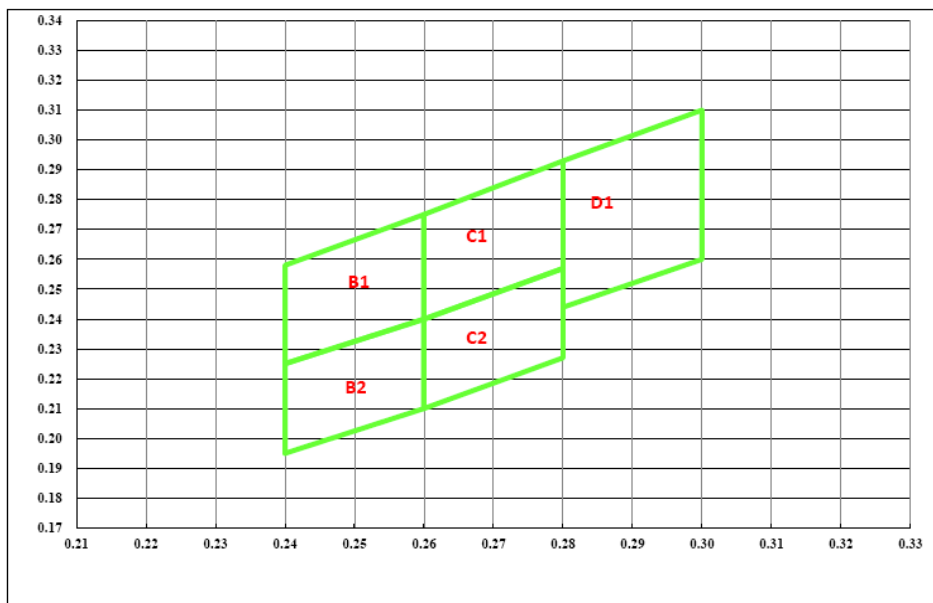

B1				
X	0.240	0.240	0.260	0.260
Y	0.225	0.258	0.275	0.240

B2				
X	0.240	0.240	0.260	0.260
Y	0.195	0.225	0.240	0.210

C1				
X	0.260	0.260	0.280	0.280
Y	0.240	0.275	0.293	0.257

C2				
X	0.260	0.260	0.280	0.280
Y	0.210	0.240	0.257	0.227

D1				
X	0.280	0.280	0.300	0.300
Y	0.244	0.293	0.310	0.260

**All Light-On Segments Feature & Pad Position**

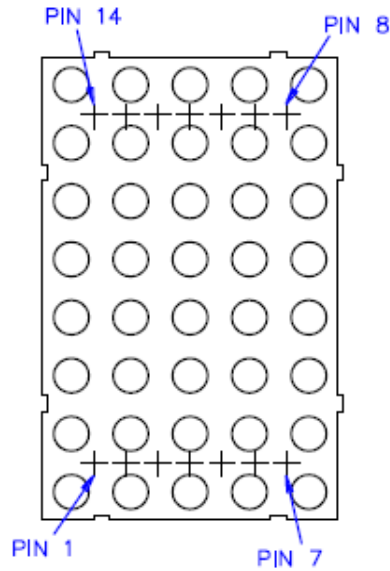

**Internal Circuit Diagram**

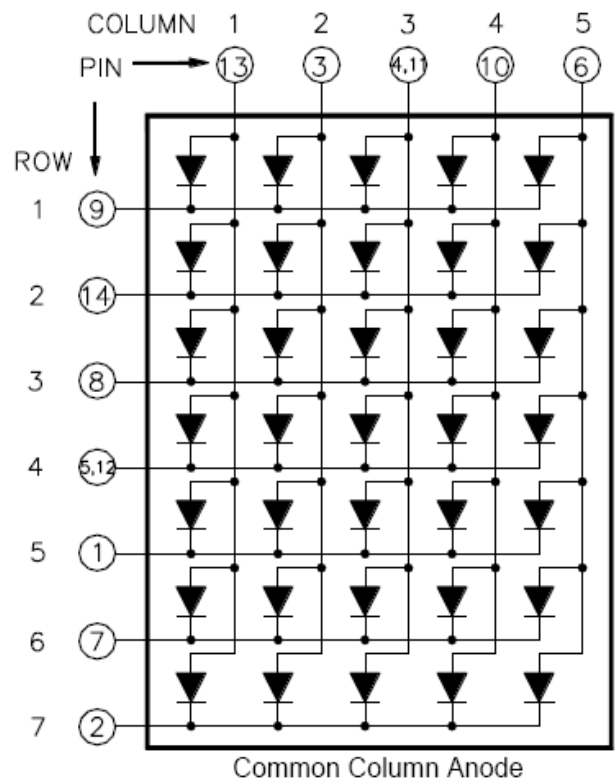
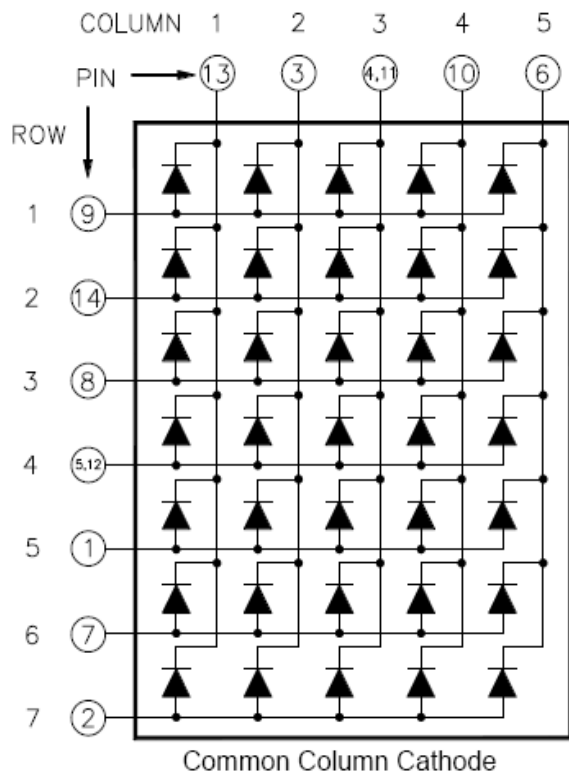

**Precautions for Use**

1. Recommended soldering conditions

1.1. Wave soldering

Basic SPEC is  $\leq 5$ sec. When 260°C. If temperature is higher, time should be shorter (+10°C → -1sec.).

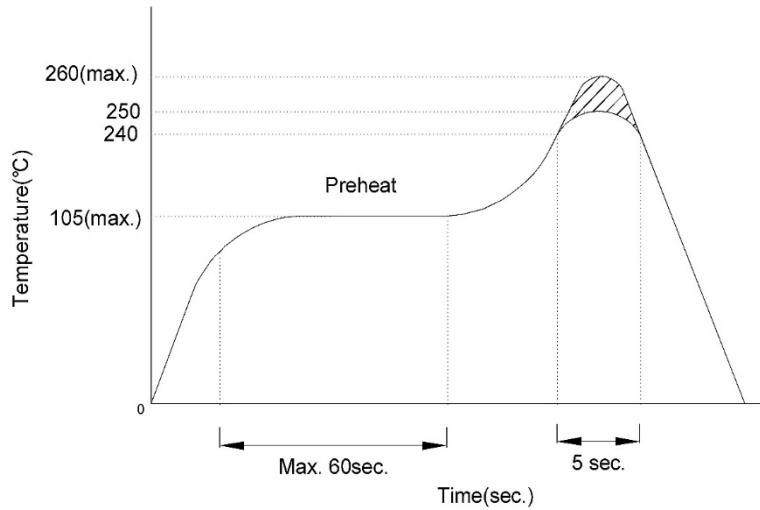

1.2. Soldering Iron:

Power dissipation of iron should be smaller than 15W and temp should be controllable. Soldering temperature should be under 260°C, time  $\leq 3$ sec.

### *Packing Dimensions*

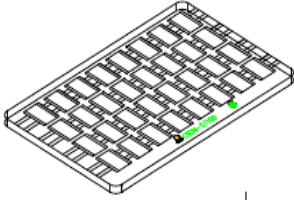

1 Tray From Box = 32 PCS  
Tray Size:  
L300 x W190 x H18mm

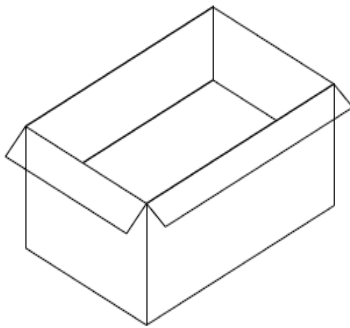
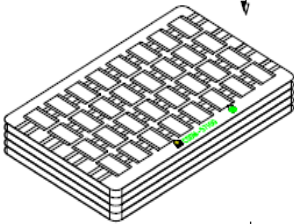

12 Trays Per Inner Box  
Q'TY: 384 PCS.  
Box Size:  
L300 x W205 x H240mm

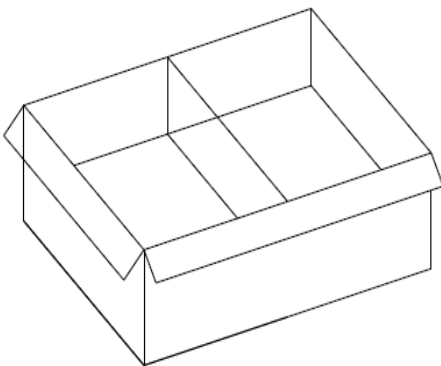

2 Inner Boxes Per Carton.  
Total Q'TY: 768 Pcs  
Carton Size:  
L431 x W320 x H252mm