

ES220-CS

C246
Q370
H310



8th/9th Gen Intel® Core™
Compact Embedded System

KEY FEATURES



Two HDMI 2.0 @60Hz

2 x HDMI 2.0 Supports 4K resolution @60Hz

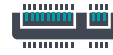

Triple Storage

1 x M.2 SSD + 2 x 2.5" SSD (option)



DDR4

2 x DDR4 SODIMM up to 64GB



RAID Support

RAID support NAS/Server application



Rich I/O

2 x Intel GbE, 4 x USB 3.1, 2 x USB 2.0, 2 x COM



PANEL

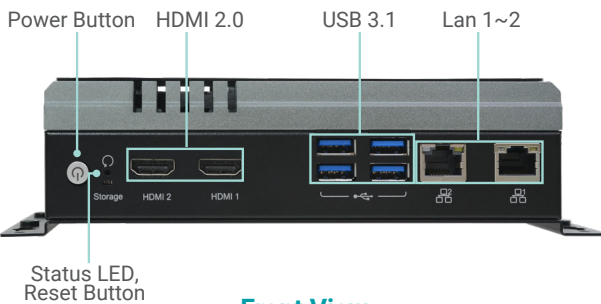

Front View
ES220-CS (1 Storage)

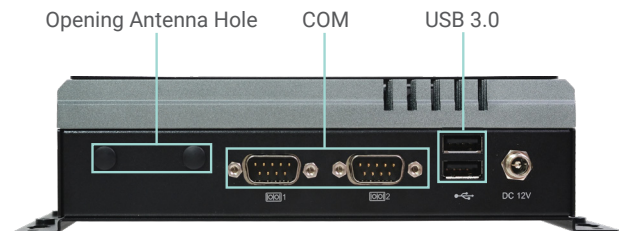

Rear View
ES220-CS (1 Storage)



Front View
ES220-CS (3 Storage)



Rear View
ES220-CS (3 Storage)

DIMENSIONS

1 Storage (1x m.2 SSD)

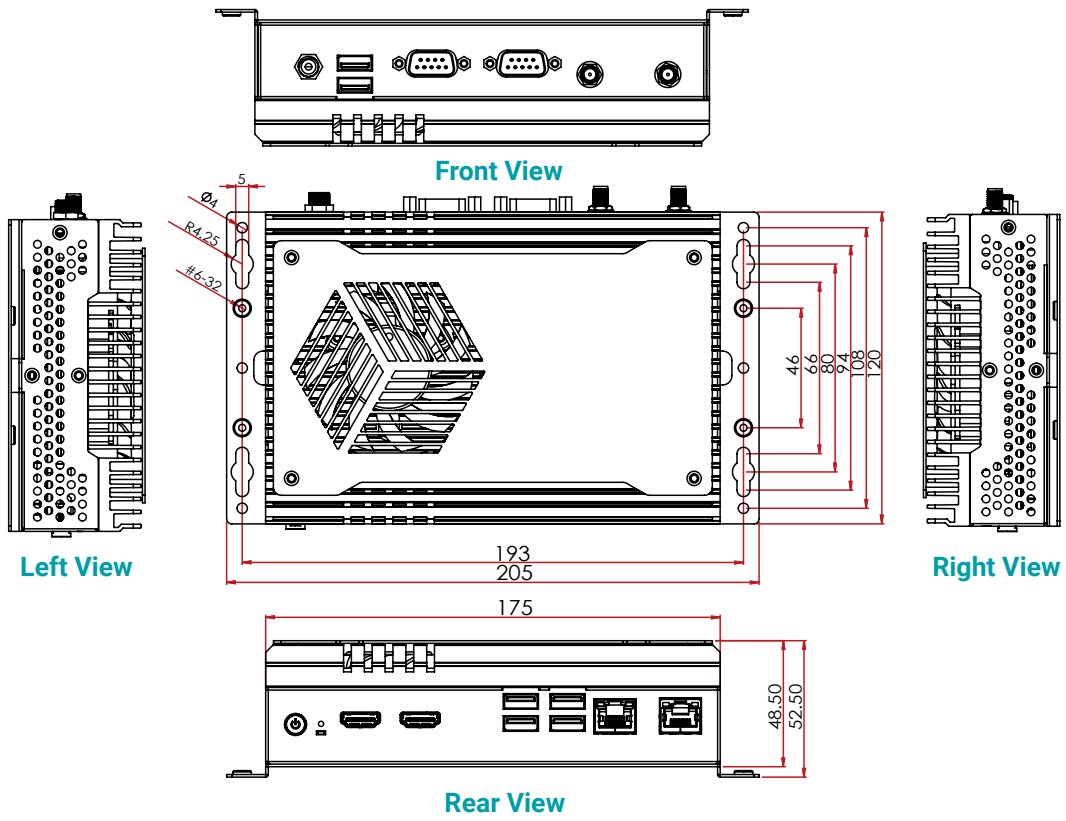

3 Storage (1x m.2 SSD + 2x 2.5" SSD)

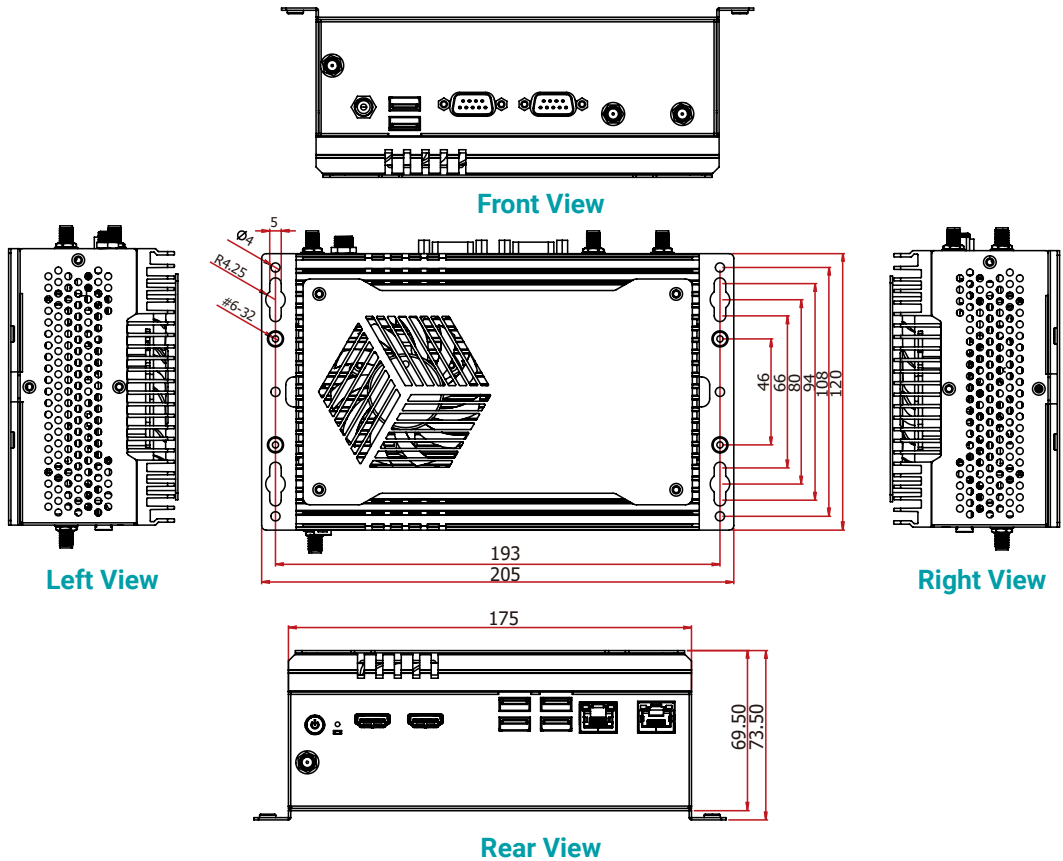

WALL MOUNTING

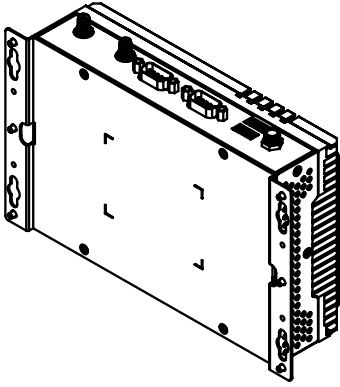

WALL MOUNT

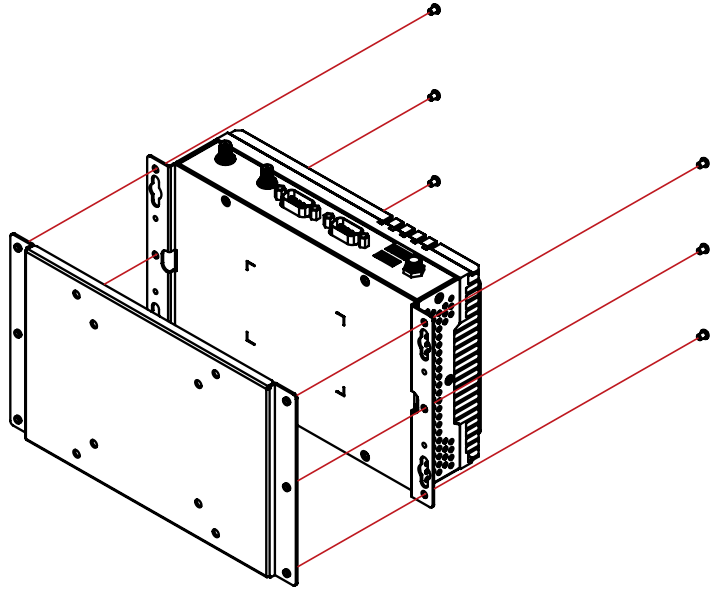

VESA MOUNT

SPECIFICATION

SYSTEM	Processor	8th Gen Intel® Core™ Processors, LGA 1151 Socket Intel® Core i7-8700T Processor (6C/12T; Max speed 4.0 GHz; TDP 35W) Intel® Core i5-8500T Processor (6C/6T; Max speed 3.5GHz; TDP 35W) Intel® Core i3-8100T Processor (4C/4T; Max speed 3.1GHz; TDP 35W) Intel® Pentium G5400T Processor (2C/4T; Max speed 3.1GHz; TDP 35W) Intel® Pentium G4900T Processor (2C/2T; Max speed 2.9GHz; TDP 35W) 9th Gen Intel® Core™ Processors, LGA 1151 Socket Intel® Core i7-9700TE Processor (8C/8T; Max speed 3.6GHz; TDP 35W) Intel® Core i5-9500TE Processor (6C/6T; Max speed 3.6GHz; TDP 35W) Intel® Core i3-9100TE Processor (4C/4T; Max speed 3.2GHz; TDP 35W)
	Chipset	Intel® C246/Q370/H310 Chipset
	Memory	2 x 260-pin SODIMM up to 64GB (ECC : C246 only) Dual Channel DDR4 2666MHz
	BIOS	Insyde SPI 128Mbit
GRAPHICS	Controller	Intel® HD Graphics
	Feature	OpenGL 4.5, DirectX 12, OpenCL 2.1 HW Decode: AVC/H.264, MPEG2, VC1/WMV9, JPEG/MJPEG, HEVC/H265, VP8, VP9 HW Encode: AVC/H.264, MPEG2, JPEG, HEVC/H265, VP8, VP9
	Display	2 x HDMI 2.0 HDMI: resolution up to 4096x2160 @ 60Hz
	Dual Displays	2 x HDMI 2.0
STORAGE	Internal	2 x 2.5" SATA bay (optional) support RAID 0/1
EXPANSION	Interface	1 x M.2 2280 M key (PCIe x4/SATA 3.0) 1 x M.2 2230 E key (PCIe x1/USB2.0), WiFi
ETHERNET	Controller	2 x Intel® I219/I210IT (10/100/1000Mbps) (Support Intel® iAMT)
LED	Indicators	1 x Power LED 1 x HDD LED
FRONT I/O	Ethernet	2 x GbE (RJ-45)
	USB	4 x USB 3.1 (type A)
	Buttons	1 x Power Button 1 x Reset Button
	Display	2 x HDMI
REAR I/O	Serial	2 x RS232/RS422/RS485 (DB9) or 1 x RS232/RS422/RS485 (DB9)(COM1) + 1 x 8bit DIO (DB9)
	USB	2 x USB 2.0 (type A)
	Wi-Fi Antenna	2 x Opening Antenna Hole
WATCHDOG TIMER	Output & Interval	System Reset, Programmable via Software from 1 to 255 Seconds
SECURITY	TPM	TPM2.0 (option)
POWER	Type	12V DC-in jack lockable External power brick AC Power 100-250V, 50/60Hz
OS SUPPORT		Windows 10 IoT Enterprise 2019 LTSC + RS5 Windows 10 Professional
MECHANISM	Construction	Metal + Aluminum
	Mounting	Wall mount VESA mount 75x75/10x10cm (optional)
	Dimensions (W x H x D)	175 x 48.5 x 120mm (1 Storage: 1 x m.2 SSD) 175 x 73.5 x 120mm (3 Storage: 1 x m.2 SSD + 2x 2.5" SSD)
	Weight	1.315 kg (1 Storage: 1 x m.2 SSD) 1.665 kg (3 Storage: 1 x m.2 SSD + 2 x 2.5" SSD)
COOLING	Fan	Active Fan
ENVIRONMENT	Operating Temperature	-5° to 45° C
	Storage Temperature	-20° to 60° C
	Acoustic level	Full load 36dB @op. temp. 45° C Full load 30dB @op. temp. 25° C Idle Mode 26dB @op. temp. 45° C Idle Mode 21dB @op. temp. 25° C
	Relative Humidity	5 to 90% RH
STANDARDS AND CERTIFICATIONS	Certification	FCC, CE Class B, ROHs, WEEE

ORDERING INFORMATION

Model Name	Part Number	Description
ES220-CS	750-ES2200-000G	ES220-CS, CS251-H310, 2HDMI, 2LAN, 2COM, F/G SYSTEM, RoHS
ES220-CS	750-ES2200-100G	ES220-CS, CS251-Q370, 2HDMI, 2LAN, 2COM, F/G SYSTEM, RoHS
ES220-CS	750-ES2200-200G	ES220-CS, CS251-C246, 2HDMI, 2LAN, 2COM, F/G SYSTEM, RoHS
ES220-CS	750-ES2200-300G	ES220-CS, CS251-H310, 2HDMI, 2LAN, 2OM, 2x 2.5"bay, F/G SYSTEM, RoHS
ES220-CS	750-ES2200-400G	ES220-CS, CS251-Q370, 2HDMI, 2LAN, 2COM, 2x 2.5"bay, F/G SYSTEM, RoHS
ES220-CS	750-ES2200-500G	ES220-CS, CS251-C246, 2HDMI, 2LAN, 2COM, 2x 2.5"bay, F/G SYSTEM, RoHS

OPTIONAL ITEMS

Optional Items	Part Number	Description
CPU	143-101805-500G	i7-9700TE, 1.8GHz to 3.8GHz, 8C8T, 12M cache, TDP 35W
	143-10220G-500G	i5-9500TE, 2.2GHz to 3.6GHz, 6C6T, 9M cache, TDP 35W
	143-10220E-500G	i3-9100TE, 2.2GHz to 3.2GHz, 4C4T, 6M cache, TDP 35W
	143-10240A-500G	i7-8700T, 2.4GHz to 4GHz, 6C12T, 12M cache, TDP 35W
	143-102104-501G	i5-8500T, 2.1GHz to 3.5GHz, 6C6T, 9M cache, TDP 35W
	143-103105-500G	i3-8100T, 3.1GHz, 4C4T, 6M cache, TDP 35W
	143-103103-500G	G5400T, 3.1GHz, 2C4T, 4M cache, TDP 35W
	143-112900-500G	G4900T, 2.9GHz, 2C4T, 2M cache, TDP 35W
Memory	138-540002-106G	4GB DDR4 2666Mhz SO-DIMM 1Rx8 512Mx8 CL19 1.2V
	138-580004-102G	8GB DDR4 2666Mhz SO-DIMM 1Rx8 1Gx8 CL19 1.2V
	138-5G0163-102G	16GB DDR4 2666Mhz SO-DIMM 2Rx8 1Gx8 CL19 1.2V
	TBD	32GB DDR4 2666Mhz SO-DIMM 2Rx8 1Gx8 CL19 1.2V
	138-540002-107G	4GB DDR4 2666Mhz ECC-SO-DIMM 1Rx8 512Mx8 CL19 1.2V (C246 only)
	138-580004-103G	8GB DDR4 2666Mhz ECC-SO-DIMM 1Rx8 1Gx8 CL19 1.2V (C246 only)
	TBD	16GB DDR4 2666Mhz ECC-SO-DIMM 1Rx8 1Gx8 CL19 1.2V (C246 only)
	TBD	32GB DDR4 2666Mhz ECC-SO-DIMM 1Rx8 1Gx8 CL19 1.2V (C246 only)
OS	921-151310-000G	Win10 IoT Ent 2019 LTSC MultiLang High End EPKEA
	921-151320-000G	Win10 IoT Ent 2019 LTSC MultiLang High End PKEA
	921-151340-000G	Win10 IoT Ent 2019 LTSC MultiLang High Value EPKEA
	921-151330-000G	Win10 IoT Ent 2019 LTSC MultiLang High Value PKEA
	642-000W10-000G	Win Pro 10 64Bit English 1pk DSP OEI DVD version 1809
Adapter	671-110006-100G	Power Adapter AC/DC 100W 12V, inlet C14
	TBD	Power Adapter AC/DC 160W 12V, inlet C14
Power Cord	332-700010-201G	Power Cord US 3pin 1830mm Length
	A81-004003-000G	Power Cord EU 2pin 1830mm Length
	A81-000001-000G	Power Cord China 3pin 1830mm Length
	332-054034-005G	Power Cord Japan 3pin 1830mm Length, with PSE logo label on cable (for worldwide)
	A81-004056-000G	Power Cord Japan 3pin 2000mm Length, with PSE logo mark on inlet plug (for Japan)
	A81-004031-007G	DC Cord UL 1185 5.5*2.5*9.5mm with Nut to stripped and tinned; L1000mm
M.2 WIFI	761-OPS150-001G	1x intel M.2 2230 AC 3168.NGWG 802.11abgn/ac 1T1R + Bluetooth 4.2, 2x MHF4 to SMA cable 200mm 2x dipole antenna 1x M2x4mm screw
	TBD	1x Intel® Wireless-AC 9260, 2230, 2x2 AC+BT, Gigabit No vPRO 2x MHF4 to SMA cable 200mm 2x dipole antenna 1x M2x4mm screw

Optional Items	Part Number	Description
VESA MOUNT	TBD	1x VESA mount bracket for ES220-CS, SGCC 1.2T, Black coating 6x Screw P/W #6-32 L=6mm OD=6.6mm Zn coating 4x M.4*10mm w/spring washer
M.2 SSD	638-703218-100G	32GB, M.2 2280 SSD, SATA3 B+M Key, MLC
	TBD	64GB, M.2 2280 SSD, SATA3 B+M Key, MLC
	638-712811-100G	128GB, M.2 2280 SSD, SATA3 B+M Key, MLC
	638-725615-100G	256GB, M.2 2280 SSD, SATA3 B+M Key, MLC
	638-712818-100G	128GB, M.2 2280 SSD, SATA3 B+M Key, 3D TLC, PE: 3K
	638-725614-100G	256GB, M.2 2280 SSD, SATA3 B+M Key, 3D TLC, PE: 3K
	638-751205-100G	512GB, M.2 2280 SSD, SATA3 B+M Key, 3D TLC, PE: 3K
	638-701T01-100G	1TB, M.2 2280 SSD, SATA3 B+M Key, 3D TLC, PE: 3K
	638-712816-110G	128GB, M.2 2280, PCIe Gen3x4, M-Key, 3D TLC, PE: 3K
	638-725608-100G	256GB, M.2 2280, PCIe Gen3x4, M-Key, 3D TLC, PE: 3K
	TBD	512GB, M.2 2280, PCIe Gen3x4, M-Key, 3D TLC, PE: 3K
	TBD	1TB, M.2 2280, PCIe Gen3x4, M-Key, 3D TLC, PE: 3K
2.5" SSD	635-600322-1A0G	32GB, 2.5" SSD, SATA3, MLC
	635-600644-100G	64GB, 2.5" SSD, SATA3, MLC
	635-601282-1E0G	128GB, 2.5" SSD, SATA3, MLC
	635-602562-121G	256GB, 2.5" SSD, SATA3, MLC
	635-605122-130G	512GB, 2.5" SSD, SATA3, MLC
	635-601286-110G	128GB, 2.5" SSD, SATA3, 3D TLC, PE: 3K
	635-602566-150G	256GB, 2.5" SSD, SATA3, 3D TLC, PE: 3K
	635-605126-140G	512GB, 2.5" SSD, SATA3, 3D TLC, PE: 3K
	635-610006-110G	1TB, 2.5" SSD, SATA3, 3D TLC, PE: 3K

PACKING LIST

1 ES220-CS system unit with wallmount
Adapter 12V 60W (option)
Power Cord 1830mm (option)
VESA mounting kit (option)