

305/315/355 SERIES



Card Edge Connectors 0.156" (3.96mm) Pitch

Features:

- 0.156" (3.96mm) contact spacing x 0.140" (3.56mm) row spacing
- Accepts 0.062" (1.57mm) nominal thickness P.C. board
- Low profile insulator body, 0.470" (11.94mm)
- Contact termination options include P.C. tail, wire hole, extender board bends
- Dual row configuration
- Large variety of mounting options
- Accepts between contact and in-contact polarizing keys
- Pre-assembled card guides are available
- RoHS Compliant & UL Certified

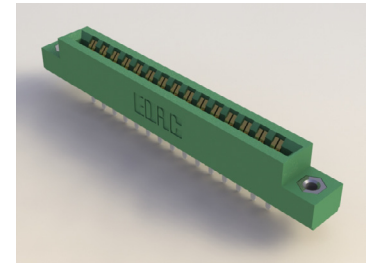

Specifications:

Insulator Material	UL 94V-0 Thermoplastic Polyester
Contact Material	Copper Alloy
Contact Plating	Gold Plating on mating area and Tin Plating on tails with Nickel underplating all over
Current Rating	5 amps
Contact Resistance	10 milliohms maximum
Dielectric Withstanding Voltage	1800 V AC rms at sea level between adjacent contacts
Insulation Resistance	5000 megaohms minimum
Operating Temperature	-40°C to +105°C
Insertion Force	16 oz (4.45 N) maximum per contact pair when tested with .070" (1.78mm) thick gauge
Withdrawal Force	1 oz (0.28 N) minimum per contact pair when tested with .054" (1.37mm) thick gauge

Example Part Number: **305-056-521-202**

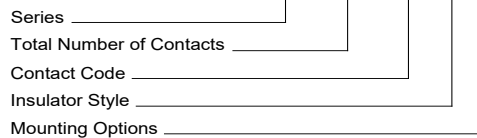

Series:	Insulator Color:	Card Slot Length:
305	Green	Standard Length per MIL-C-21097
315	Green	.020" (0.51mm) Shorter than Standard
355	Black	Standard Length per MIL-C-21097

Total Number of Contacts:	Contact Rows:
012, 014, 086	Dual Row

Contact Code:	Description:	Tail Size:	Tail Length "G":
500	Wire Hole	.087" x .015" (2.21 x 0.38)	.282" (7.16)
520	P.C. Tail	.046" x .015" (1.17 x 0.38)	.213" (5.41)
521	P.C. Tail	.037" x .015" (0.94 x 0.38)	.125" (3.18)
555	EXTENDER BOARD BEND	(Code 500 Contacts)	
556	EXTENDER BOARD BEND	(Code 520 Contacts)	

Insulator Style:	Description:
2	.295" (7.49) Card Slot Depth
5	.330" (8.38) Card Slot Depth

Mounting Options:

01	No Mounting Lug
02	Ø.128" (Ø3.25mm) Mounting Holes
03	Ø.116" (Ø2.95mm) I.D. Floating Eyelets
04	Ø.156" (Ø3.96mm) Mounting Holes
07	M3-0.5 Metric Threaded Inserts
08	#4-40 Unified Threaded Inserts
12	Ø.128" (Ø3.25mm) Side Mounting Holes
58	.468" (11.89mm) Offset Card Guides
68	.344" (8.74) Offset Card Guides
78	In-Line Card Guides 2.750" (69.85mm) Long

Description:

IN-CONTACT POLARIZING KEY
P/N 307-240-328



BETWEEN CONTACT POLARIZING KEY
P/N 306-240-318

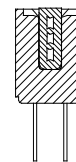

Ordering Code Notes:

- 1) All connector sizes up to 86 contacts dual row are available upon request.
- 2) For details of the extender board bends refer to next pages.
- 3) Consult with EDAC Inc. regarding single row configuration and wire wrap tail options
- 4) Insulator style code 5 is available for the 305 and 355 series upon request.
- 5) For details of the mounting options refer to next pages.

305/315/355 SERIES



Card Edge Connectors 0.156" (3.96mm) Pitch

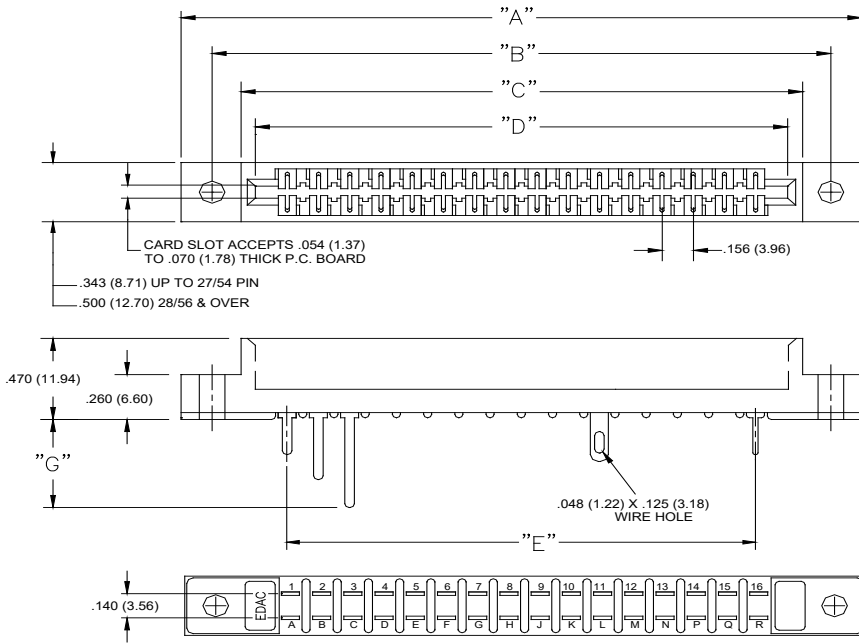

INSULATOR STYLE CODE 2

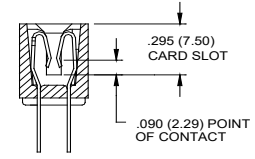

INSULATOR STYLE CODE 5

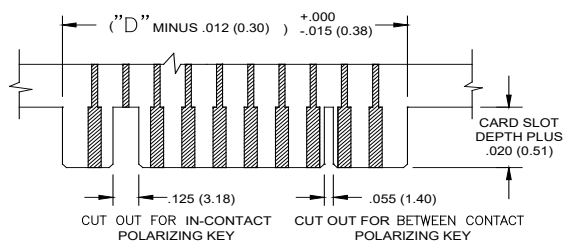
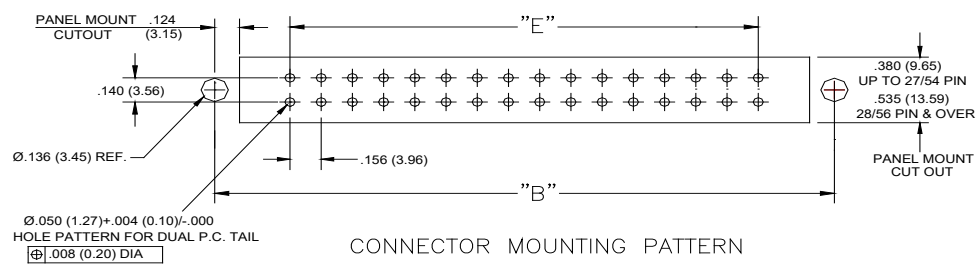
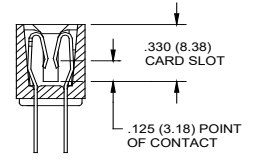

NUMBER OF CONTACTS	"A"		"B"		"C"		"D"				"E"	
	305,355		315									
	inch	mm	inch	mm	inch	mm	inch	mm	inch	mm	inch	mm
12	1.842	46.79	1.532	38.91	1.246	31.65	1.100	27.94	1.080	27.43	0.780	19.81
20	2.466	62.64	2.156	54.76	1.870	47.50	1.724	43.79	1.704	43.28	1.404	35.66
24	2.778	70.56	2.468	62.69	2.182	55.42	2.036	51.71	2.016	51.21	1.716	43.59
30	3.246	82.45	2.936	74.57	2.650	67.31	2.504	63.60	2.484	63.09	2.184	55.47
36	3.714	94.34	3.404	86.46	3.118	79.20	2.972	75.49	2.952	74.98	2.652	67.36
44	4.338	110.19	4.028	102.31	3.742	95.05	3.596	91.34	3.576	90.83	3.276	83.21
48	4.65	118.11	4.340	110.24	4.054	102.97	3.908	99.26	3.888	98.76	3.588	91.14
50	4.806	122.07	4.496	114.20	4.210	106.93	4.064	103.23	4.044	102.72	3.744	95.10
56	5.274	133.96	4.964	126.09	4.678	118.82	4.532	115.11	4.512	114.60	4.212	106.98
60	5.586	141.88	5.276	134.01	4.990	126.75	4.844	123.04	4.824	122.53	4.524	114.91
72	6.522	165.66	6.212	157.78	5.926	150.52	5.780	146.81	5.760	146.30	5.460	138.68
86	7.614	193.40	7.304	185.52	7.018	178.26	6.872	174.55	6.852	174.04	6.552	166.42

305/315/355 SERIES



Card Edge Connectors 0.156" (3.96mm) Pitch

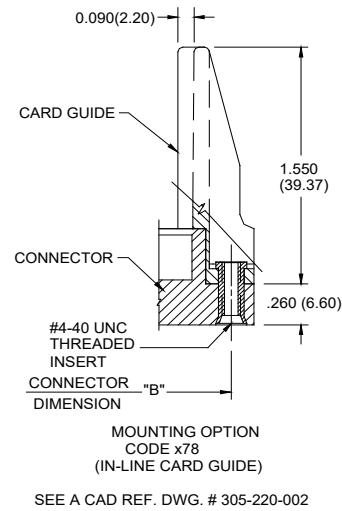
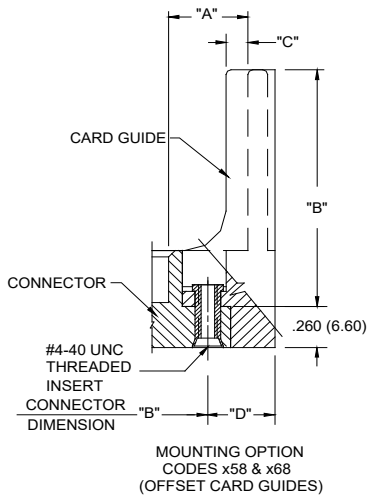
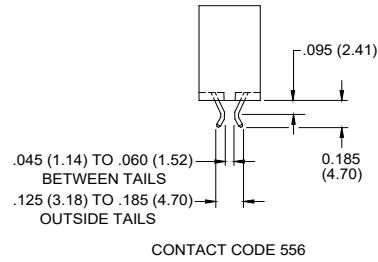
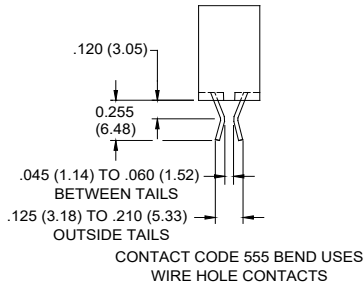
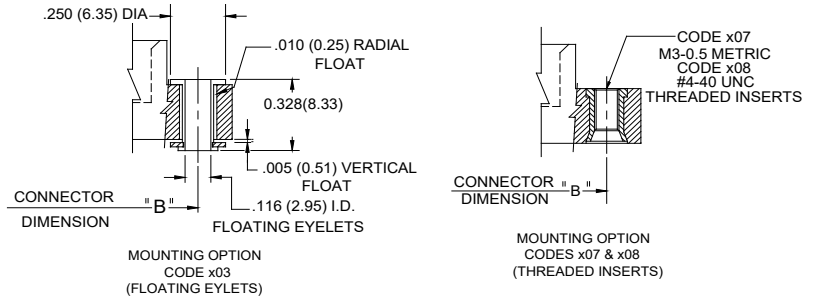
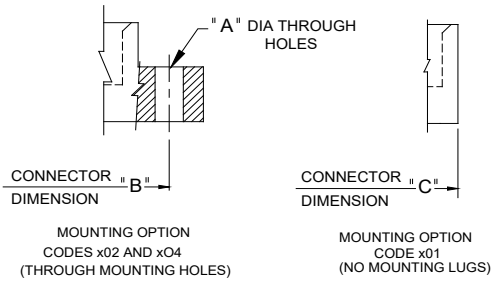

CODE X02 AND X04- THROUGH MTG. HOLES			CODES X58 AND X68- OFFSET CARD GUIDES		
	CODE X02	CODE X04		CODE X58	CODE X68
"A" DIA.	0.128(3.25)	0.156(3.96)	"A"	0.468(11.89)	0.344(8.74)
CODE X07 AND X08- THREADED INSERTS			"B"	2.755(69.98)	2.505(63.63)
	CODE X07	CODE X08	"C"	0.125(3.18)	0.060(1.52)
INSERT	M3-0.5(METRIC)	#4-40 UNC	"D"	0.423(10.74)	0.242(6.15)