

PLEASE CHECK WWW.MOLEX.COM FOR LATEST PART INFORMATION

Part Number: [0520443645](#)
Status: **Active**
Overview:
Description: 1.25mm (.049") Right Angle, Non-ZIF, Top Contact Style Receptacle, 36 Circuits

Agency Certification

UL E29179

General

Product Family FFC/FPC Connectors
 Series 52044
 Overview ffc_fpc_throughhole
 Product Name N/A

Physical

Circuits (Loaded) 36
 Contact Position Top
 Entry Angle 90° Angle
 Flammability 94V-0
 Mated Height (in) 0.201 In
 Mated Height (mm) 5.10 mm
 Number of Rows 1
 Orientation Right Angle
 PC Tail Length (in) 0.138 In
 PC Tail Length (mm) 3.50 mm
 PCB Retention None
 Packaging Type Tray
 Pitch - Mating Interface (in) 0.049 In
 Pitch - Mating Interface (mm) 1.25 mm
 Polarized to PCB Yes
 Stackable No
 Surface Mount Compatible (SMC) No
 Temperature Range - Operating -40°C to +85°C
 Termination Interface: Style Through Hole
 Wire/Cable Type FFC/FPC

Electrical

Current - Maximum per Contact 0.5A, 1A
 Voltage - Maximum 200V

Material Info

Reference - Drawing Numbers

Packaging Specification SPK-52044
 Product Specification PS-52044-002, RPS-52044-003, RPS-52044-005,
 RPS-52044-006, RPS-52044-008
 Sales Drawing SD-52044-**45

EU RoHS

**ELV and RoHS
 Compliant**
**REACH SVHC
 Contains SVHC: No**
**Halogen-Free
 Status**

China RoHS



Not Reviewed

**Need more information on product
 environmental compliance?**

Email productcompliance@molex.com
 For a multiple part number RoHS Certificate of
 Compliance, [click here](#)

Please visit the [Contact Us](#) section for any
 non-product compliance questions.

Search Parts in this Series
[52044Series](#)

DWG. NO.
SD-52044-***45

無鉛
LEAD FREE

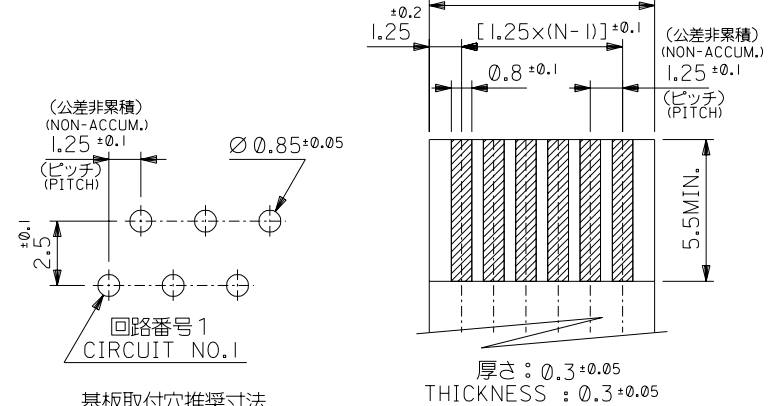
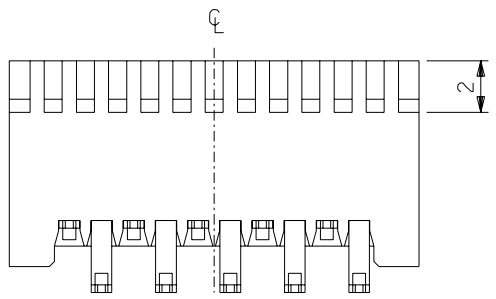
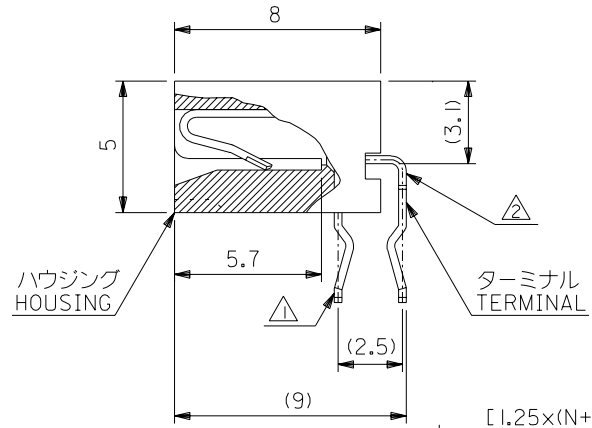
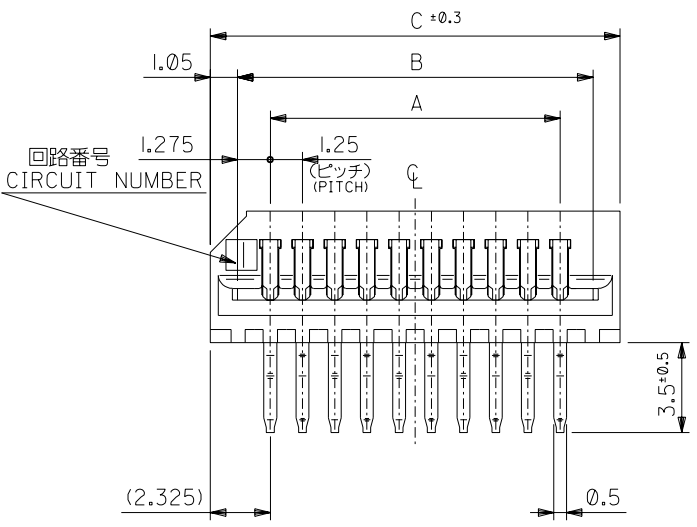

注記 NOTES

- △ 奇数極ソルダーテール。
ODD CIRCUIT SOLDER TAIL.
- △ 偶数極ソルダーテール。
EVEN CIRCUIT SOLDER TAIL.

3. 材質 MATERIAL

ターミナル: リン青銅 (t=0.3)
メッキ: 錫メッキ 0.9 μm 以上
リフロー処理
TERMINAL: PHOSPHOR BRONZE (t=0.3)
PLATING: Sn 0.9 μm MIN.
REFLOW TREATMENT.
ハウジング: PBTP, UL94V-0 (灰色)
HOUSING: PBTP, UL94V-0 (GRAY)

基板取付穴推奨寸法
RECOMMENDED P.C.BOARD HOLE DIM.
(厚さ: 1.6)
(THICKNESS: 1.6)

53.4	51.3	48.75	52044-4045	40
52.15	50.05	47.5	▲ -3945	39
50.9	48.8	46.25	-3845	38
49.65	47.55	45	-3745	37
48.4	46.3	43.75	-3645	36
47.15	45.05	42.5	-3545	35
45.9	43.8	41.25	-3445	34
44.65	42.55	40	-3345	33
43.4	41.3	38.75	-3245	32
42.15	40.05	37.5	-3145	31
40.9	38.8	36.25	-3045	30
39.65	37.55	35	-2945	29
38.4	36.3	33.75	-2845	28
37.15	35.05	32.5	-2745	27
35.9	33.8	31.25	-2645	26
34.65	32.55	30	-2545	25
33.4	31.3	28.75	-2445	24
32.15	30.05	27.5	-2345	23
30.9	28.8	26.25	-2245	22
29.65	27.55	25	-2145	21
28.4	26.3	23.75	-2045	20
27.15	25.05	22.5	-1945	19
25.9	23.8	21.25	-1845	18
24.65	22.55	20	-1745	17
23.4	21.3	18.75	-1645	16
22.15	20.05	17.5	-1545	15
20.9	18.8	16.25	-1445	14
19.65	17.55	15	-1345	13
18.4	16.3	13.75	-1245	12
17.15	15.05	12.5	-1145	11
15.9	13.8	11.25	-1045	10
14.65	12.55	10	-0945	9
13.4	11.3	8.75	-0845	8
12.15	10.05	7.5	-0745	7
10.9	8.8	6.25	-0645	6
9.65	7.55	5	-0545	5
8.4	6.3	3.75	▼ -0445	4
7.15	5.05	2.5	52044-0345	3
C	B	A	ENG. NO.	NO. OF CKT. 極数

単位 DESIGN UNITS	mm	材料 MATERIAL	注記参照 SEE NOTES	材料 MOLEX-JAPAN CO.,LTD. 日本モレックス株式会社
角度 ANGLE	±3°	仕上げ FINISH	— —	REVISE ONLY ON CAD SYSTEM
30以上 OVER	+0.3	適用電線範囲 WIRE RANGE	— —	TITLE 名称
10以上 30未満 UNDER	+0.25	被覆外径 INS. RANGE	— —	1.25 FFC CONN. HS'G ASS'Y R/A. TYPE
未満 10 UNDER	+0.2	DRAWN BY '95/4/24 T.ASAKAWA	CHK'D BY '95/4/24 Y.M.HIRAMOTO	DWG. NO.
一般公差 GENERAL TOLERANCES	記号 LTR	変更内容 REVISION RECORD	DR. CHK. 日付 DATE	尺度 SCALE 5 : 1