



LMS131-10100 Security

LMS1xx

2D LASER SCANNERS

SICK
Sensor Intelligence.



Ordering information

Type	Part no.
LMS131-10100 Security	1051379

Other models and accessories → www.sick.com/LMS1xx



Detailed technical data

Features

Field of application	Security, Outdoor
Light source	Infrared (905 nm)
Laser class	1 (IEC 60825-1 (2007-3))
Aperture angle	270°
Scanning frequency	25 Hz / 50 Hz
Angular resolution	0.25° 0.5°
Heating	Yes
Operating range	0.5 m ... 20 m
Max. range with 10 % reflectivity	18 m
Amount of evaluated echoes	2
Fog correction	Yes

Performance

Response time	≥ 20 ms
Detectable object shape	Almost any
Systematic error	± 30 mm ¹⁾
Statistical error	12 mm ¹⁾
Integrated application	Field evaluation with flexible fields, security conform parameterization, Easy Teach lite and pro
Number of field sets	10 fields
Simultaneous evaluation cases	10

¹⁾ Typical value; actual value depends on environmental conditions.

Interfaces

Serial (RS-232)	✓
Function	AUX
Data transmission rate	9.6 kBaud ... 115.2 kBaud

Ethernet	✓
Function	Host
Data transmission rate	10/100 MBit/s
Protocol	TCP/IP, OPC
CAN bus	✓
Function	Extension of outputs
Switching inputs	4 digital
Switching outputs	3 (2 relay, 1 digital)
Optical indicators	7-segment display (plus 5 LEDs showing device status, contamination warning and initial condition)

Mechanics/electronics

Electrical connection	1 x M12 round connector
Operating voltage	9 V DC ... 30 V DC
Power consumption	Typ. 8 W, heating typ. 35 W
Housing color	Gray (RAL 7032)
Enclosure rating	IP 67 (EN 60529, Section 14.2.7)
Protection class	III (EN 50178 (1997;10))
Weight	1.1 kg
Dimensions (L x W x H)	105 mm x 102 mm x 162 mm

Ambient data

Object remission	2 % ... > 1,000 % (reflectors)
Electromagnetic compatibility (EMC)	EN 61000-6-2:2005 / EN 61000-6-4 (2007-01)
Vibration resistance	EN 60068-2-6 (1995-04)
Shock resistance	EN 60068-2-27 (1993-03)
Ambient operating temperature	-30 °C ... +50 °C
Storage temperature	-30 °C ... +70 °C
Ambient light immunity	40,000 lx

General notes

Note on use	Not suitable for personnel protection
--------------------	---------------------------------------

Dimensional drawing (Dimensions in mm (inch))

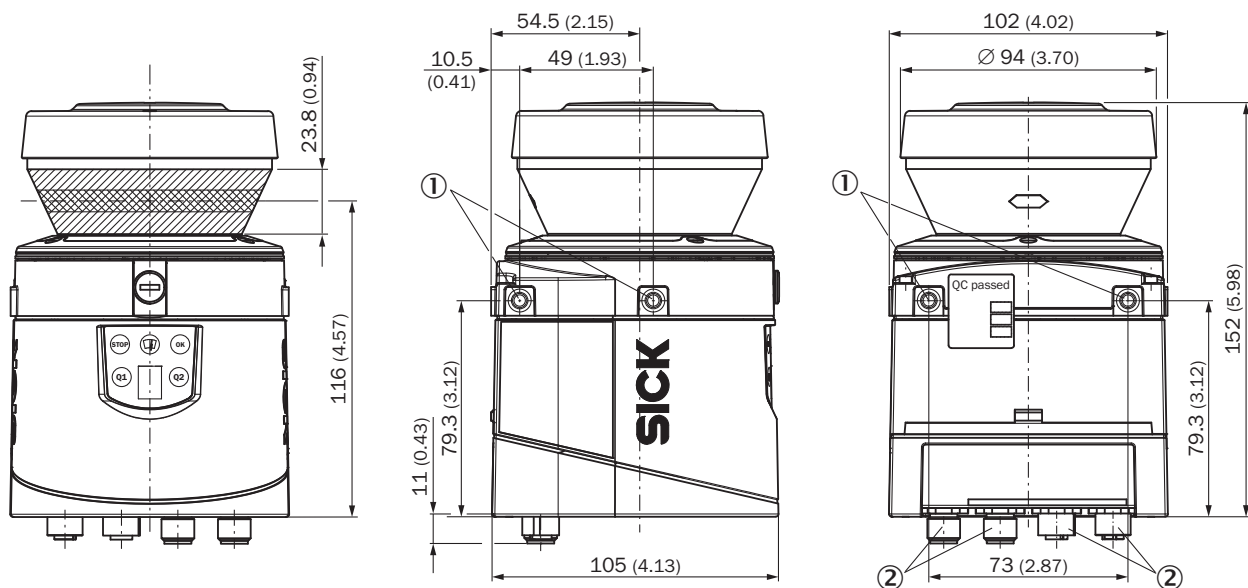

- ① Mounting hole M5 x 7.5
- ② Connector M12

Operating range diagram



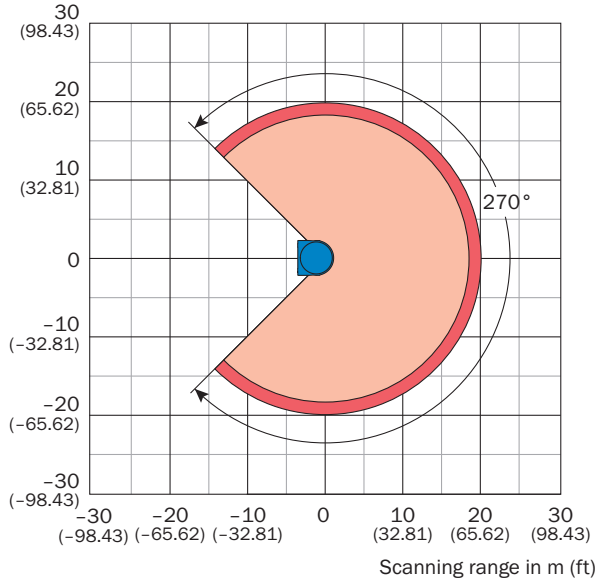





Scanning range in m (ft)

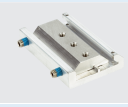
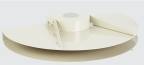
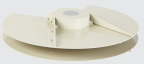

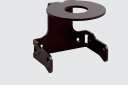
- Scanning range max. 20 m (65.62 ft)
- Scanning range for objects up to 10 % remission 18 m (59.06 ft)

Recommended accessories

Other models and accessories → www.sick.com/LMS1xx

	Brief description	Type	Part no.
Terminal and alignment brackets			
	Quick-action lock system for weather hood 190°/270°	Quick release	2046989
Device protection (mechanical)			
	Weather hood, 190°	Weather protection cover 190°	2046459
	Weather hood, 270°	Weather protection cover 270°	2046458
Mounting brackets and mounting plates			
	Standard mounting set for 190°/270° weather hood	Mounting bracket	2046025
	1 piece, mounting bracket for rear mounting on wall or machine	Mounting kit 1a	2034324
	1 piece, mounting bracket for rear mounting on wall or machine with protection of optics hood	Mounting kit 1b	2034325
	1 piece, mounting bracket, adjustable lateral axis, only in conjunction with mounting kit 1a (2034324) or 1b (2034325)	Mounting kit 2	2039302
	1 piece, mounting plate, adjustable longitudinal axis, only in conjunction with mounting kit 2 (2039302)	Mounting kit 3	2039303
Plug connectors and cables			
	Head A: female connector, M12, 5-pin, straight, A-coded Head B: cable Cable: shielded, 5 m	Connecting cable (female connector - open)	6036159
	Head A: female connector, M12, 8-pin, straight, A-coded Head B: cable Cable: RS-232, RS-422, shielded, 5 m	Connecting cable (female connector - open)	6036153
	Head A: male connector, M12, 8-pin, straight, A-coded Head B: cable Cable: shielded, 5 m	Connecting cable (male connector-open)	6036155
	Head A: male connector, M12, 4-pin, straight, D-coded Head B: male connector, RJ45, 8-pin, straight Cable: Ethernet, drag chain use, PUR, shielded, 5 m	SSL-2J04-G05ME	6034415

SICK AT A GLANCE

SICK is one of the leading manufacturers of intelligent sensors and sensor solutions for industrial applications. A unique range of products and services creates the perfect basis for controlling processes securely and efficiently, protecting individuals from accidents and preventing damage to the environment.

We have extensive experience in a wide range of industries and understand their processes and requirements. With intelligent sensors, we can deliver exactly what our customers need. In application centers in Europe, Asia and North America, system solutions are tested and optimized in accordance with customer specifications. All this makes us a reliable supplier and development partner.

Comprehensive services complete our offering: SICK LifeTime Services provide support throughout the machine life cycle and ensure safety and productivity.

For us, that is “Sensor Intelligence.”

WORLDWIDE PRESENCE:

Contacts and other locations –www.sick.com