

# Infrared light emitting diode, top view type

## SIR-568ST3F

The SIR-568ST3F has the response speed and luminous output necessary for image transmission in audio-visual applications. It can support almost all types of optical transmission through air, including audio and data transmission. The luminous output is 13 mW and the cutoff frequency is 50 MHz.

### ●Applications

Transmission of images from a video cassette recorder to a television.

Transmission of audio signals between audio devices.

High speed data transmission.

### ●Features

- 1) High luminous output 13 mW.
- 2) Fast response is possible 50 MHz cutoff frequency.

### ●External dimensions (Units: mm)

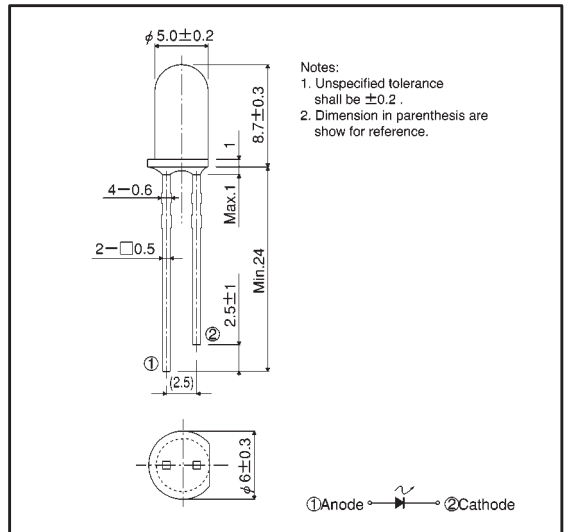

### ●Absolute maximum ratings ( $T_a = 25^\circ\text{C}$ )

Parameter	Symbol	Limits	Unit
Forward current	$I_F$	100	mA
Reverse voltage	$V_R$	4.0	V
Power dissipation	$P_D$	230	mW
Pulse forward current	$I_{FP}^*$	1.0	A
Operating temperature	$T_{opr}$	$-25 \sim +85$	$^\circ\text{C}$
Storage temperature	$T_{stg}$	$-40 \sim +85$	$^\circ\text{C}$

\* Pulse width = 0.1 msec, duty ratio 1%

## ●Electrical and optical characteristics (Ta = 25°C)

Parameter		Symbol	Min.	Typ.	Max.	Unit	Conditions
Optical output		P <sub>o</sub>	—	13	—	mW	I <sub>F</sub> =50mA
Emitting strength		I <sub>E</sub>	18	38	—	mW/sr	I <sub>F</sub> =50mA
Forward voltage		V <sub>F</sub>	—	1.6	2.1	V	I <sub>F</sub> =50mA
Reverse current		I <sub>R</sub>	—	—	10	μA	V <sub>R</sub> =2V
Peak light emitting wavelength		λ <sub>P</sub>	—	850	—	nm	I <sub>F</sub> =20mA
Spectral line half width		Δλ	—	40	—	nm	I <sub>F</sub> =20mA
Half-viewing angle		θ <sub>1/2</sub>	—	±13	—	deg	I <sub>F</sub> =50mA
Response time	Rise time	t <sub>r</sub>	—	8.0	—	ns	I <sub>F</sub> =50mA
	Fall time	t <sub>f</sub>	—	6.0	—	ns	I <sub>F</sub> =50mA
Cut-off frequency		f <sub>c</sub>	—	50	—	MHz	I <sub>F</sub> =30mA DC+20mA p-p

## ●Electrical and optical characteristic curves

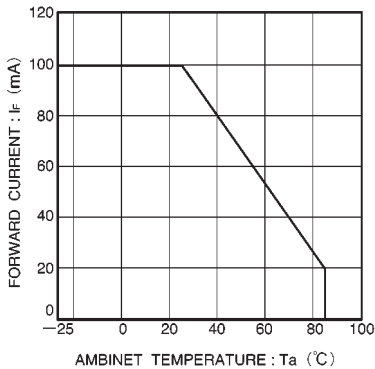

Fig. 1 Forward current falloff

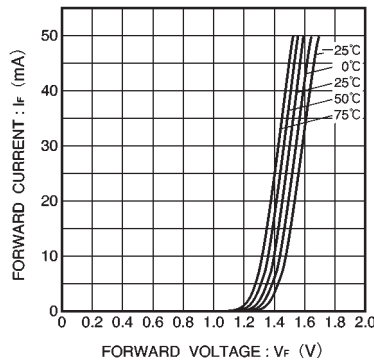

Fig. 2 Forward current vs. forward voltage

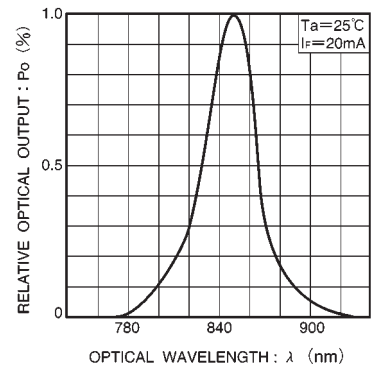

Fig. 3 Wavelength characteristics

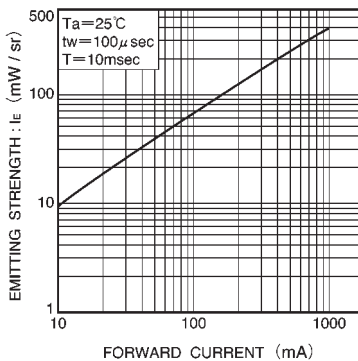

Fig. 4 Emitting strength vs. forward current

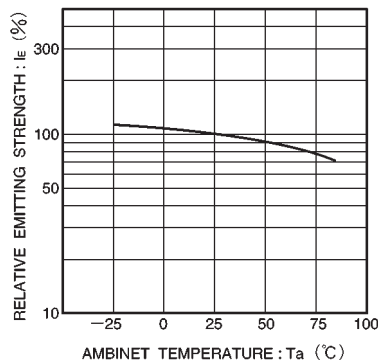

Fig. 5 Relative emitting strength vs. ambient temperature

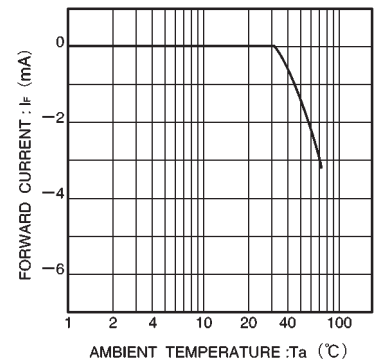

Fig. 6 Frequency characteristics

---

---