

Radiation	Type	Technology	Case
Violet	Standard	InGaN	TO-66

Description	
High-power blue LED-Chip on TO-66 package	
Note: Special packages without standoff available on request	
Applications	
Illumination, safety equipment, automation, biotechnology	

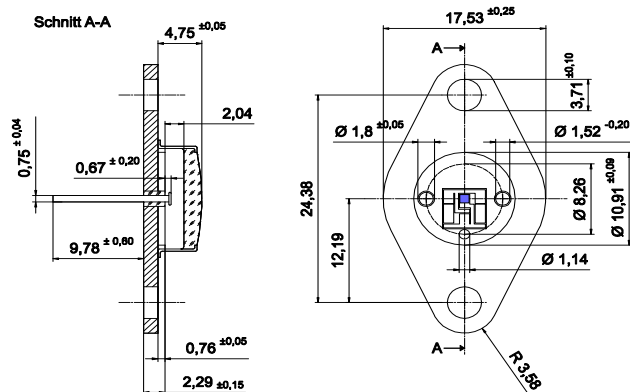

Maximum Ratings

$T_{amb} = 25^{\circ}\text{C}$, unless otherwise specified

Parameter	Test conditions	Symbol	Value	Unit
Forward current (DC)		I_F	500	mA
Operating temperature range		T_{amb}	-40 to +85	$^{\circ}\text{C}$
Storage temperature range		T_{stg}	-40 to +85	$^{\circ}\text{C}$
Junction temperature		T_J	125	$^{\circ}\text{C}$

Optical and Electrical Characteristics

$T_{amb} = 25^{\circ}\text{C}$, unless otherwise specified

Parameter	Test conditions	Symbol	Min	Typ	Max	Unit
Forward voltage	$I_F = 350 \text{ mA}$	V_F		3.1	3.5	V
Forward voltage ¹	$I_F = 500 \text{ mA}$	V_F		3.2		V
Reverse voltage	$I_R = 100 \mu\text{A}$	V_R	5			V
Radiant power	$I_F = 350 \text{ mA}$	Φ_e	120	170		mW
Radiant power ¹	$I_F = 500 \text{ mA}$	Φ_e		240		mW
Peak wavelength	$I_F = 500 \text{ mA}$	λ_p	415	425	435	nm
Spectral bandwidth at 50%	$I_F = 350 \text{ mA}$	$\Delta\lambda_{0.5}$		20		nm
Viewing angle	$I_F = 350 \text{ mA}$	φ		115		deg.
Switching time	$I_F = 350 \text{ mA}$	t_r, t_f		30		ns

¹for information only

Note: All measurements carried out on *EPIGAP* equipment

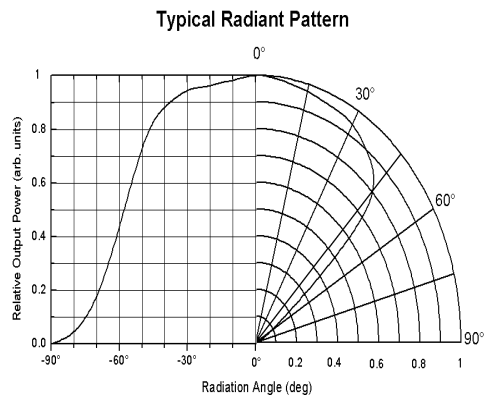
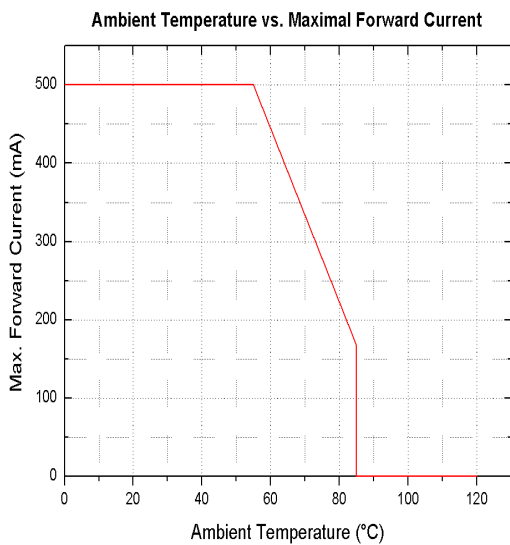
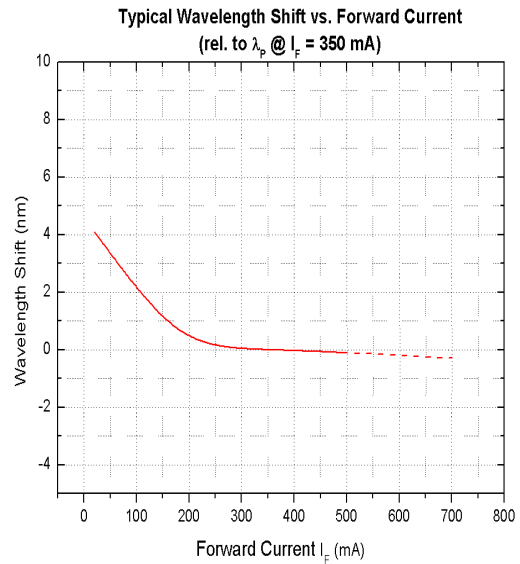
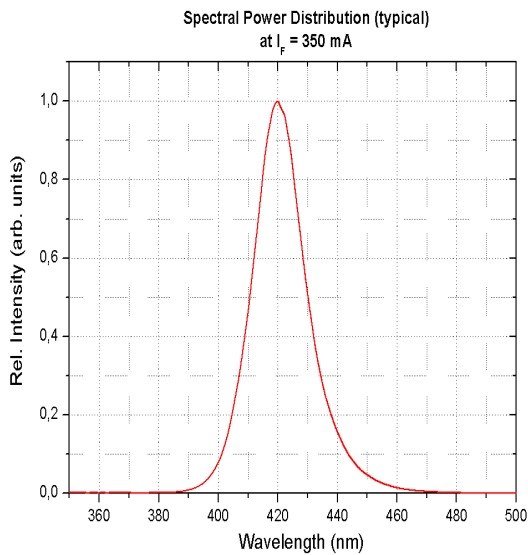
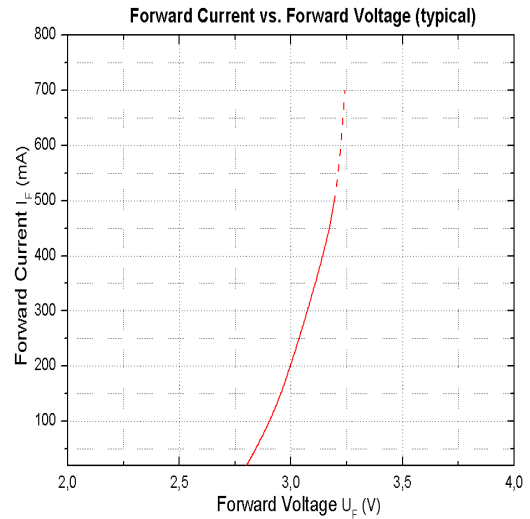
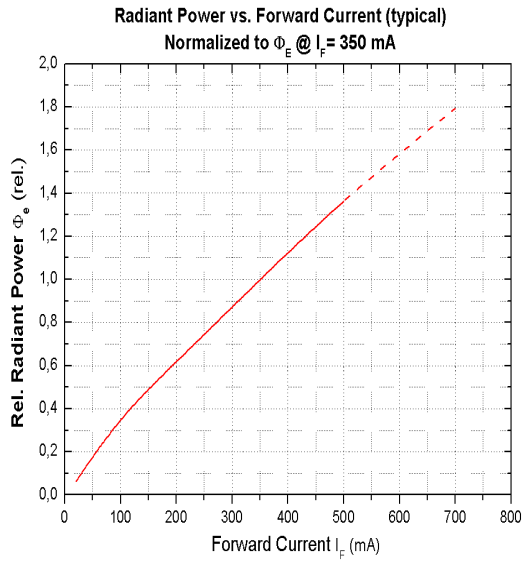

We reserve the right to make changes to improve technical design and may do so without further notice. Parameters can vary in different applications. All operating parameters must be validated for each application by the customers themselves.