



M20S-03140A120, M20E-03140A120

M2000 Standard

MULTIPLE LIGHT BEAM SAFETY DEVICES

SICK
Sensor Intelligence.



Ordering information

System part	Type	Part no.
Sender	M20S-03140A120	1016428
Receiver	M20E-03140A120	1016429

1.) Concerns installation as a replacement part for previous type 2 device in machine: Regarding Machinery Directive 2006/42/EC, Article 1, Paragraph (2a) this type 2 device may only be used as a replacement part for identical PL d / SIL2 devices within the EU if the machine was put into circulation before 2015-05-10. Keep this note with your machine documentation. If the machine is sold on, this note and the information it contains must be passed on to every subsequent buyer. 2.) Concerns installation on new machines: Due to the amendment to the EN/IEC 61496-1 standard, this type 2 device may only be installed on new machines up to PL c / SIL1 as of 2015-05-10.

Other models and accessories → www.sick.com/M2000_Standard



Detailed technical data

Features

Scanning range	0 m ... 25 m, configurable
Low scanning range	0 m ... 6 m
Great scanning range	2 m ... 25 m
Number of beams	3
Beam separation or resolution	400 mm
Response time	8 ms
Synchronization	Optical synchronisation

Safety-related parameters

Type	Type 2 (IEC 61496)
Safety integrity level	SIL1 (IEC 61508) SILCL1 (EN 62061)
Category	Category 2 (EN ISO 13849)
Test rate (internal test)	13 /s (EN ISO 13849) ¹⁾
Maximum demand rate	≤ 8 min ⁻¹ (EN ISO 13849) ²⁾
Performance level	PL c (EN ISO 13849)
PFH_D (mean probability of a dangerous failure per hour)	6.6 x 10 ⁻⁹ (EN ISO 13849)
T_M (mission time)	20 years (EN ISO 13849)
Safe state in the event of a fault	At least one OSSD is in the OFF state.

¹⁾ Internal test. The test rate may not be exceeded if an external test is performed.

²⁾ Between two requirements on a safety-related response of the device, at least 100 internal or external tests must be carried out.

Functions

	Functions	Delivery status
Beam coding	✓	Uncoded
Configurable scanning range	✓	

Interfaces

System connection	Connection type	Hirschmann plug M26, 7-pin
	Permitted cable length	≤ 60 m ¹⁾
	Permitted cross-section	≥ 1 mm ²
Configuration method		Hard wired
Display elements		LEDs 7-segment display
Fieldbus, industrial network	Integration via Flexi Soft safety controller	CANopen, DeviceNet™, EtherCAT®, EtherNet/IP™, Modbus TCP, PROFIBUS DP, PROFINET ²⁾

¹⁾ Depending on load, power supply and wire cross-section. The technical specifications must be observed.

²⁾ For additional information on Flexi Soft -> www.sick.com/Flexi_Soft.

Electrical data

	Sender	Receiver
Protection class	III (EN 50178)	
Supply voltage V_S	24 V DC (19.2 V DC ... 28.8 V DC) ¹⁾	
Power consumption	≤ 3.7 W (DC)	≤ 5 W (DC)
Safety outputs (OSSD)	Type of output	2 PNP semiconductors, short-circuit protected, cross-circuit monitored ²⁾
	Switching voltage HIGH	24 V DC ($V_S - 2.25$ V DC ... V_S)
	Switching voltage LOW	≤ 1 V DC
	Switching current	≤ 500 mA

¹⁾ The external voltage supply must be capable of buffering brief mains voltage failures of 20 ms as specified in EN 60204-1. Suitable power supplies are available as accessories from SICK.

²⁾ Applies to the voltage range between -30 V and +30 V.

Mechanical data

Housing cross-section	48 mm x 40 mm
------------------------------	---------------

Ambient data

Enclosure rating	IP65 (EN 60529)
Ambient operating temperature	0 °C ... +55 °C
Storage temperature	-25 °C ... +70 °C
Air humidity	15 % ... 95 %, Non-condensing
Vibration resistance	5 g, 10 Hz ... 55 Hz (IEC 60068-2-6)
Shock resistance	10 g, 16 ms (IEC 60068-2-29)

Other information

Wave length	950 nm
--------------------	--------

Dimensional drawing (Dimensions in mm (inch))

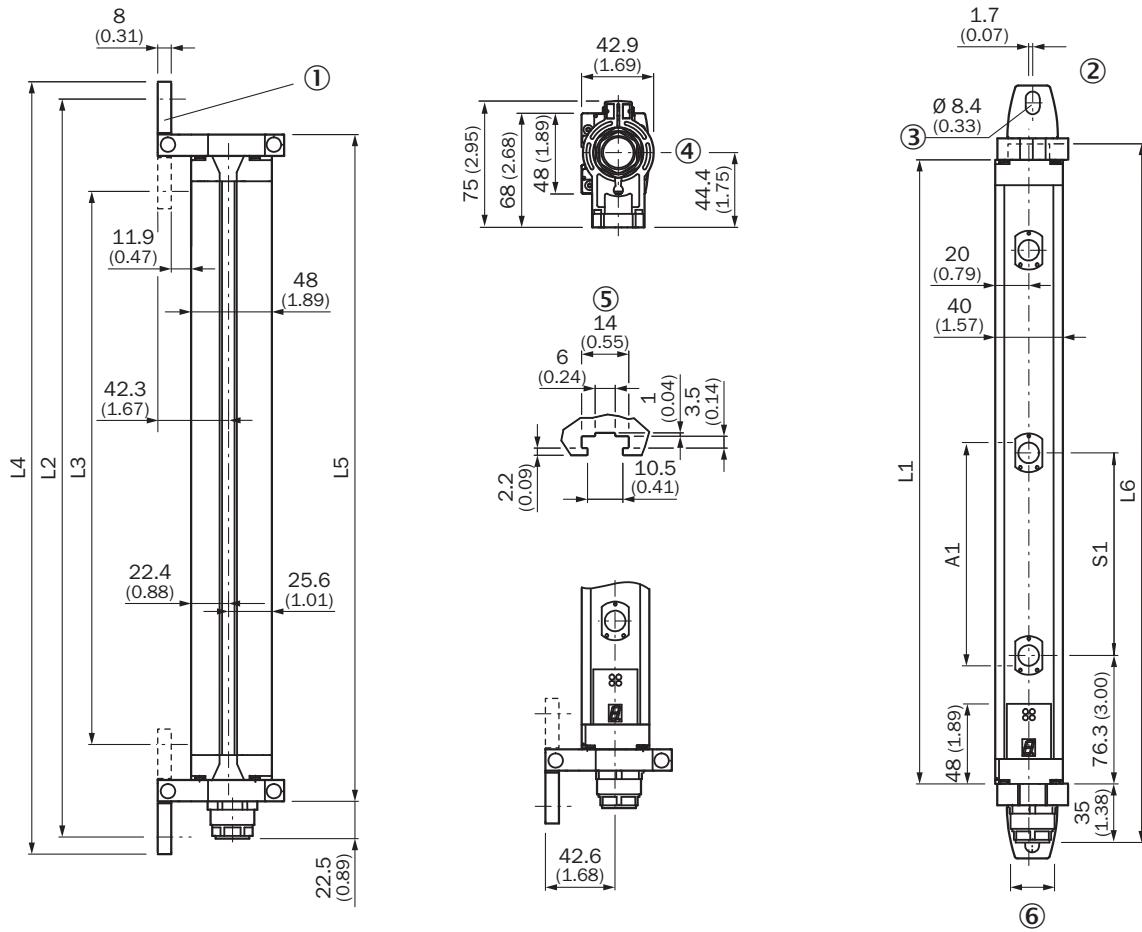

Number of beams	Beam separation	Resolution	L1	L2	L3	L4	L5	L6
2	500 (19.69)	-	630 (24.80)	697 (27.44)	588 (23.15)	718 (28.27)	655 (25.79)	675 (26.57)
3	400 (15.75)	-	931 (36.65)	998 (39.29)	888 (34.96)	1,019 (40.12)	956 (37.64)	976 (38.43)
4	300 (11.81)	-	1,031 (40.59)	1,098 (43.23)	989 (38.94)	1,119 (44.06)	1,056 (41.57)	1,076 (42.36)
6	-	170 (6.69)	916 (36.06)	983 (38.70)	874 (34.41)	1,004 (39.53)	941 (37.05)	960 (37.80)
7	-	170 (6.69)	1,073 (42.24)	1,140 (44.88)	1,031 (40.59)	1,161 (45.71)	1,098 (43.23)	1,118 (44.02)
8	-	116 (4.57)	851 (33.50)	919 (36.18)	809 (31.85)	939 (36.97)	877 (34.53)	896 (35.28)
8	-	170 (6.69)	1,231 (48.46)	1,298 (51.10)	1,189 (46.81)	1,319 (51.93)	1,256 (49.45)	1,275 (50.20)
9	-	170 (6.69)	1,388 (54.65)	1,455 (57.28)	1,346 (52.99)	1,476 (58.11)	1,413 (55.63)	1,433 (56.42)

Connection diagram

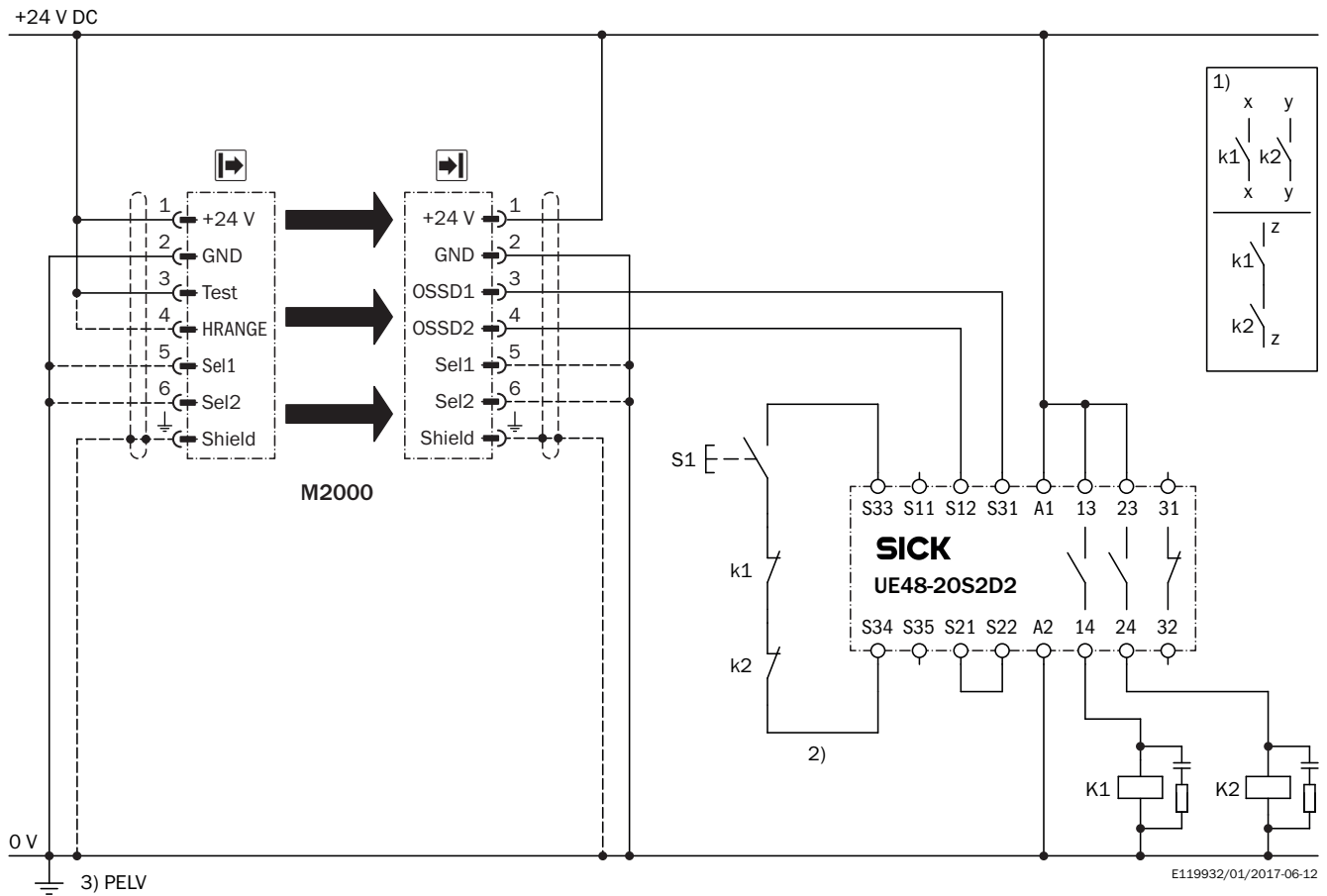

Task

Connection of an M2000 Standard multi-beam photoelectric safety switch to UE48-20S.

Operating mode: with restart interlock and external device monitoring.

Function

When the light path is clear, the OSSD1 and OSSD2 outputs are live. The system is ready to switch on if K1 and K2 are de-energized. By pressing S1 (button is pressed and released), the UE48-20S is energized and its 13 - 14 and 23 - 24 contacts activate K1 and K2. On interruption of one of the light beams, the UE48-20S is de-energized by the OSSD1 and OSSD2 outputs and K1 and K2 are deactivated.

Fault analysis

OSSD cross-circuits and short-circuits are detected and lead to the inhibited state (lock-out). The incorrect functioning of one of the K1 or K2 contactors will be detected and does not result in the loss of the shutdown function. Jamming of the S1 button will prevent the UE48-20S from enabling.

Comments

¹⁾ Output circuits: These contacts are to be connected to the controller such that, with the output circuit open, the dangerous state is disabled. For categories 4 and 3, the integration must be dual-channel (x/y paths). Single-channel integration in the control (z path) is only possible with a single-channel control and by taking the risk analysis into account.







²⁾ The external device monitoring is only static.

³⁾ PELV as required in EN 60204-1 / 6.4

The related operating instructions for the integrated devices must be observed.

Recommended accessories

Other models and accessories → www.sick.com/M2000_Standard

	Brief description	Type	Part no.
Mounting brackets and plates			
	4 pieces, Mounting kit 1, mounting bracket, rigid, L-shaped, including fixing screws and washers	BEF-3WNGBAST4	7021352
Terminal and alignment brackets			
	4 pieces, Mounting kit 6, side bracket, rotatable, Zinc diecast	BEF-1SHABAZN4	2019506
	4 pieces, Omega bracket, rotatable, fixable with only one screw, for mounting on the swivel mount	BEF-2SMMEAAL4	2044847
	4 pieces, Mounting kit 2, rotatable, swivel mount, Polyamide PA6	BEF-2SMMEAUK4	2019659
Alignment aids			
	Laser alignment aid for various sensors, laser class 2 (IEC 60825). Do not look into the beam!	AR60	1015741
	Adapter AR60 for housing cross-section 48 mm x 40 mm	AR60 adapter, 48x40	4032461
	Adapter AR60 for housing cross-section 48 mm x 40 mm in PU3H device column	AR60 adapter, 48x40, PU3H	4056731

SICK AT A GLANCE

SICK is one of the leading manufacturers of intelligent sensors and sensor solutions for industrial applications. A unique range of products and services creates the perfect basis for controlling processes securely and efficiently, protecting individuals from accidents and preventing damage to the environment.

We have extensive experience in a wide range of industries and understand their processes and requirements. With intelligent sensors, we can deliver exactly what our customers need. In application centers in Europe, Asia and North America, system solutions are tested and optimized in accordance with customer specifications. All this makes us a reliable supplier and development partner.

Comprehensive services complete our offering: SICK LifeTime Services provide support throughout the machine life cycle and ensure safety and productivity.

For us, that is “Sensor Intelligence.”

WORLDWIDE PRESENCE:

Contacts and other locations –www.sick.com