

Type AEB

SMT Aluminum Electrolytic Capacitors - High Voltage, 105 °C

Low Impedance and Long Life for High Voltage, High Ripple Current Applications



Type AEB capacitors are it for high voltage applications like input bus capacitors in board mounted miniature AC/DC supplies. The AEB's low impedance in ratings up to 450 Vdc, and long life, make it ideal for power supply input and other high voltage applications. The vertical, cylindrical cases make easy automatic mounting and reflow soldering.

Highlights

+105 °C, Up to 5000 Hour Load Life
 Capacitance Range: 2.2 μF to 100 μF
 Voltage Range: 160 Vdc to 450 Vdc

Specifications

Operating Temperature: -20 °C to +105 °C
Rated Voltage: 160, 200, 250, 350, 400, 450 Vdc
Capacitance: 2.2 μF to 100 μF
Capacitance Tolerance: ±20% @ 120 Hz and +20 °C

Life Test: 5000 h @ +105 °C, L — S Cases
 4000 h @ +105 °C, K Case
 3000 h @ +105 °C, J Case
 Δ Capacitance ± 20%
 DF: ≤ 200% of limit
 DCL: ≤ 100% of limit

Shelf Test: 1000 h @ 105 °C
 Δ Capacitance ± 20%
 DF: ≤ 200% of limit
 DCL: ≤ 100% of limit

AEB Series Marking

Outline Drawing

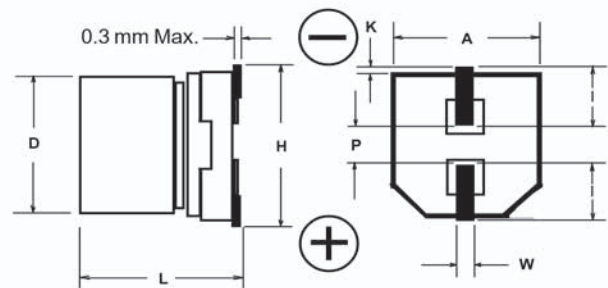
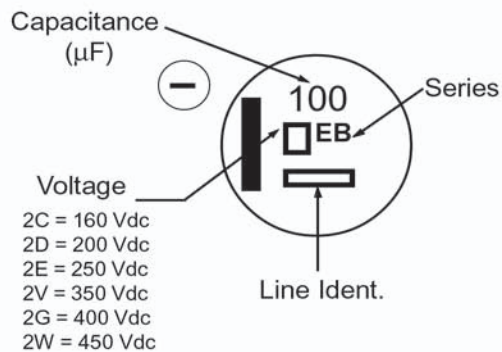

Case Dimensions

Case Code	D ±0.5	L ±0.5	A ±0.2	H (max)	I (ref)	W	P (ref)	K (mm)
J	10.0	13.5	10.3	12	3.5	0.9 ±0.2	4.6	0.7 ± 0.2
K	10.0	16.5	10.3	12	3.5	0.9 ±0.2	4.6	0.7 ± 0.2
L	12.5	16.5	13.5	15	4.7	0.9 ±0.3	4.4	0.7 ± 0.3
P	16.0	16.5	17.0	19	6.7	1.2 ±0.3	6.7	0.7 ± 0.3
U	16.0	21.5	17.0	19	6.7	1.2 ±0.3	6.7	0.7 ± 0.3
R	18.0	16.5	19.0	21	6.7	1.2 ±0.3	6.7	0.7 ± 0.3
S	18.0	21.5	19.0	21	6.7	1.2 ±0.3	6.7	0.7 ± 0.3

Type AEB

SMT Aluminum Electrolytic Capacitors - High Voltage, 105 °C

Ratings

RoHS Compliant

Cap (μ F)	Catalog Part Number	Max. DCL 2 min (μ A)	Max. Dissipation Factor @ 120 Hz 20 °C	Max. Impedance @ 100 20 °C (Ω)	Max. Ripple Current @ 105 °C 100 kHz (mA)	Size (mm) D x L	Quantity Reel
160 Vdc							
10.0	AEB106M2CJ32T-F	106	0.15	3.00	70	10 x 13.5	250
33.0	AEB336M2CL32T-F	327	0.15	1.80	470	12.5 x 16.5	150
47.0	AEB476M2CP44T-F	461	0.15	1.40	600	16 x 16.5	125
68.0	AEB686M2CU44T-F	663	0.15	0.55	750	16 x 21.5	75
68.0	AEB686M2CR44T-F	663	0.15	0.80	750	18 x 16.5	125
100.0	AEB107M2CS44T-F	970	0.15	0.50	1060	18 x 21.5	75
200 Vdc							
22.0	AEB226M2DL32T-F	274	0.15	1.80	470	12.5 x 16.5	150
33.0	AEB336M2DP44T-F	406	0.15	1.40	600	16 x 16.5	125
47.0	AEB476M2DR44T-F	574	0.15	0.80	600	18 x 16.5	125
68.0	AEB686M2DU44T-F	826	0.15	0.55	750	16 x 21.5	75
100.0	AEB107M2DS44T-F	1210	0.15	0.50	1060	18 x 21.5	75
250 Vdc							
10.0	AEB106M2EK32T-F	160	0.15	2.50	88	10 x 16.5	200
22.0	AEB226M2EP44T-F	340	0.15	1.60	560	16 x 16.5	125
33.0	AEB336M2ER44T-F	505	0.15	0.85	560	18 x 16.5	125
47.0	AEB476M2EU44T-F	715	0.15	0.70	710	16 x 21.5	75
68.0	AEB686M2ES44T-F	1030	0.15	0.60	990	18 x 21.5	75
350 Vdc							
10.0	AEB106M2VP44T-F	220	0.20	3.20	270	16 x 16.5	125
22.0	AEB226M2VR44T-F	472	0.20	1.60	350	18 x 16.5	125
33.0	AEB336M2VU44T-F	703	0.20	1.20	480	16 x 21.5	75
47.0	AEB476M2VS44T-F	997	0.20	1.00	670	18 x 21.5	75
400 Vdc							
3.3	AEB335M2GJ32T-F	89	0.24	8.00	40	10 x 13.5	250
4.7	AEB475M2GK32T-F	123	0.24	5.50	50	10 x 16.5	200
10.0	AEB106M2GP44T-F	250	0.24	3.60	250	16 x 16.5	125
22.0	AEB226M2GU44T-F	538	0.24	2.20	410	16 x 21.5	75
33.0	AEB336M2GS44T-F	802	0.24	1.20	600	18 x 21.5	75
450 Vdc							
2.2	AEB225M2WJ32T-F	69	0.24	11.00	29	10 x 13.5	250
3.3	AEB335M2WK32T-F	99	0.24	7.00	41	10 x 16.5	200
4.7	AEB475M2WL32T-F	137	0.24	4.80	49	12.5 x 16.5	150
10.0	AEB106M2WR44T-F	280	0.24	3.00	310	18 x 16.5	125
22.0	AEB226M2WS44T-F	604	0.24	1.80	560	18 x 21.5	75

Part Numbering System

AEB	106	M	2C	J	32T	-F
Type	Capacitance	Capacitance Tolerance	Voltage Code	Case Code	Packaging Information	RoHS Compliant
	105 = 1.0 μ F 106 = 10.0 μ F 107 = 100.0 μ F	M = \pm 20%	2C = 160 Vdc 2D = 200 Vdc 2E = 250 Vdc	2V = 350 Vdc 2G = 400 Vdc 2W = 450 Vdc	32 = Carrier tape Width (mm) T = Tape & Reel B = bulk	

Type AEB

SMT Aluminum Electrolytic Capacitors - High Voltage, 105 °C

Typical Performance Curves

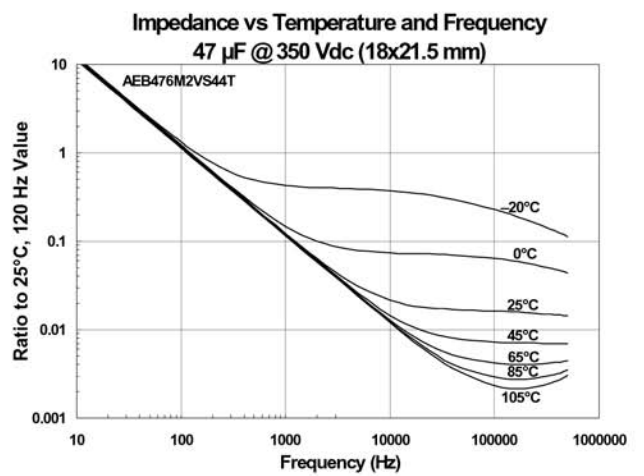
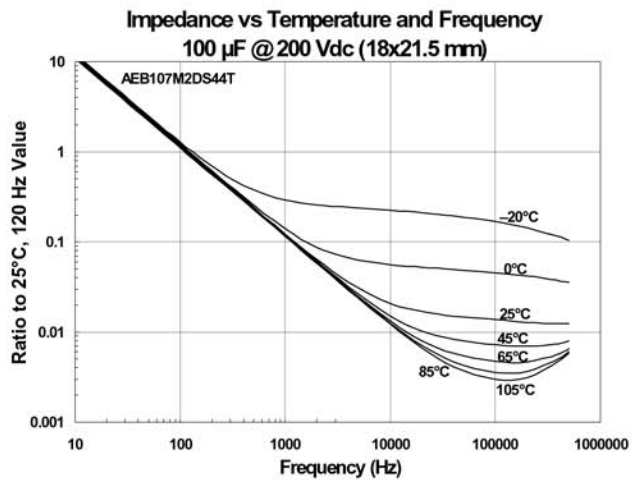
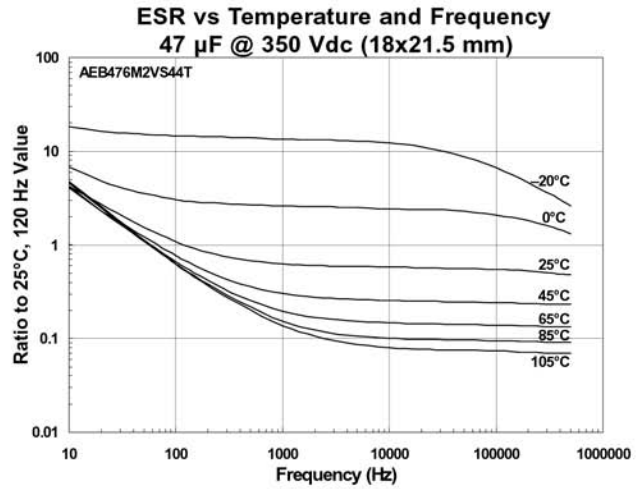
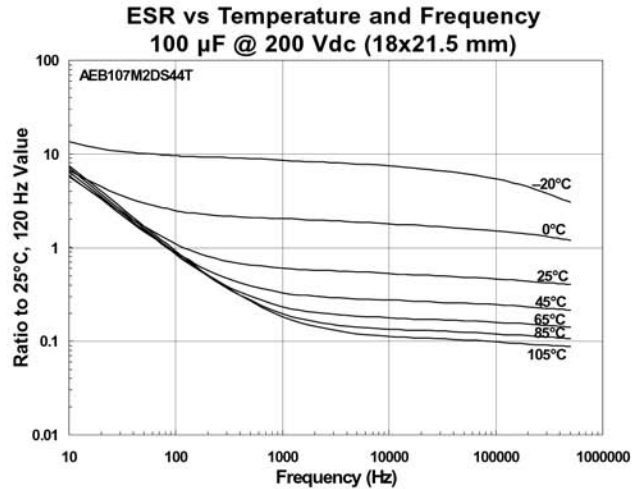
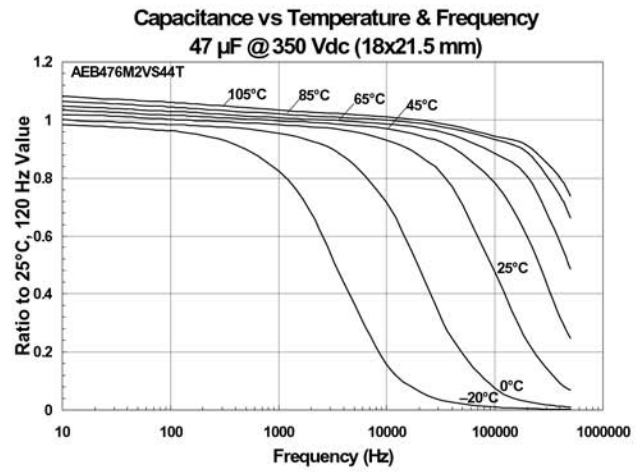
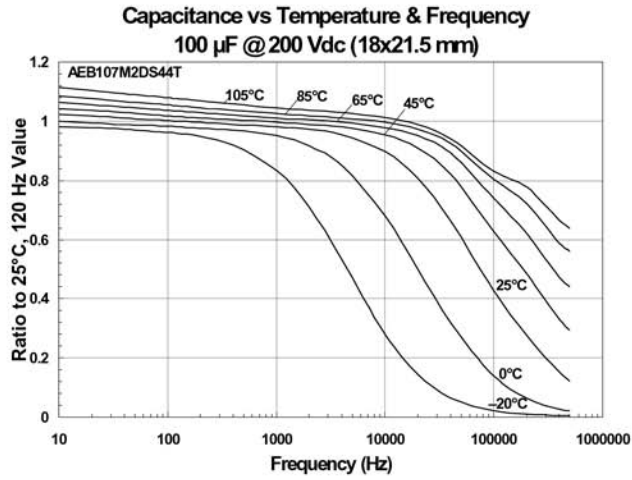

Type AEB

SMT Aluminum Electrolytic Capacitors - High Voltage, 105 °C

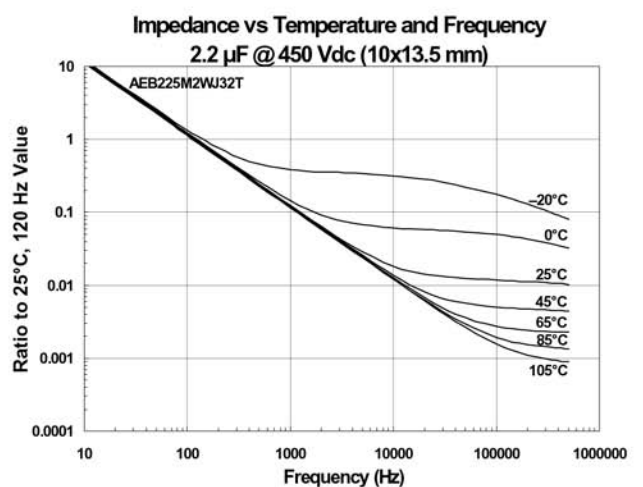
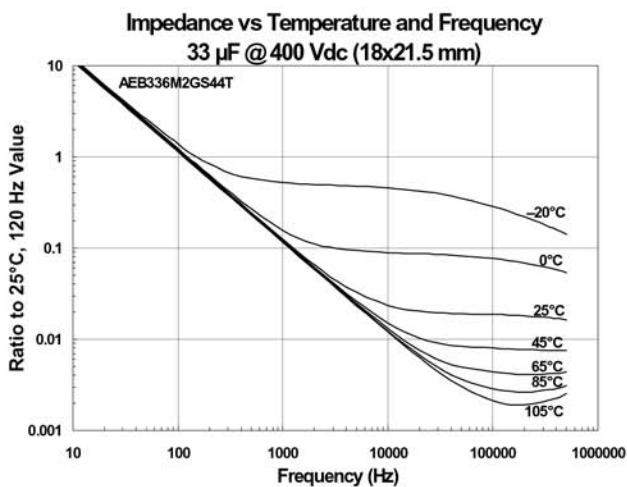
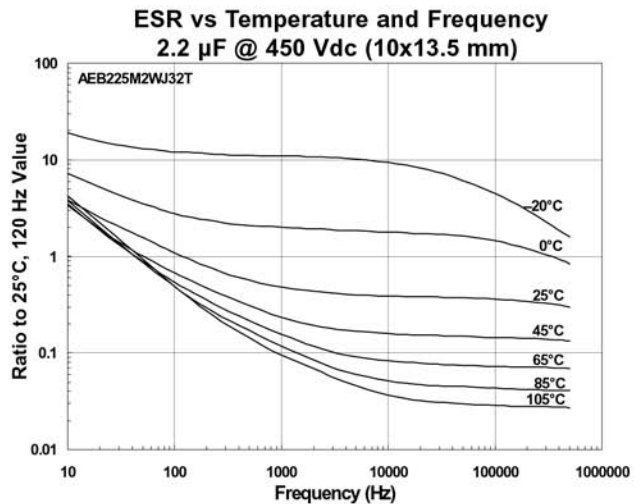
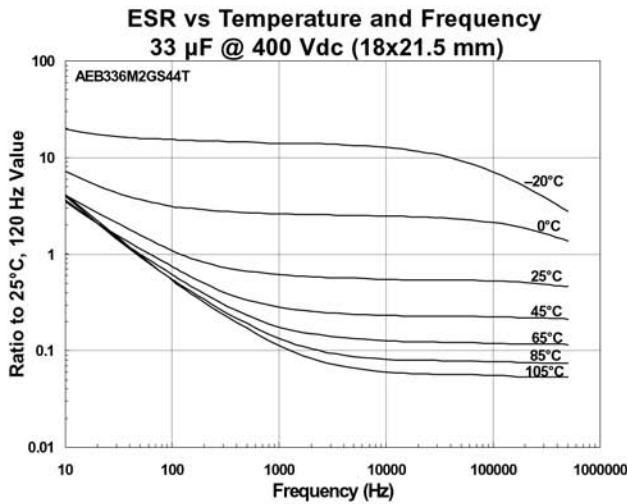
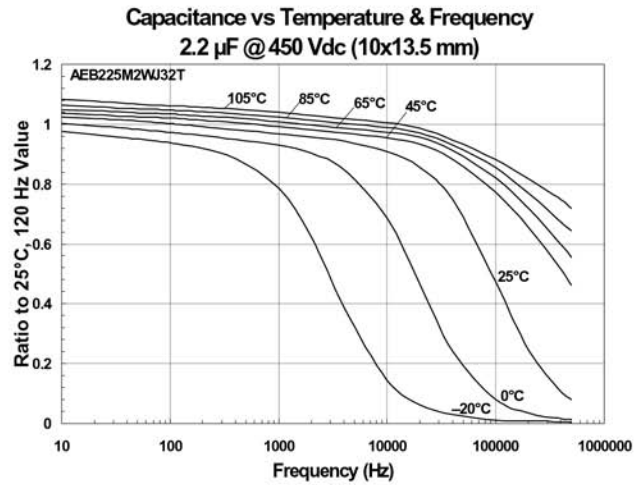
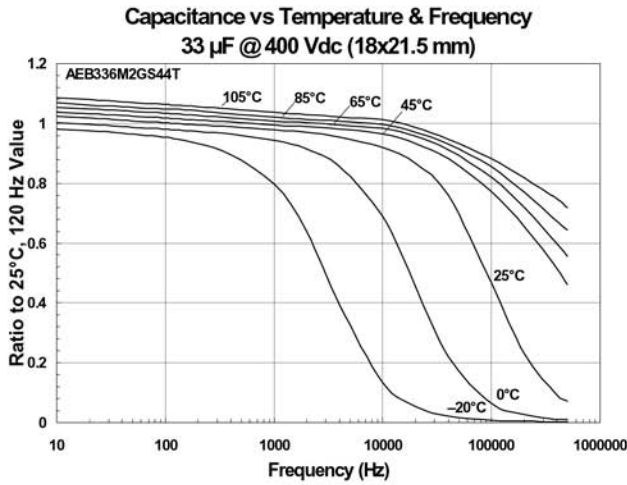

Type AEB

SMT Aluminum Electrolytic Capacitors - High Voltage, 105 °C

