

**Ovel Type LED lamp**
**BL-L557**
**Features:**

- 5mm Ovel Type (5.0\*4.1\*7.1mm) LED Lamps
- Ultra brightness.
- Choice of various viewing angles.
- Diffused, Transparent and Water clear lens
- IC compatible /Low current capability.
- RoHs Compliance

**Electrical-optical characteristics: (Ta=25°C) (Test Condition: IF=20mA)**

| Part Number | Chip               |            |                     | Lens Type | Forward Voltage(VF)<br>Unit:V |        | Luminous Intensity (Iv)<br>Unit:mcd |      | Viewing Angle<br>2θ1/2 (deg) |
|-------------|--------------------|------------|---------------------|-----------|-------------------------------|--------|-------------------------------------|------|------------------------------|
|             | Emitted Color      | Material   | λ <sub>p</sub> (nm) |           | Typ                           | Max    | Min.                                | Typ. |                              |
|             |                    |            |                     |           | BL-L557SRC                    | Hi Red | AlGaAs,SH                           | 660  |                              |
| BL-L557LRC  | Super Red          | AlGaAs,DH  | 660                 | 1.85      | 2.20                          | 200    | 600                                 |      |                              |
| BL-L557URC  | Ultra Red          | AlGaAs,DDH | 660                 | 1.95      | 2.20                          | 500    | 750                                 |      |                              |
| BL-L557UEC  | Ultra Orange       | AlGaInP    | 630                 | 2.10      | 2.50                          | 250    | 800                                 |      |                              |
| BL-L557UYC  | Ultra Yellow       | AlGaInP    | 590                 | 2.10      | 2.50                          | 250    | 800                                 |      |                              |
| BL-L557UGC  | Ultra Green        | AlGaInP    | 574                 | 2.20      | 2.50                          | 100    | 250                                 |      |                              |
| BL-L557PGC  | Ultra Pure Green   | InGaN      | 525                 | 3.80      | 4.50                          | 600    | 1800                                |      |                              |
| BL-L557BGC  | Ultra Bluish Green | InGaN      | 505                 | 3.80      | 4.50                          | 550    | 1500                                |      |                              |
| BL-L557BC   | Blue               | InGaN      | 430                 | 3.80      | 4.50                          | 300    | 800                                 |      |                              |
| BL-L557UBC  | Ultra Blue         | InGaN      | 470                 | 2.70      | 4.20                          | 600    | 1500                                |      |                              |
| BL-L557VC   | UV                 | InGaN      | 405                 | 3.80      | 4.50                          | 50     | 90                                  |      |                              |
| BL-L557UWC  | Ultra White        | InGaN      | /                   | 2.70      | 4.20                          | 1000   | 2300                                |      |                              |

**Absolute maximum ratings (Ta=25°C)**

| Parameter   | SR  | LR  | UR  | UE  | UY  | UG  | PG  | BG  | B   | UB  | UV  | W   | Unit |
|---|---|-----|-----|-----|-----|-----|-----|-----|-----|-----|-----|-----|------|
| Forward Current I <sub>F</sub>                            | 25  | 25  | 25  | 30  | 30  | 30  | 30  | 30  | 30  | 30  | 30  | 30  | mA   |
| Power Dissipation P <sub>d</sub>                          | 60  | 60  | 60  | 65  | 65  | 75  | 110 | 110 | 120 | 120 | 120 | 120 | mW   |
| Reverse Voltage V <sub>R</sub>                            | 5   | 5   | 5   | 5   | 5   | 5   | 5   | 5   | 5   | 5   | 5   | 5   | V    |
| Peak Forward Current I <sub>PF</sub><br>(Duty 1/10 @1KHZ) | 150   | 150 | 150 | 150 | 150 | 150 | 150 | 100 | 100 | 100 | 100 | 100 | mA   |
| Operation Temperature T <sub>OPR</sub>                    | -40 to +80  |     |     |     |     |     |     |     |     |     |     |     | °C   |
| Storage Temperature T <sub>STG</sub>                      | -40 to +85  |     |     |     |     |     |     |     |     |     |     |     | °C   |
| Lead Soldering Temperature<br>T <sub>SOL</sub>            | Max.260±5°C for 3 sec Max.<br>(1.6mm from the base of the epoxy bulb) |     |     |     |     |     |     |     |     |     |     |     | °C   |

Ovel Type LED lamp

BL-L557

■ Package configuration & Internal circuit diagram

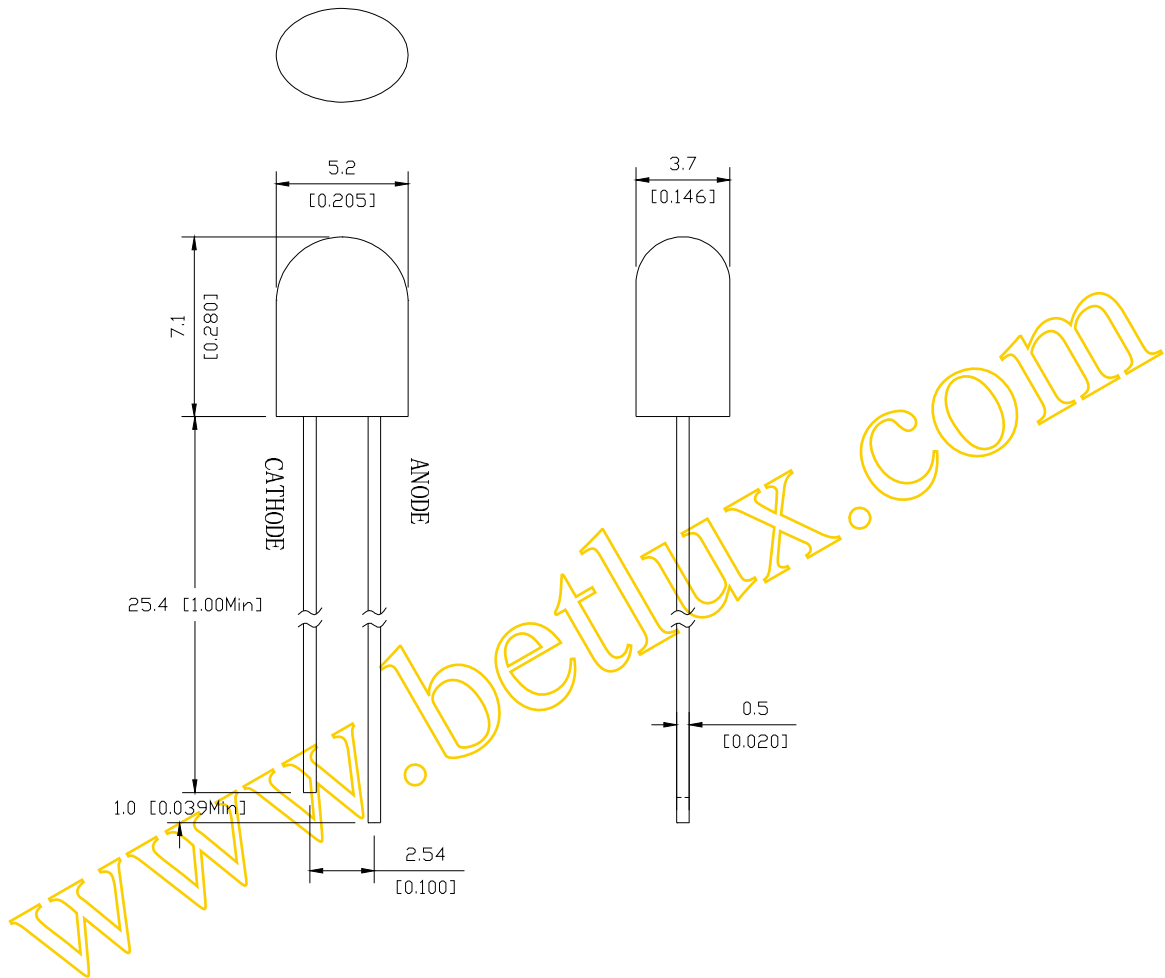

Notes:

1. All dimensions are in millimeters (inches)
2. Tolerance is  $\pm 0.25(0.01)$  unless otherwise noted.
3. Specifications are subject to change without notice.

Ovel Type LED lamp

BL-L557

Typical electrical-optical characteristics curves:

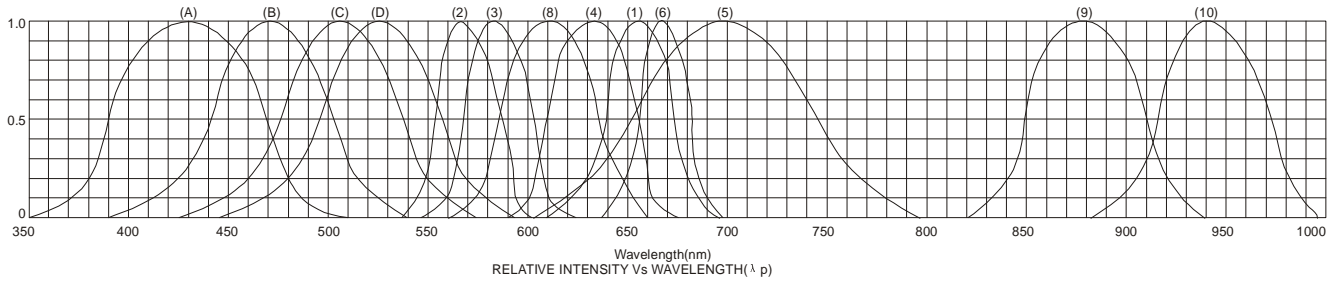

- (1) - GaAsP/GaAs 655nm/Red
- (2) - GaP 570nm/Yellow Green
- (3) - GaAsP/GaP 585nm/Yellow
- (4) - GaAsP/GaP 635nm/Orange & Hi-Eff Red
- (5) - GaP 700nm/Bright Red
- (6) - GaAlAs/GaAs 660nm/Super Red
- (8) - GaAsP/GaP 610nm/Super Red
- (9) - GaAlAs 880nm
- (10) - GaAs/GaAs & GaAlAs/GaAs 940nm
- (A) - GaN/SiC 430nm/Blue
- (B) - InGaN/SiC 470nm/Blue
- (C) - InGaN/SiC 505nm/Ultra Green
- (D) - InGaN/SiC 525nm/Ultra Green

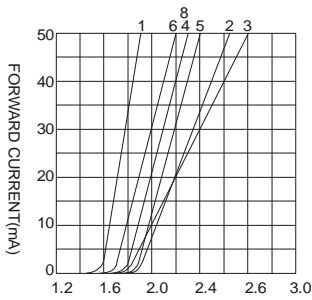

FORWARD VOLTAGE (Vf)  
FORWARD CURRENT VS.  
FORWARD VOLTAGE

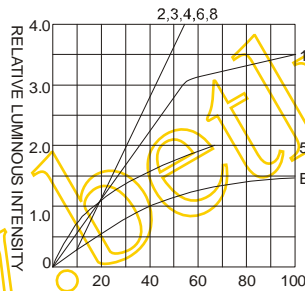

FORWARD CURRENT (mA)  
RELATIVE LUMINOUS  
INTENSITY VS. FORWARD  
CURRENT

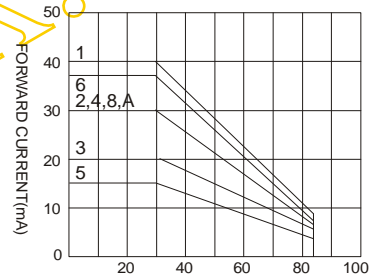

AMBIENT TEMPERATURE Ta(°C)  
FORWARD CURRENT VS. AMBIENT  
TEMPERATURE

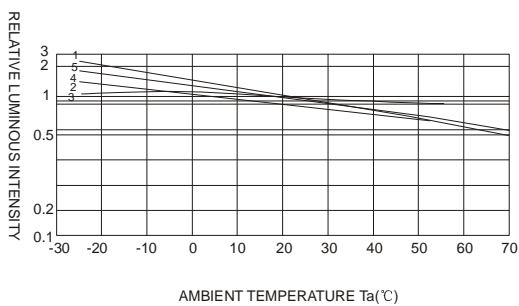

AMBIENT TEMPERATURE Ta(°C)

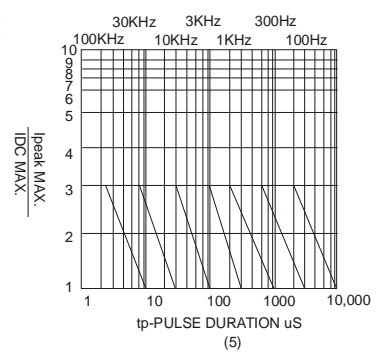
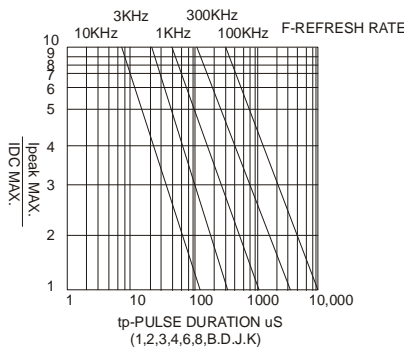

NOTE:25°C free air temperature unless otherwise specified