

Primax

Synonymous with function and performance, enter the Primax, the new era of high intensity illumination in LED. With its high flux output and high luminous intensity, Primax transcends today LED lightings technology and how we perceive it. The small package outline (3.7 x 3.5 x 0.8 mm) and high intensity make it an ideal choice for backlighting, signage, exterior automotive lighting and decorative lighting.



Features:

- > Super high brightness surface mount LED
- > 120° viewing angle.
- > Compact package outline (LxW) of 3.7 x 3.5 mm.
- > Ultra low height profile - 0.8mm.
- > Low thermal resistance.
- > Compatible to IR reflow soldering.
- > Corrosion resistance for automotive exterior applications.
- > Compliance to automotive standard; AEC-Q101.
- > Superior corrosion resistant.

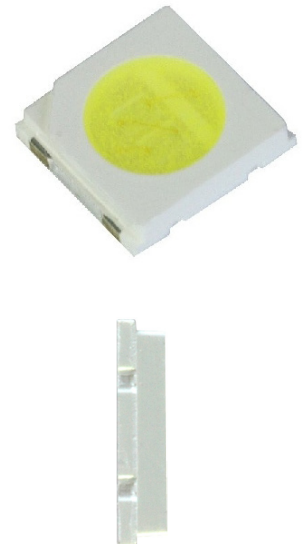

Applications:

- > Automotive: Exterior application: eg: DRL, Position Lamp, Signal Lighting, Fog lamp, Rear Combination Lights (RCLs), Reverse lamp.
- > Automotive: Interior application: eg: Dome Lamp, Trunk Lamp.

Optical Characteristics at Tj=25°C

Part Ordering Number	Color	Viewing Angle°	Luminous Flux @ 180mA (lm) <i>Appx. 1.2</i>		
			Min.	Typ.	Max.
MBWW-KZHG-UV3-L1P2	White	120	87.4	105.0	147.7

Electrical Characteristics at Tj=25°C

Part Number	Vf @ If = 180 mA <i>Appx. 3.1</i>		
	Min. (V)	Typ. (V)	Max. (V)
MBWW-KZHG	5.6	6.2	6.8

Absolute Maximum Ratings

	Maximum Value	Unit
DC forward current	250	mA
Peak pulse current (tp<=10µs , Duty cycle=0.10)	300	mA
Reverse voltage	Not designed for reverse bias	V
ESD threshold (HBM)	4000	V
LED junction temperature	150	°C
Operating temperature	-40 ... +125	°C
Storage temperature	-40 ... +125	°C
Thermal resistance		
- Real Thermal Resistance		
Junction / solder point, R _{th JS real} (typ = 13)	18	K/W
- Electrical Thermal Resistance		
Junction / solder point, R _{th JS el} (typ = 9)	12	K/W
(Mounting on DOMINANT standard PCB)		

MBWW-KZHG, Color Grouping *Appx. 2.1*

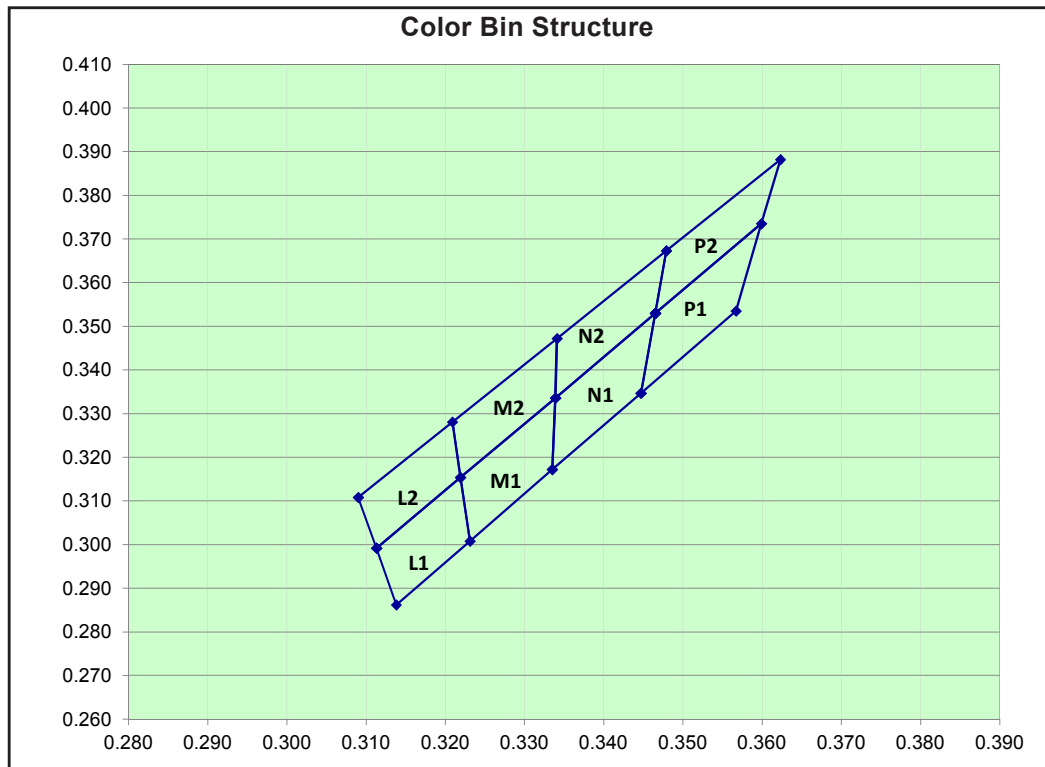

Bin		1	2	3	4
L1	Cx	0.3113	0.3138	0.3231	0.3219
	Cy	0.2992	0.2862	0.3008	0.3154
L2	Cx	0.3090	0.3113	0.3219	0.3209
	Cy	0.3108	0.2992	0.3154	0.3281
M1	Cx	0.3219	0.3231	0.3335	0.3339
	Cy	0.3154	0.3008	0.3172	0.3336
M2	Cx	0.3209	0.3219	0.3339	0.3341
	Cy	0.3281	0.3154	0.3336	0.3472
N1	Cx	0.3335	0.3339	0.3465	0.3447
	Cy	0.3172	0.3336	0.3530	0.3347
N2	Cx	0.3339	0.3341	0.3479	0.3465
	Cy	0.3336	0.3472	0.3673	0.3530
P1	Cx	0.3447	0.3465	0.3599	0.3567
	Cy	0.3347	0.3530	0.3735	0.3535
P2	Cx	0.3465	0.3479	0.3623	0.3599
	Cy	0.3530	0.3673	0.3882	0.3735

InGaN wavelength is very sensitive to drive current. Operating at lower current is not recommended and may yield unpredictable performance current pulsing should be used for dimming purposes.

Luminous Intensity Group at Tj=25°C

Brightness Group	Luminous Flux (lm) <i>Appx. 1.2</i>
U2	87.4 ... 99.4
U3	99.4 ... 113.6
V2	113.6 ... 129.2
V3	129.2 ... 147.7

Vf Binning (Optional)

Vf Bin @ 180mA	Forward Voltage (V) <i>Appx. 3.1</i>
V1	5.6 ... 5.8
V2	5.8 ... 6.0
V3	6.0 ... 6.2
V4	6.2 ... 6.4
V5	6.4 ... 6.6
V6	6.6 ... 6.8

Please consult sales and marketing for special part number to incorporate Vf binning.

Relative Luminous Flux Vs Forward Current

$\Phi_V/\Phi_V(180\text{mA}) = f(I_F); T_j = 25^\circ\text{C}$

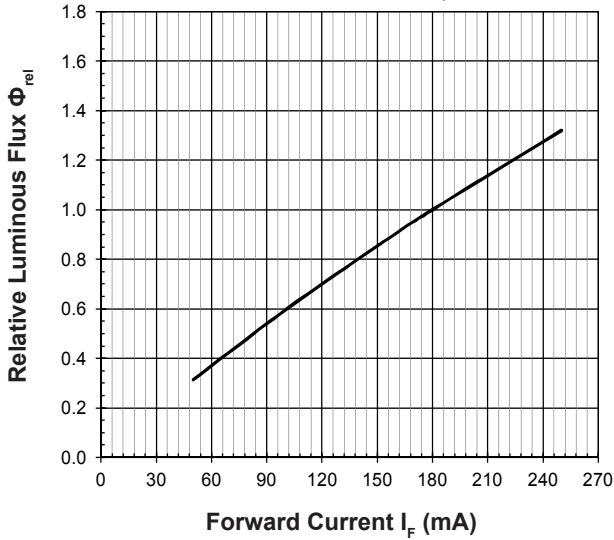

Forward Current Vs Forward Voltage

$I_F = f(V_F); T_j = 25^\circ\text{C}$

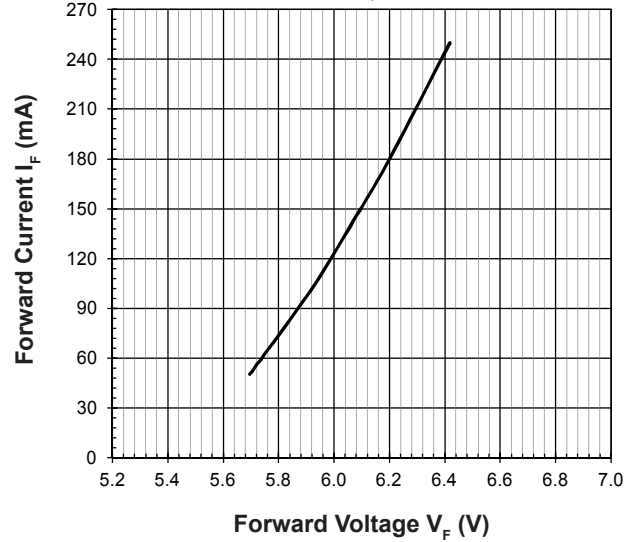

Maximum Current Vs Temperature

$I_F = f(T)$

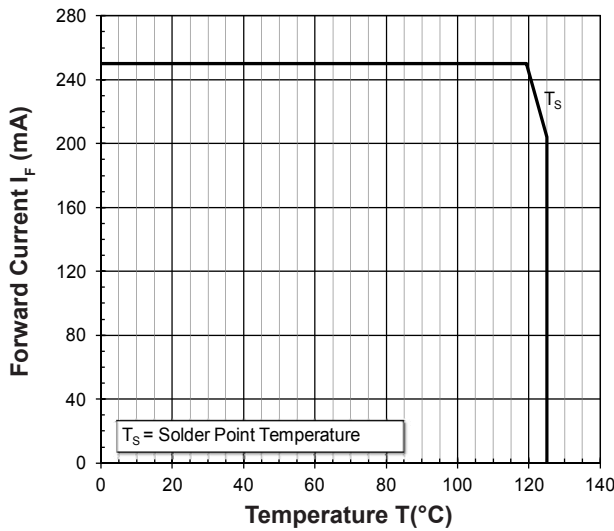

Relative Spectral Emission

$\Phi_{rel} = f(\lambda); T_j = 25^\circ\text{C}; I_F = 180\text{mA}$

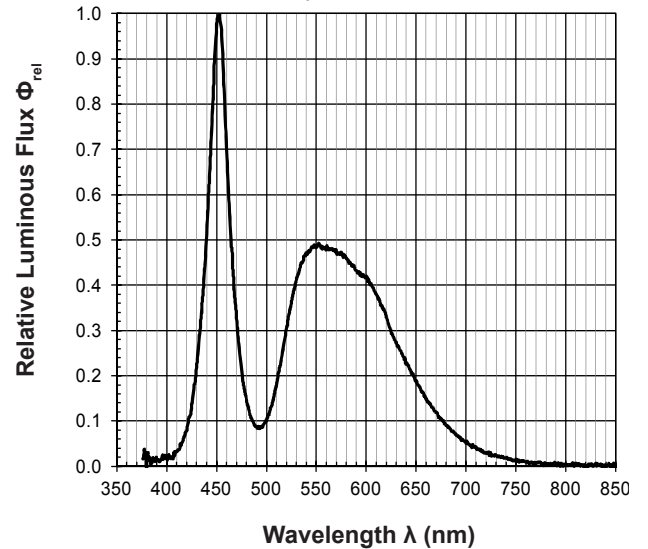

Chromaticity Coordinate Shift Vs Forward Current

$\Delta Cx, \Delta Cy = f(I_F); T_j = 25^\circ\text{C}$

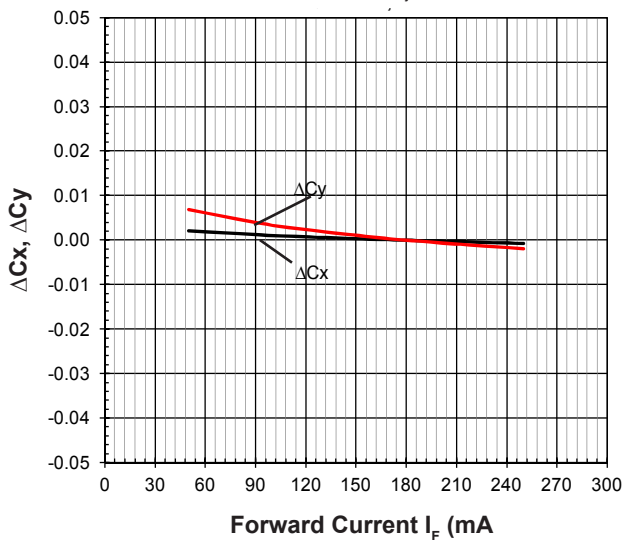

Allowable Forward Current Vs Duty Ratio

$(T_j = 25^\circ\text{C}; t_p \leq 10\mu\text{s})$

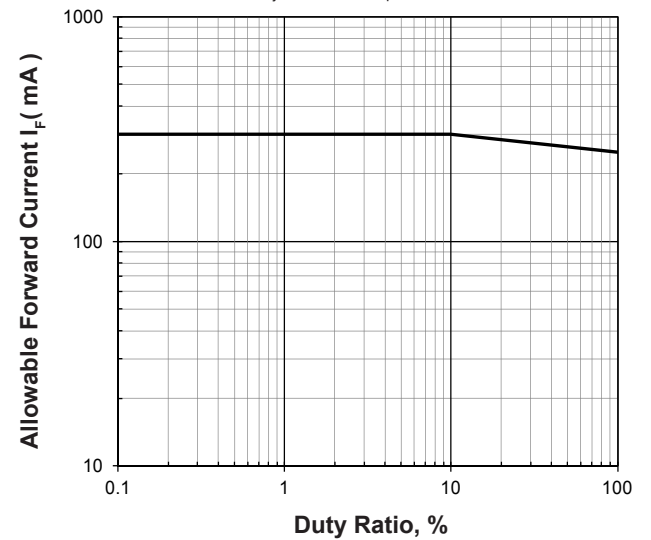

Radiation Pattern

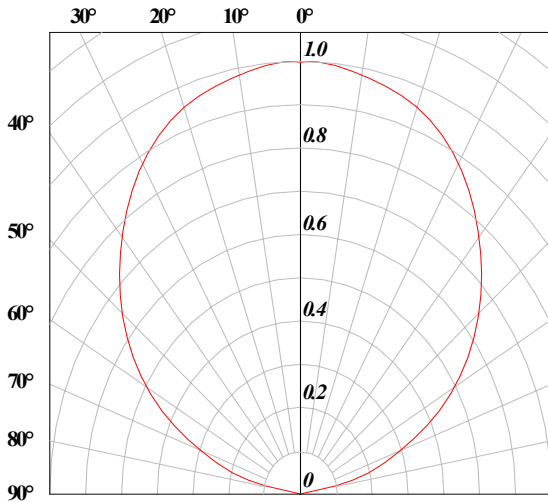

Relative Forward Voltage Vs Junction Temperature

$$\Delta V_F = V_F - V_F(25^\circ\text{C}) = f(T_j); I_F = 180\text{mA}$$

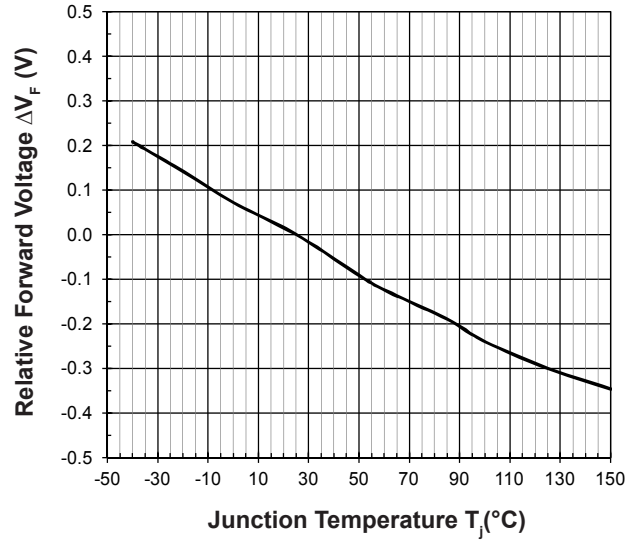

Relative Luminous Flux Vs Junction Temperature

$$\Phi_V/\Phi_V(25^\circ\text{C}) = f(T_j); I_F = 180\text{mA}$$

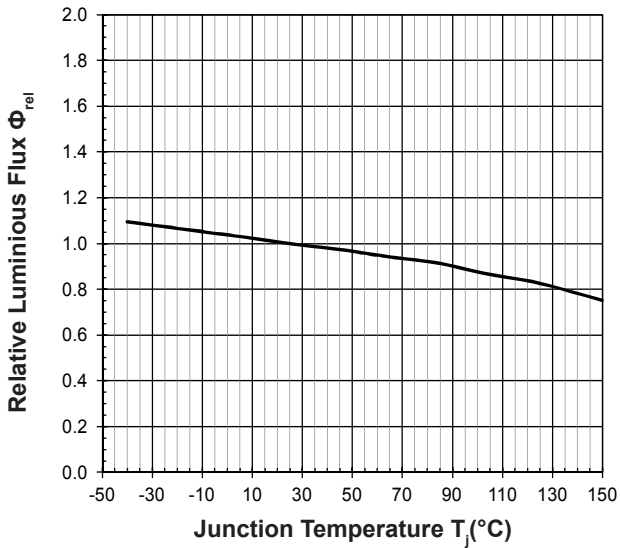

Chromaticity Coordinate Shift Vs Junction Temperature

$$\Delta C_x, \Delta C_y = f(T_j); I_F = 180\text{mA}$$

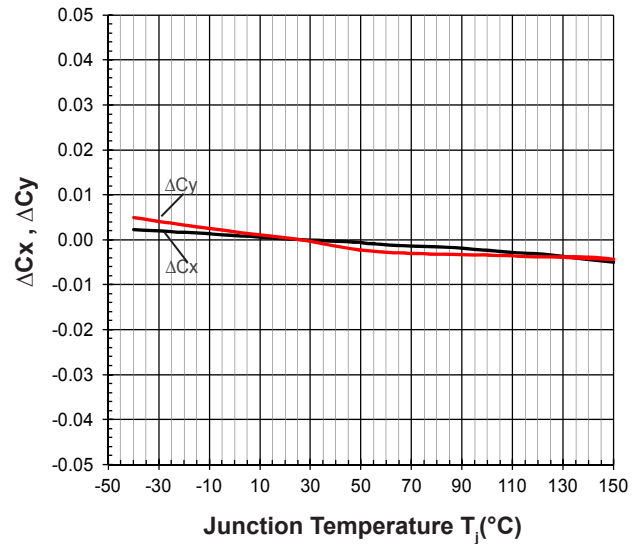

PrimaxPlus • 180 InGaN White: MBWW-KZHG-L1P2 Package Outlines

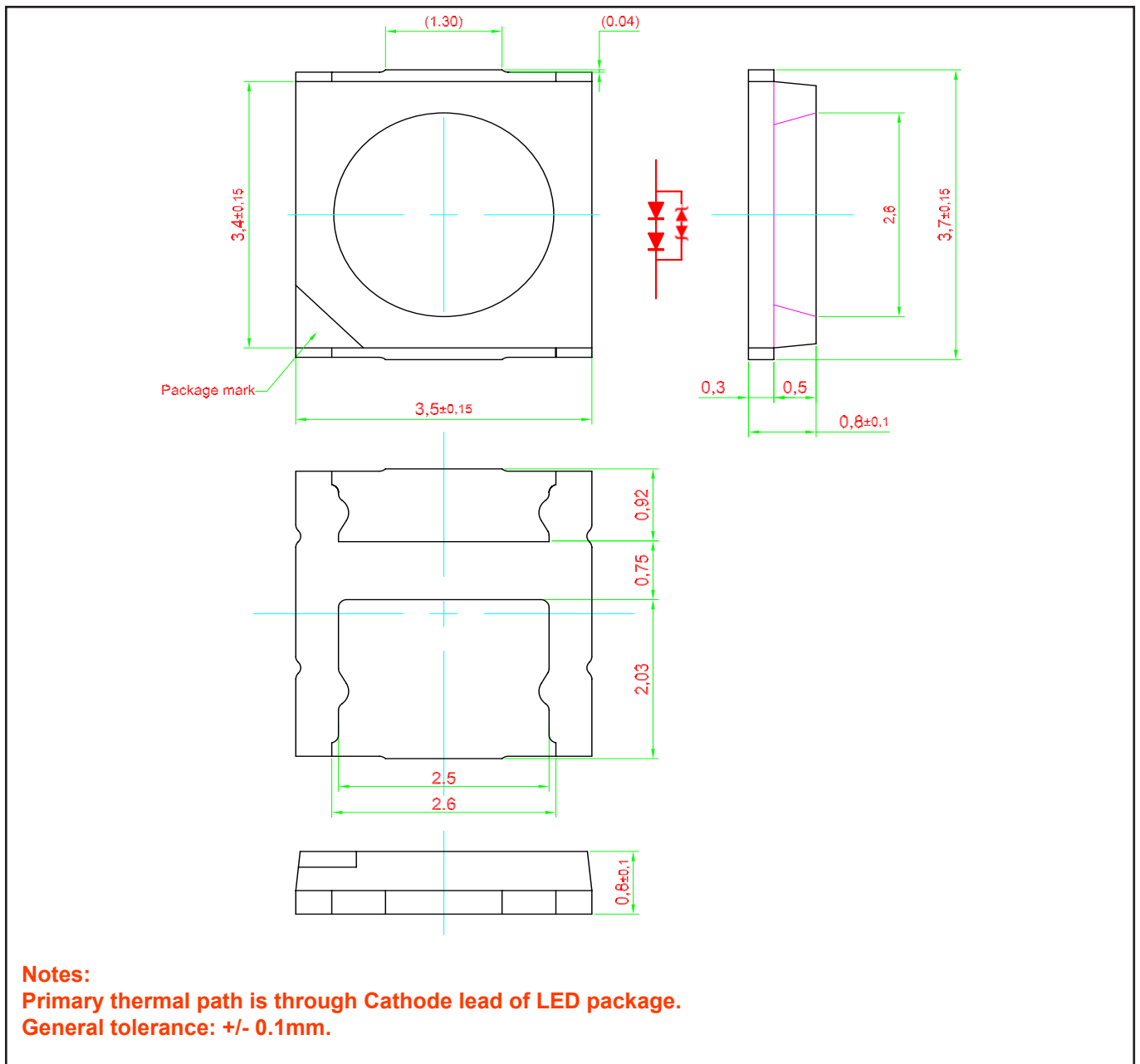

Material

Material	
Lead-frame	Cu Alloy With Au Plating
Package	High Temperature Resistant Plastic
Encapsulant	Silicone Resin
Soldering Leads	Au Plating

Note: This product is Pb free

Recommended Solder Pad

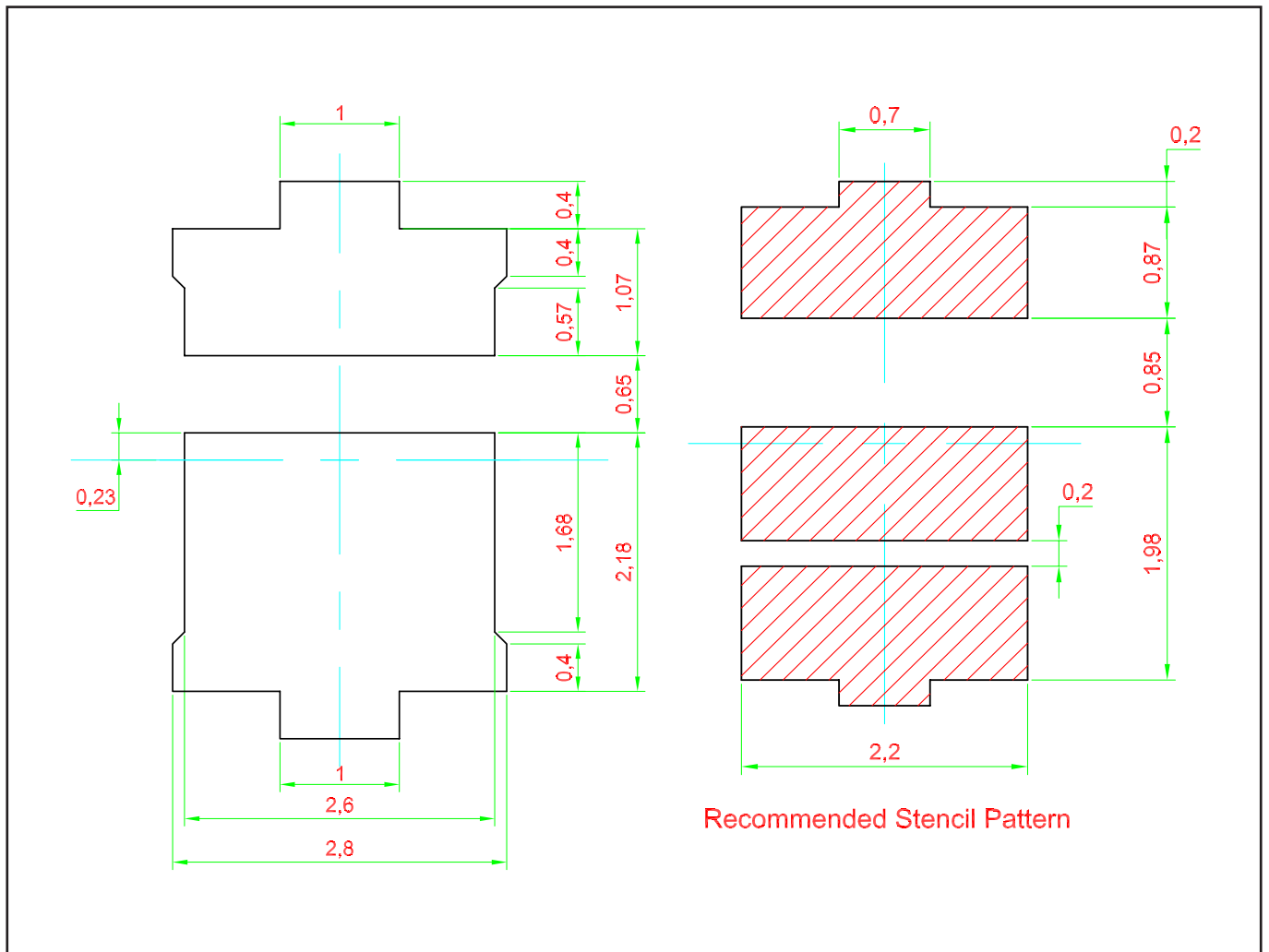

Taping and orientation

- Reels come in quantity of 1000 units.
- Reel diameter is 180 mm.

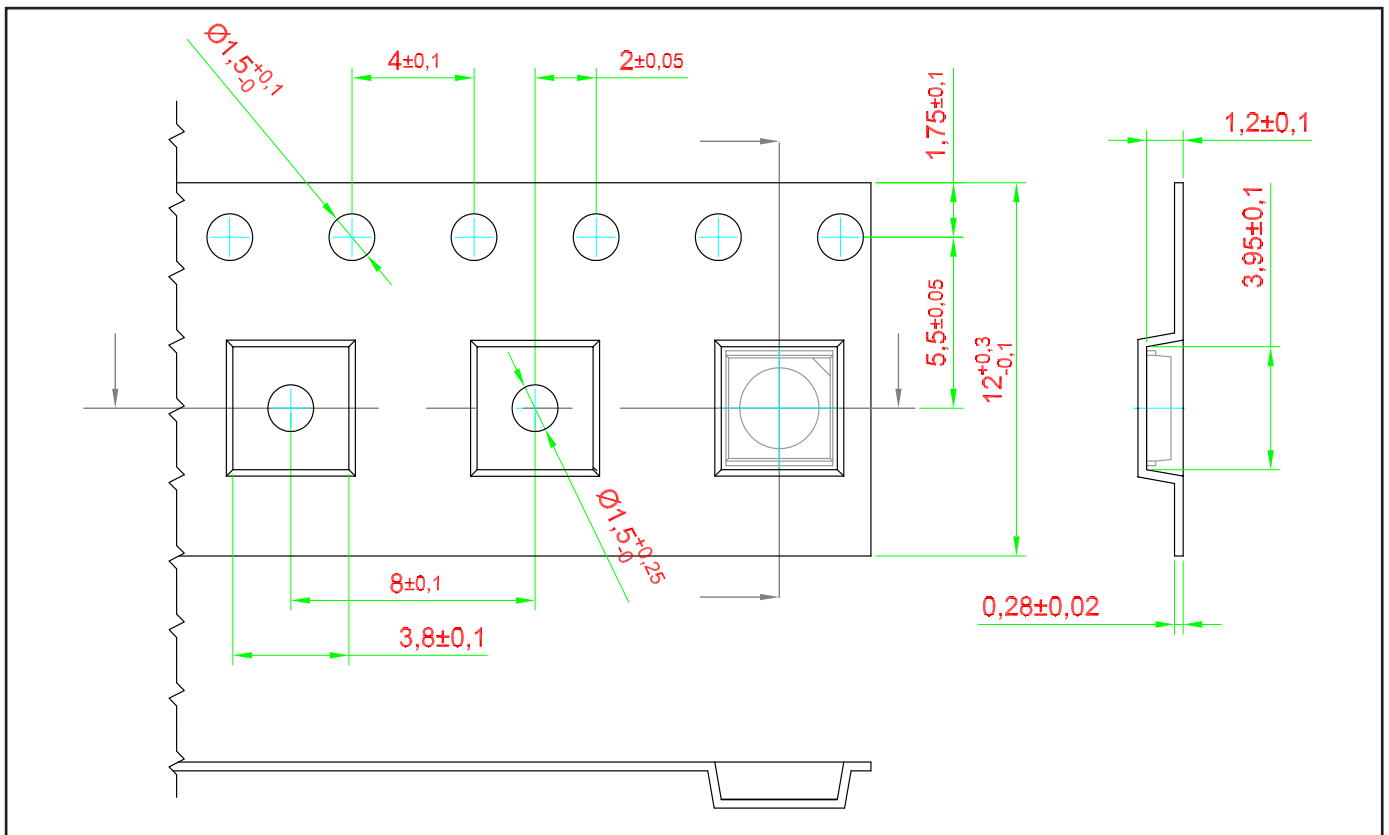

Packaging Specification

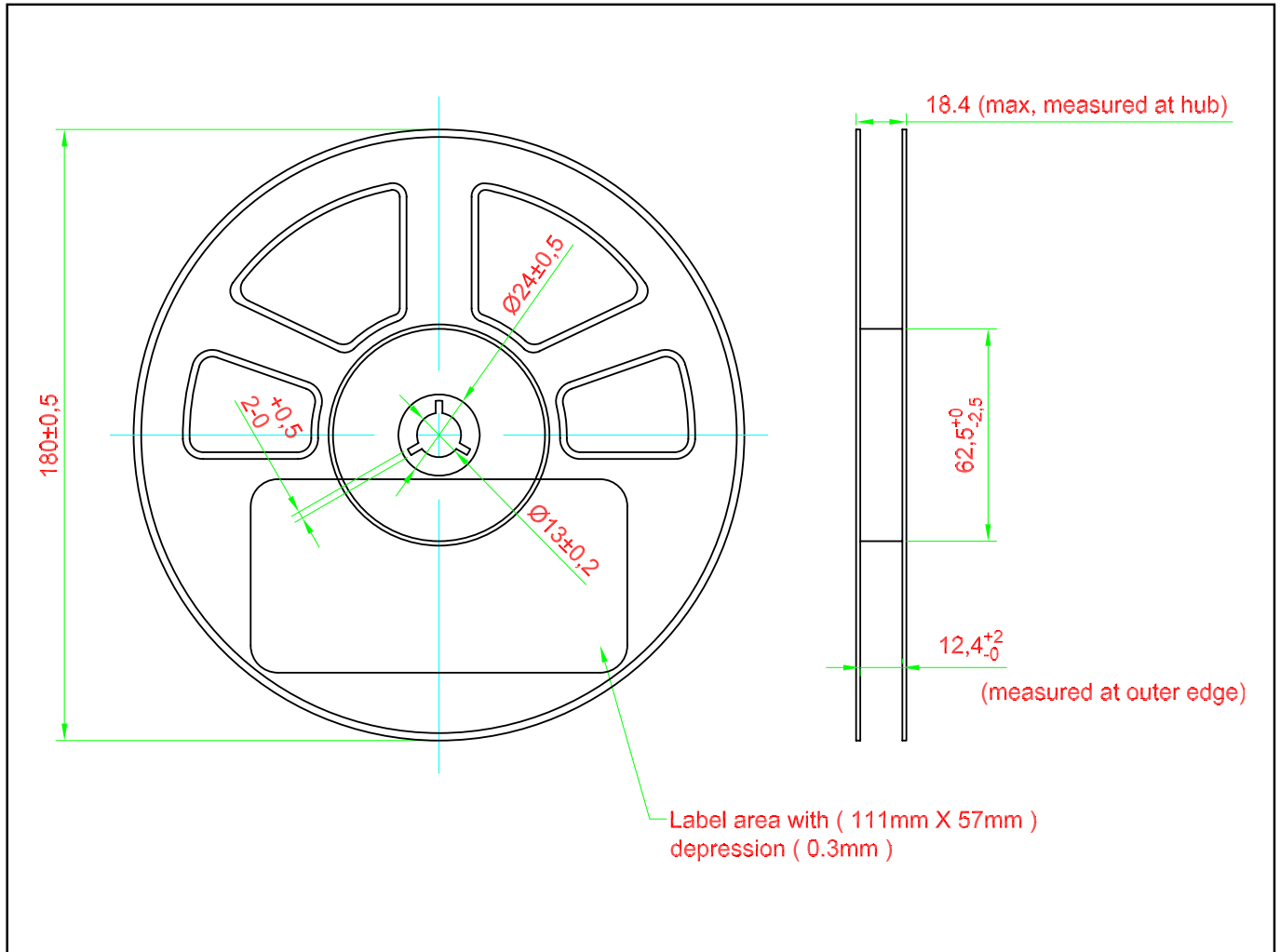

Packaging Specification

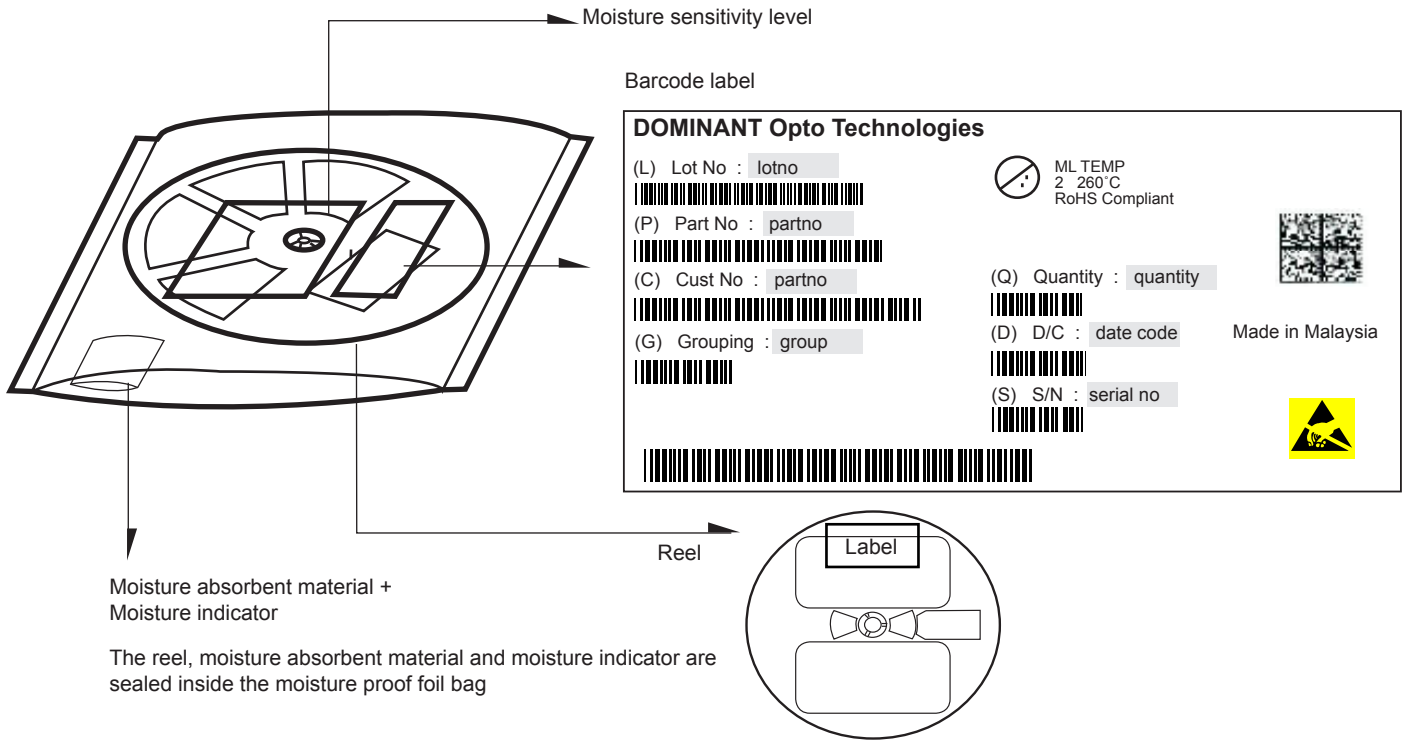

	Average 1pc PrimaxPlus	1 completed bag (1000pcs)
Weight (gram)	0.034	230 ± 10

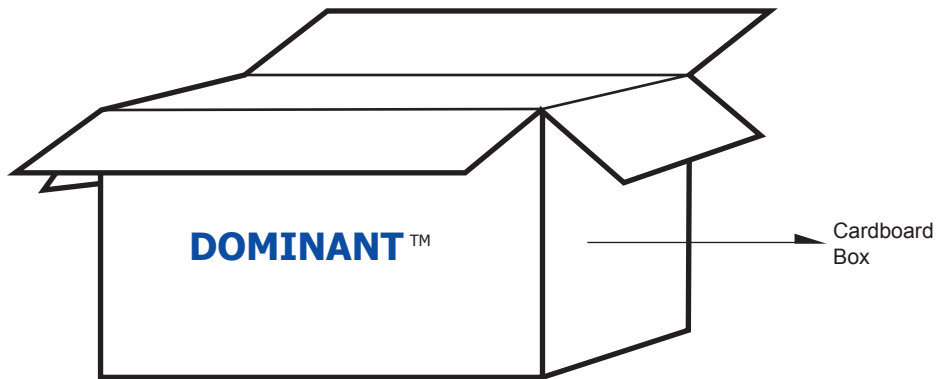

For PrimaxPlus

Cardboard Box Size	Dimensions (mm)	Empty Box Weight (kg)	Reel / Box
Super Small	325 x 225 x 190	0.38	7 reels MAX
Small	325 x 225 x 280	0.54	11 reels MAX
Medium	570 x 440 x 230	1.46	48 reels MAX
Large	570 x 440 x 460	1.92	96 reels MAX

Recommended Pb-free Soldering Profile

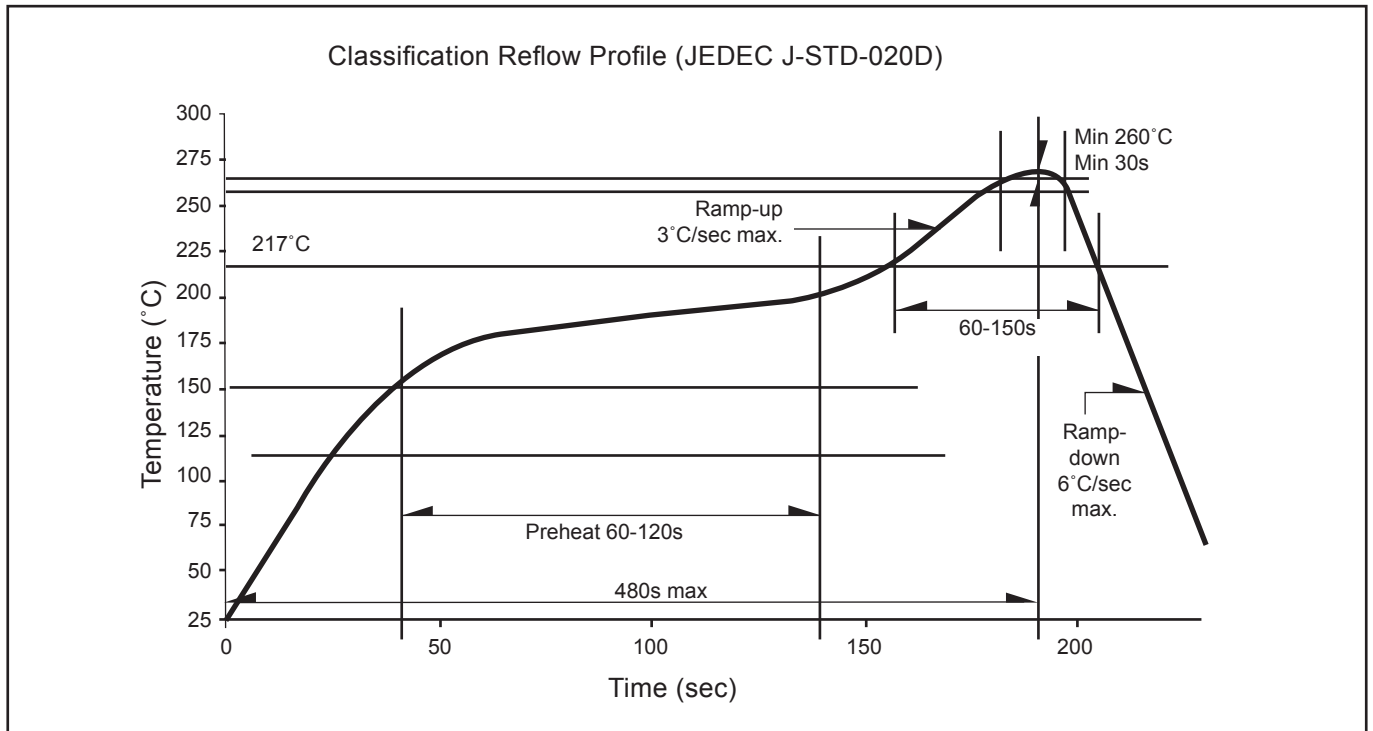

Appendix

1) **Brightness:**

- 1.1 Luminous intensity is measured with an internal reproducibility of $\pm 8 \%$ and an expanded uncertainty of $\pm 11 \%$ (according to GUM with a coverage factor of $k=3$).
- 1.2 Luminous flux is measured with an internal reproducibility of $\pm 8 \%$ and an expanded uncertainty of $\pm 11 \%$ (according to GUM with a coverage factor of $k=3$).

2) **Color:**

- 2.1 Chromaticity coordinate groups are measured with an internal reproducibility of ± 0.005 and an expanded uncertainty of ± 0.01 (accordingly to GUM with a coverage factor of $k=3$).
- 2.2 DOMINANT wavelength is measured with an internal reproducibility of $\pm 0.5\text{nm}$ and an expanded uncertainty of $\pm 1\text{nm}$ (accordingly to GUM with a coverage factor of $k=3$).

3) **Voltage:**

- 3.1 Forward Voltage, V_f is measured with an internal reproducibility of $\pm 0.05\text{V}$ and an expanded uncertainty of $\pm 0.1\text{V}$ (accordingly to GUM with a coverage factor of $k=3$).

Revision History

Page	Subjects	Date of Modification
-	Initial Release	24 Mar 2017
7	Update on Peak Pulse Current Update Package Outline	17 May 2017

NOTE

All the information contained in this document is considered to be reliable at the time of publishing. However, DOMINANT Opto Technologies does not assume any liability arising out of the application or use of any product described herein.

DOMINANT Opto Technologies reserves the right to make changes to any products in order to improve reliability, function or design.

DOMINANT Opto Technologies products are not authorized for use as critical components in life support devices or systems without the express written approval from the Managing Director of DOMINANT Opto Technologies.

About Us

DOMINANT Opto Technologies is a dynamic company that is amongst the world's leading automotive LED manufacturers. With an extensive industry experience and relentless pursuit of innovation, DOMINANT's state-of-art manufacturing and development capabilities have become a trusted and reliable brand across the globe. More information about DOMINANT Opto Technologies, a ISO/TS 16949 and ISO 14001 certified company, can be found under <http://www.dominant-semi.com>.

Please contact us for more information:

DOMINANT Opto Technologies Sdn. Bhd
Lot 6, Batu Berendam, FTZ Phase III, 75350 Melaka, Malaysia.
Tel: +606 283 3566 Fax: +606 283 0566
E-mail: sales@dominant-semi.com
