

857175

70 MHz SAW Filter

Applications

- For Military applications

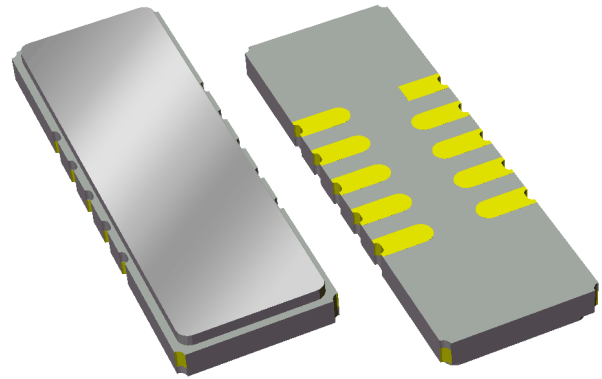

Product Features

- Typical 3 dB bandwidth of 5.7 MHz
- Low loss
- High Attenuation
- Single-ended operation
- Ceramic Surface Mount Package (SMP)
- Small Size
- Dimensions: 19.00 x 6.50 x 1.75mm
- **RoHS** compliant, **Pb**-free

General Description

The 857175 is a high-performance IF SAW filter with a center frequency of 70 MHz and a 3 dB bandwidth of 5.7 MHz.

It features low loss with excellent attenuation, and is designed to be used with a single ended input and output.

This device is RoHS compliant and Pb-free.

Functional Block Diagram

Top view

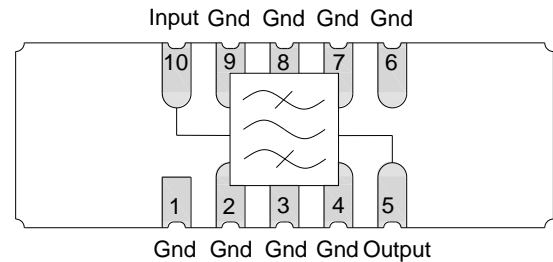

Pin Configuration

Pin #	SE	Description
10		RF Input
5		RF Output
1,6		Ground
2,3,4,7,8,9		Case ground

Ordering Information

Part No.	Description
857175	packaged part
857175-EVB	evaluation board

Standard T/R size = 2000 units/reel.

Specifications

Electrical Specifications ⁽¹⁾

Specified Temperature Range: ⁽²⁾ -55 to +105 °C

Parameter ⁽³⁾	Conditions	Min	Typical ⁽⁴⁾	Max	Units
Center Frequency		-	140	-	MHz
Insertion Loss	at minimum	-	21	24	dB
Lower 1.0 dB Bandedge		-	-	67.65	MHz
Upper 1.0 dB Bandedge ⁽⁵⁾		72.35	-	-	MHz
Lower 3.0 dB Bandedge		-	-	67.3	MHz
Upper 3.0 dB Bandedge ⁽⁵⁾		72.7	-	-	MHz
Lower 40.0 dB Bandedge		66.05	-	-	MHz
Upper 40.0 dB Bandedge ⁽⁵⁾		-	-	73.95	MHz
Amplitude Variation ⁽⁶⁾	67.65 – 72.35 MHz	-	0.5	1.0	dB p-p
Phase Linearity	67.65 – 72.35 MHz	-	3.0	7.0	deg p-p
Group Delay Variation	67.65 – 72.35 MHz	-	70	180	ns p-p
Relative Attenuation	10 – 58 MHz	35	-	-	dB
	58 – 66 MHz	35	-	-	dB
	74 – 82 MHz	35	-	-	dB
	82 – 90 MHz	40	-	-	dB
	90 – 120 MHz	45	-	-	dB
	120 – 145 MHz	40	-	-	dB
	145 – 200 MHz	55	-	-	dB
Source Impedance (single-ended) ⁽⁷⁾	-	-	50	-	Ω
Load Impedance (single-ended) ⁽⁷⁾	-	-	50	-	Ω

Notes:

- All specifications are based on the TriQuint schematic for the main reference design shown on page 3
- In production, devices will be tested at room temperature to a guardbanded specification to ensure electrical compliance over temperature
- Electrical margin has been built into the design to account for the variations due to temperature drift and manufacturing tolerances
- Typical values are based on average measurements at room temperature
- Relative to insertion loss at center frequency
- Is defined as the difference between the maximum and minimum loss within the specified frequency range
- This is the optimum impedance in order to achieve the performance shown

Absolute Maximum Ratings

Parameter	Rating
Operating Temperature	-55 to +105 °C
Storage Temperature	-55 to +105 °C

Operation of this device outside the parameter ranges given above may cause permanent damage.

Reference Design – 50Ω SE Input, 50Ω SE Output

Schematic

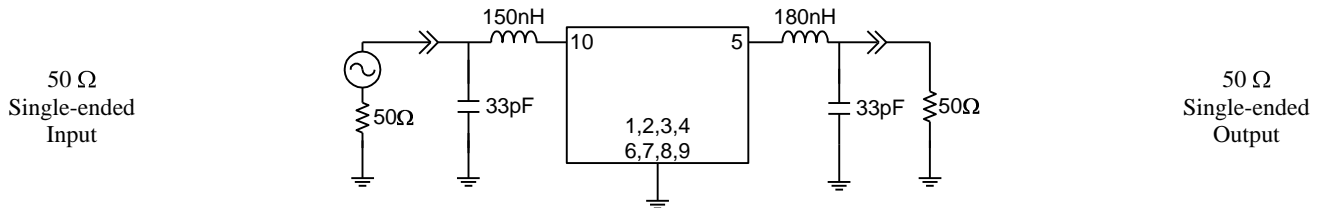

Notes:

1. Actual matching values may vary due to PCB layout and parasitics

PC Board

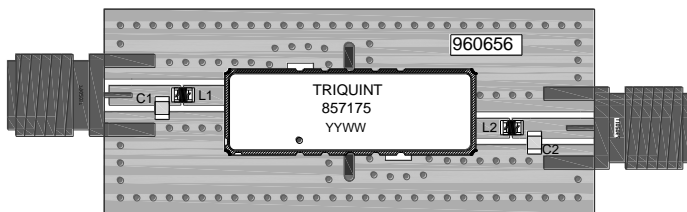

Notes:

- Top, middle & bottom layers: 1 oz copper
- Substrates: FR4 dielectric, .031" thick
- Finish plating: Nickel: 3-8μm thick, Gold: .03-.2μm thick
- Hole plating: Copper min .0008μm thick

Mounting Configuration

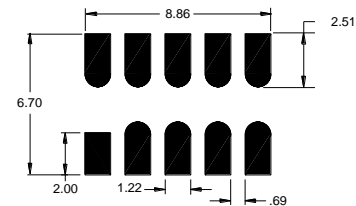

Notes:

1. All dimensions are in millimeters.
2. This footprint represents a recommendation only.

Bill of Material

Reference Desg.	Value	Description	Manufacturer	Part Number
L1	150nH	Coil Wire-wound, 0805, 5%	Coilcraft	0805CS-151XJLC
L2	180nH	Coil Wire-wound, 0805, 5%	Coilcraft	0805CS-181XJLC
C1	33pF	Chip Capacitor, 0805, 5%	MuRata	GRM2165C1H330JZ01
C2	33pF	Chip Capacitor, 0805, 5%	MuRata	GRM2165C1H330JZ01
SMA	N/A	SMA connector	Radiall USA Inc.	9602-1111-018
PCB	N/A	3-layer	multiple	960656

Typical Performance (at room temperature)

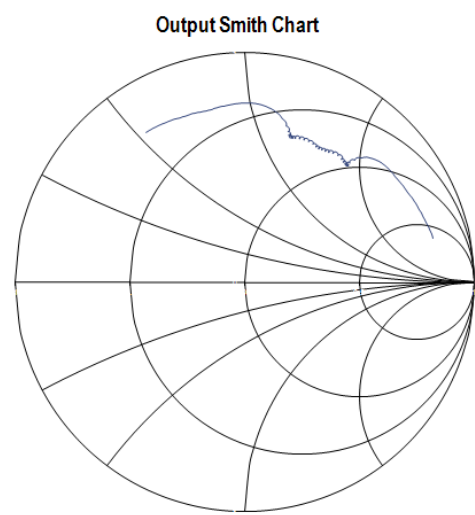
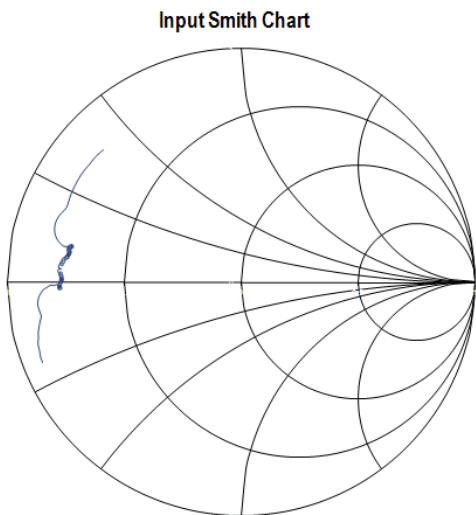
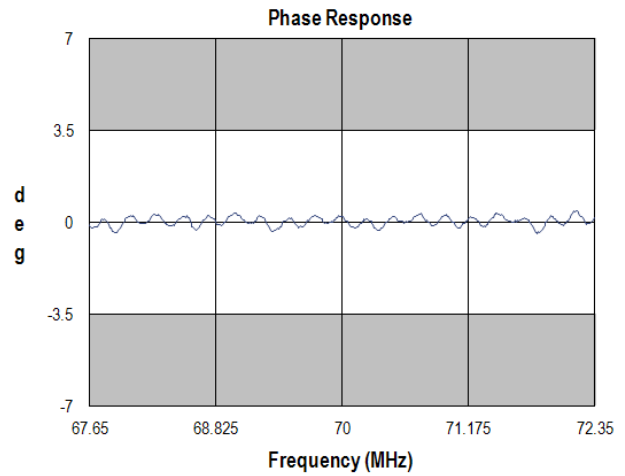
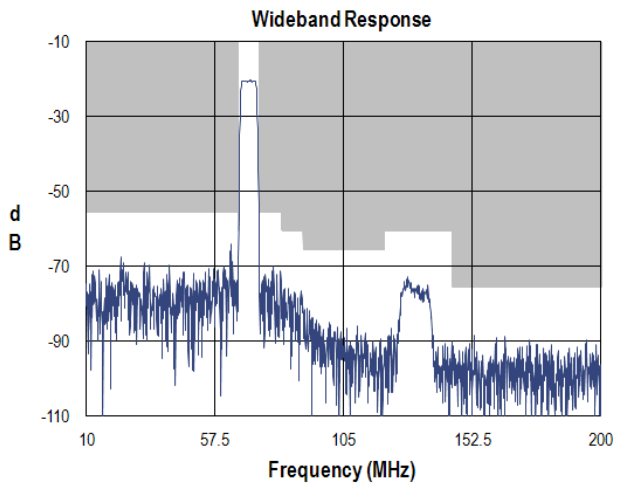
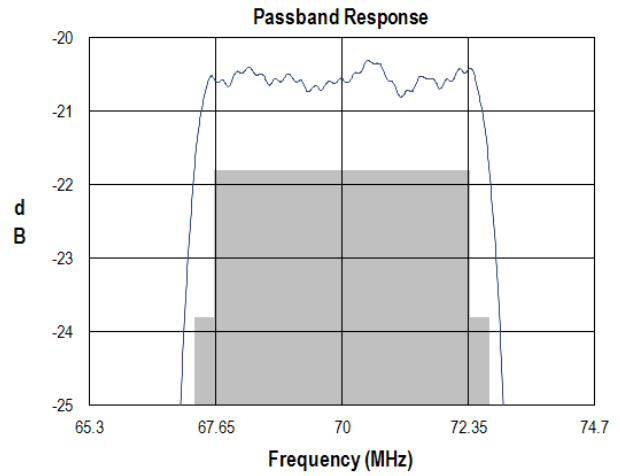
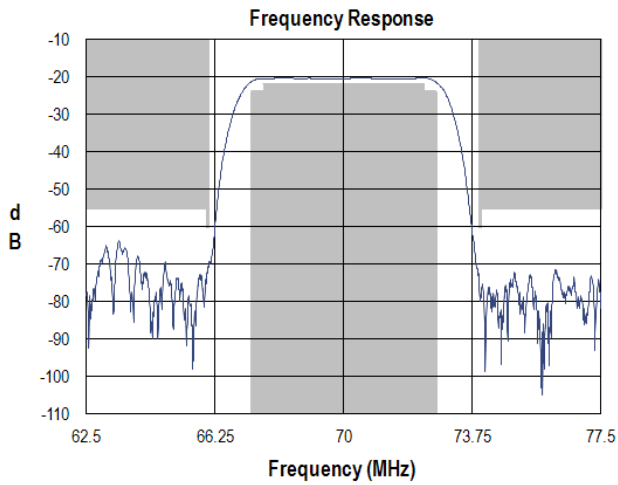

Mechanical Information

Package Information, Dimensions and Marking

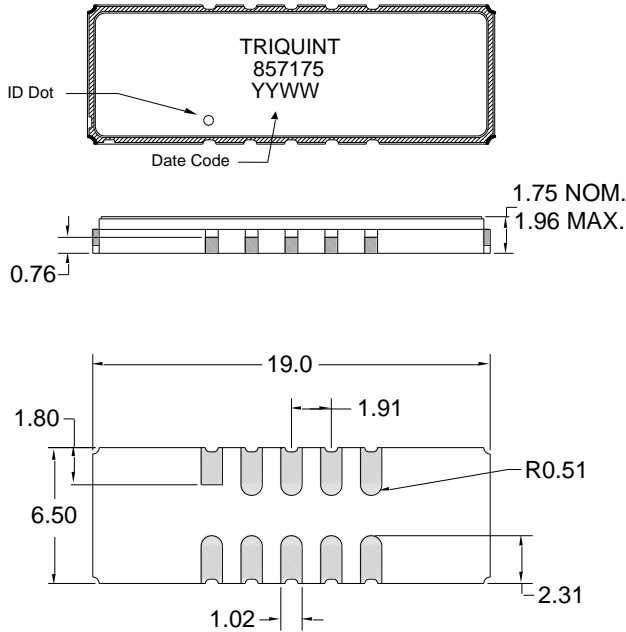

Package Style: SMP-75
 Dimensions: 19.00 x 6.50 x 1.75mm

Body: Al_2O_3 ceramic
 Lid: Kovar, Ni plated
 Terminations: Au plating 0.5 - 1.0 μ m, over a 2-6 μ m Ni plating

All dimensions shown are nominal in millimeters
 All tolerances are ± 0.15 mm except overall length and width ± 0.10 mm

The date code consists of: YY = last two digits of the year,
 WW = work week

Tape and Reel Information

Standard T/R size = 2000 units/reel. All dimensions are in millimeters

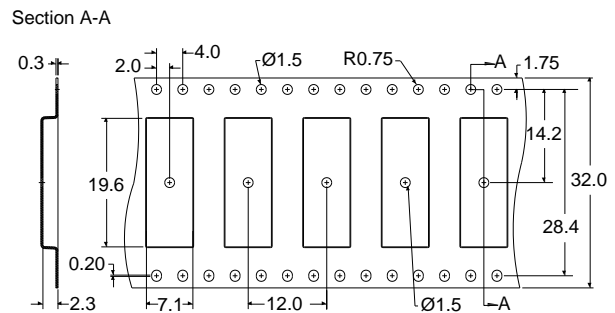
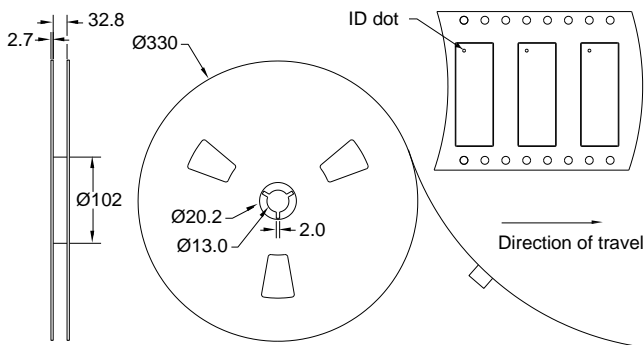

Product Compliance Information

ESD Information



Caution! ESD-Sensitive Device

ESD Rating: TBD

Value: Passes \geq TBD V min.
Test: Human Body Model (HBM)
Standard: JEDEC Standard JESD22-A114

ESD Rating: TBD

Value: Passes \geq TBD V min.
Test: Machine Model (MM)
Standard: JEDEC Standard JESD22-A115

MSL Rating

Devices are Hermetic, therefore MSL is not applicable.

Solderability

Compatible with the latest version of J-STD-020, lead free solder, 260°C

Refer to [Soldering Profile](#) for recommended guidelines.

This part is compliant with EU 2002/95/EC RoHS directive (Restrictions on the Use of Certain Hazardous Substances in Electrical and Electronic Equipment).

This product also has the following attributes:

- Halogen Free (Chlorine, Bromine)
- Antimony Free
- TBBP-A (C₁₅H₁₂Br₄O₂) Free
- PFOS Free
- SVHC Free

Contact Information

For the latest specifications, additional product information, worldwide sales and distribution locations, and information about TriQuint:

Web: www.triquint.com Tel: +1.407.886.8860
Email: info-sales@tqs.com Fax: +1.407.886.7061

For technical questions and application information:

Email: applications.engineering@tqs.com

Important Notice

The information contained herein is believed to be reliable. TriQuint makes no warranties regarding the information contained herein. TriQuint assumes no responsibility or liability whatsoever for any of the information contained herein. TriQuint assumes no responsibility or liability whatsoever for the use of the information contained herein. The information contained herein is provided "AS IS, WHERE IS" and with all faults, and the entire risk associated with such information is entirely with the user. All information contained herein is subject to change without notice. Customers should obtain and verify the latest relevant information before placing orders for TriQuint products. The information contained herein or any use of such information does not grant, explicitly or implicitly, to any party any patent rights, licenses, or any other intellectual property rights, whether with regard to such information itself or anything described by such information.

TriQuint products are not warranted or authorized for use as critical components in medical, life-saving, or life-sustaining applications, or other applications where a failure would reasonably be expected to cause severe personal injury or death.