

SG - 112

The SG – 112 reflective sensor for paper sensing combine high - output GaAs IRED with high sensitive phototransistor. It is most applicable to paper sensor.

FEATURES

- PWB direct mount type
- The most suitable detection distance : 3.0mm
- With the installation positioning boss
- Low profile

APPLICATIONS

- Printers
- Facsimiles
- CD – ROM drives
- DVD – ROM drives

DIMENSIONS

(Unit : mm)

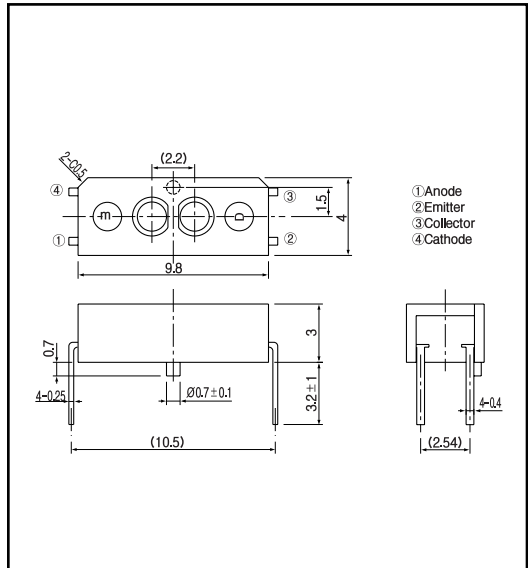

MAXIMUM RATINGS

(Ta=25)

	Item	Symbol	Rating	Unit
Input	Power dissipation	P _D	75	mW
	Forward current	I _F	50	mA
	Reverse voltage	V _R	5	V
	Pulse forward current ^{*1}	I _{FP}	1	A
Output	Collector power dissipation	P _C	75	mW
	Collector current	I _C	20	mA
	C - E voltage	V _{CEO}	30	V
	E - C voltage	V _{ECD}	5	V
	Operating temp. ^{*2}	T _{opr.}	- 20 ~ +85	
	Storage temp. ^{*2}	T _{stg}	- 30 ~ +85	
	Soldering temp. ^{*3}	T _{sol.}	260	

*1. pulse width : t w 100 μsec, period : T=10msec.

*2. No icebound or dew

*3. For MAX.5 seconds at the position of 1mm from the package

ELECTRO-OPTICAL CHARACTERISTICS

(Ta=25)

	Item	Symbol	Conditions	Min.	Typ.	Max.	Unit.
Input	Forward voltage	V _F	I _F =20mA		1.2	1.4	V
	Reverse current	I _R	V _R =5V			10	μA
	Peak wavelength	λ _p	I _F =20mA		940		nm
Output	Collector dark current	I _{CEO}	V _{CE} =10V		1	100	nA
	Light current	I _C	I _F =20mA, V _E =5V, L=2mm	0.2		2.4	mA
Transmissi	Package current	I _{CEOD}	I _F =20mA, V _E =5V(Non-reflector)			20	μA
	C - E saturation voltage	V _{CE(sat)}	I _F =20mA, I _C =0.1mA		0.15	0.4	V
	Rise time	t _r	V _{CC} =5V, I _C =0.3mA, R=100		5		μsec.
	Fall time	t _f			5		μsec.

Photo interrupters(Reflective)

SG - 112

Collector power dissipation Vs. Ambient temperature

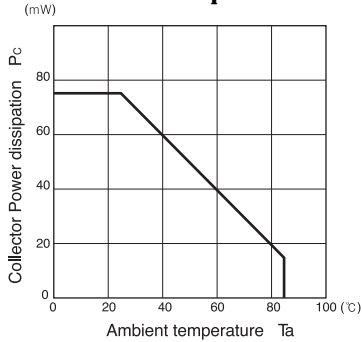

Forward current Vs. Forward voltage

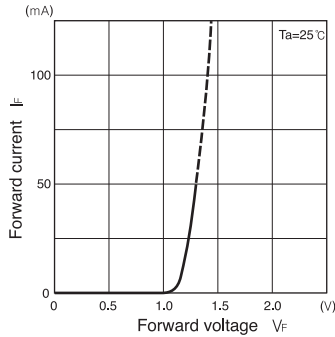

Light current Vs. Forward current

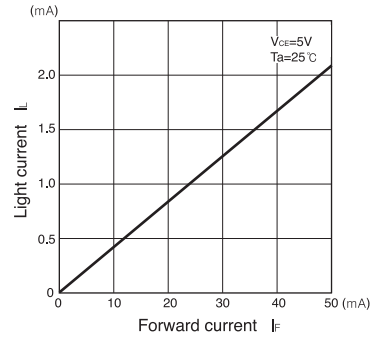

Light current Vs. Collector-Emitter voltage

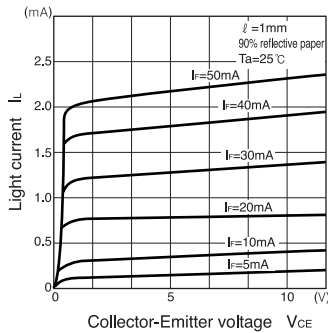

Relative light current Vs. Ambient temperature

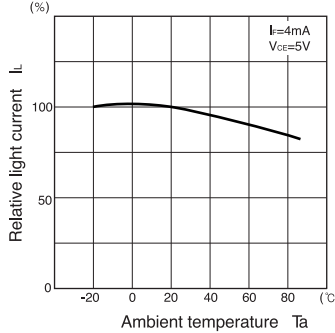

Dark current Vs. Ambient temperature

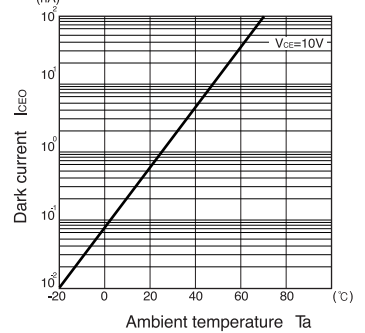

Switching time Vs. Load resistance

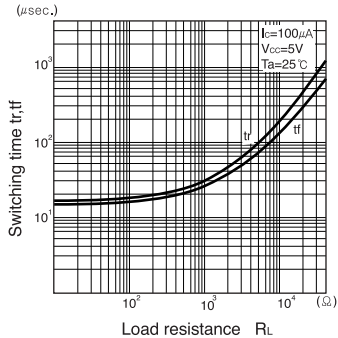

Relative light current Vs. Moving distance

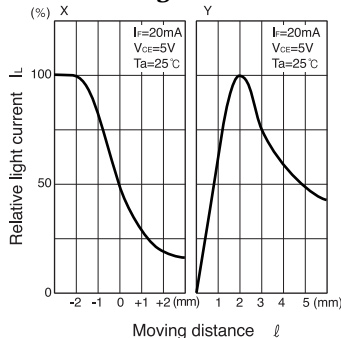

Switching time measurement circuit

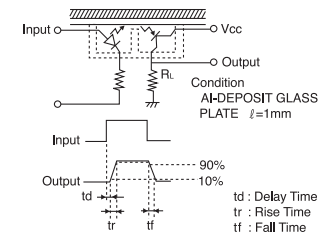

Method of measuring position detection characteristic

