

E3X-DA-S

Digital Fiber Sensors



Perfection Transcended!
A Wealth of Advanced Functions
for Easy and Reliable Application



Innovation
in the Solution Age

Evolution and Perfection

The next-generation platform for a wide range of sensing

- point 1 The industry's first **Power Tuning Function** in a digital sensor.
- point 2 Large, **Easy-to-Read Displays** that are clear even from a distance. Seven convenient display formats.
- point 3 Stable long-term performance achieved with **OMRON's Auto Power Control (APC)** function.
- point 4 A wide array of **Advanced Functions** for even more applications.
- point 5 The same **Ease-of-Use** as the E3X-DA-N Amplifier.
- point 6 **Environmentally Friendly** design.
- point 7 Improved **Mobile Console**.



Industry's First Power Tuning Function in a Digital Sensor.

No complicated mode settings.

Troublesome power adjustments have been eliminated, so it isn't necessary to select from power mode settings, such as long-distance mode, standard mode, and short-distance mode. When the MODE Key is pressed once, the power tuning function shifts the power level so that the present incident level is set to the ideal level (2000 on the digital display.)

Patent Pending

Earlier Method

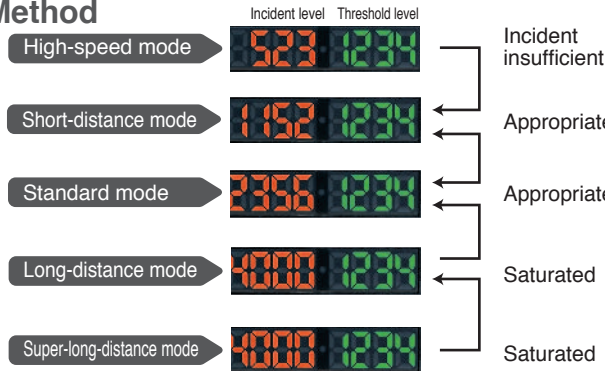

The best mode for each application was selected from several power modes.

New Method

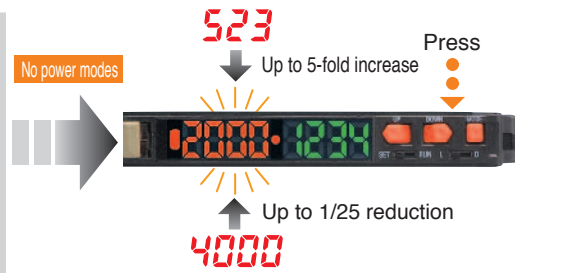

The Sensor can be used immediately without setting the mode. If the incident light level is too high or too low, just press the Mode key to achieve the optimum status.

Insufficient light or saturation at short distances can be corrected.

The power tuning range is extended to the allowable limits to eliminate problems such as insufficient light or detection failures due to saturation. If the installation distance is too short, the incident light may saturate (i.e., to a digital incident level of 4,000), preventing detection. The power can be tuned down to 1/25th of the default setting for stable detection even at close range.

Press



Variations between different Sensors can be eliminated.

Threshold levels had to be set and maintained separately for individual Sensors due to variations in the digital light levels measured by each Sensor. With power tuning, the incident level can be fine-tuned so the same threshold level can be set for each Sensor in an application. Maintenance is also simplified because it is easier to recognize measurement levels that have shifted during operation.

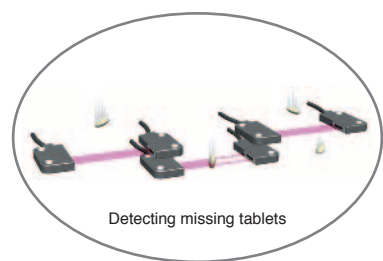

Earlier Method



Digital light levels vary due to individual differences in the Sensors, so the threshold levels must be set individually.

New Method



All of the Amplifiers are set to the same digital light level, so the same threshold level can be set and maintained for the Sensors.

Large, Easy-to-Read Displays: Clear Even from a Distance

The displays are large and easy-to-read, despite the small case.

Settings can be made more simply and confidently with two digital displays. For example, the threshold value can be changed while reading the incident level or a setting can be changed while confirming the setting's function item number.

Large, bright operation indicator (like earlier models)

RUN mode



SET mode

Function numbers added to function items.

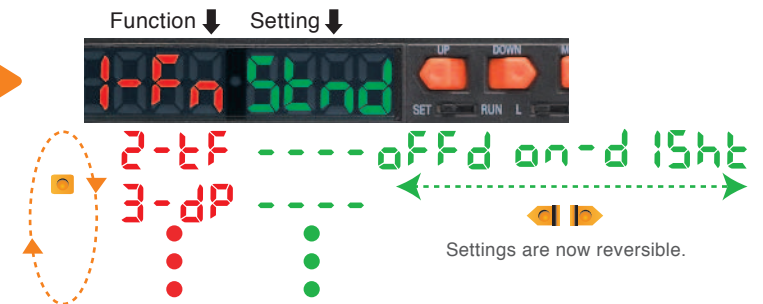

Seven Convenient Display Formats

Patent Pending

An incident level/threshold display, percentage/threshold display, and large bar graph display have been added, so you can select the best display method for the application.

Incident Level/Threshold Display

Incident level Threshold level

Change the threshold level while reading the incident level.

Percentage/Threshold Display

Incident level Threshold level

Verify the difference between the incident level and threshold level while setting the threshold level.

Large Bar Graph Display

Bar display

Check the incident level intuitively. Ideal when it is better to view an analog display instead of the actual digital level.

Incident Level/Peak Hold Display

Incident level Peak hold

Simultaneously display the peak hold level and present incident level. The optical axis can be adjusted more easily and surely by checking the peak hold level while adjusting the optical axis.

Peak Hold/Bottom Hold Display

2010 2055

1350 1280

Threshold level

Display the peak level when light was brightest and bottom level when light was dimmest. The digital levels of high-speed objects can be read precisely. (Refreshing the hold level was changed from a fixed time to synchronizing with the output, so the peak and bottom hold values can be checked with certainty.)

Stable, Long-term Performance with OMRON's APC Function

OMRON provides the industry's most stable long-term detection **Highest Level of Stability** by using new 4-element LEDs and an APC (Auto Power Control) circuit.

In addition to our unique APC circuit used in the E3X-DA-N Amplifiers to compensate for the deterioration of the LED, the E3X-DA-S uses 4-element LEDs to counteract the deterioration of the light-emitting elements over time and achieve the industry's most stable long-term detection performance.

Furthermore, the circuit is designed with excess light capacity, so the Sensors can be used with high stability regardless of whether the APC circuit is ON or OFF.

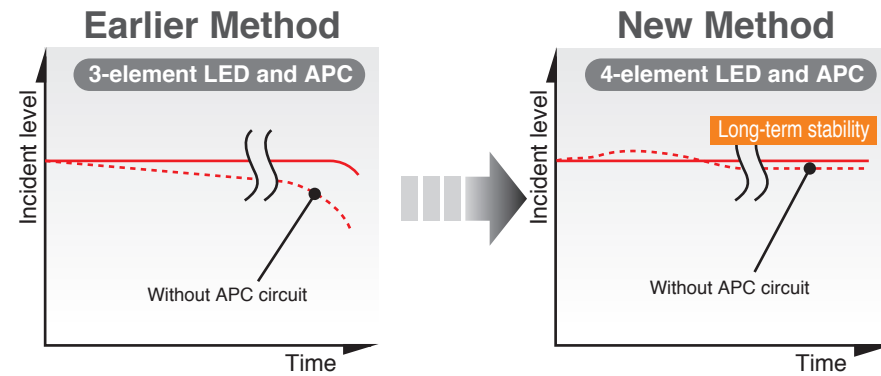

Compensate for the effects of contaminants and temperature variation with differential operation mode. **(Advanced Models)**

This operation mode uses a special OMRON algorithm to compensate for slight light level changes due to dirt or temperature variations and detect only the light level changes due to the workpiece.

Slight light level changes can be detected with stability and precision, eliminating the need for time-consuming manual adjustments for light level changes.

With the Twin-output Amplifiers, output 2 can function as an alarm output (light level operation) to indicate when the light level has changed due to dirt or other causes. **Patent Pending**

Light Level Operation (Normal Operation)

Judges light level changes by comparing the incident level and threshold level.

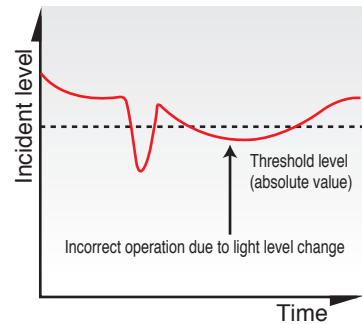

The light level varies due to dirt, temperature variations, or other environmental factors.

Incorrect operation

Differential Operation

Judges light level changes by comparing the incident level to a time-averaged incident level.

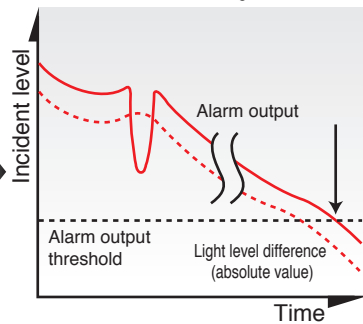

Detecting differences in the light level enables setting more subtle light level differences.

Minute changes are detected reliably.

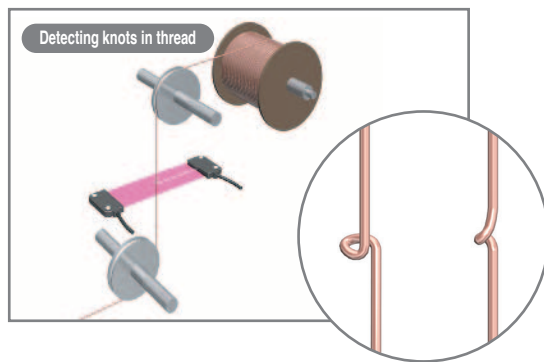
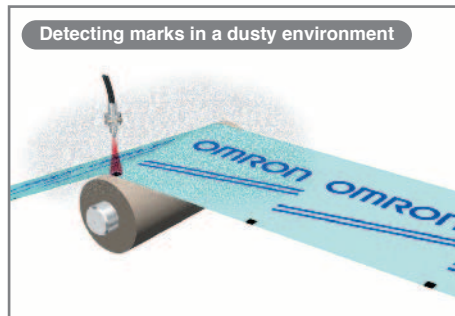

Many Advanced Functions for Even More Applications

In super-high-speed mode, it is the **Fastest in the Industry** fastest digital model at 48 μ s. (Standard Models)

Provides high-speed response for miniature workpieces, such as chip parts and devices with short tact times.

Three kinds of timer functions are supported. The timers can be set between 1 ms and 5 s.

A one-shot timer is supported in addition to the ON-delay and OFF-delay timers.

The Amplifier's ON time can be fixed, which is useful during high-speed workpiece detection.

Area output function can be used for range judgement. **(Advanced Twin-output Models)**

Operations that required multiple Sensors, such as height measurement, can be performed with just one Sensor. Two threshold levels can be set to easily output within-range and out-of-range outputs.

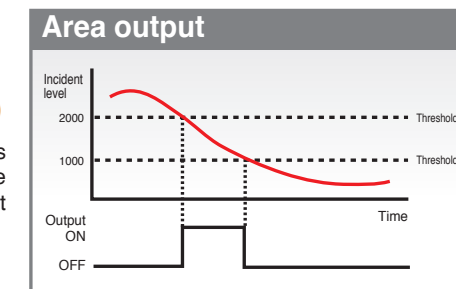

Remote input function can control the Sensor remotely. **(Advanced External-input Models)**

Input signals can make various remote settings, such as teaching operations, power tuning, and emitter OFF. This model is ideal for diverse needs, such as checking Sensor operation remotely before operation or making settings remotely because teaching has to be performed often for frequent workpiece model changes.

The counter function can output signal after counter counts up or down. **Patent Pending** **(Advanced External-input Models)**

A counter function is built-in, so the number of workpieces can be counted without a separate counter or small PLC that used to be required.

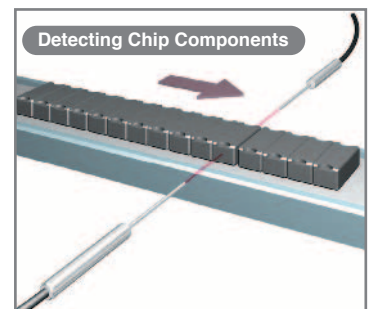
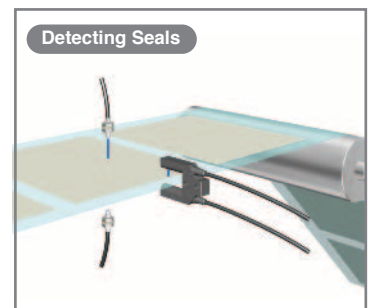
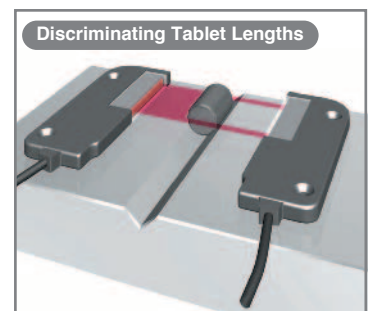
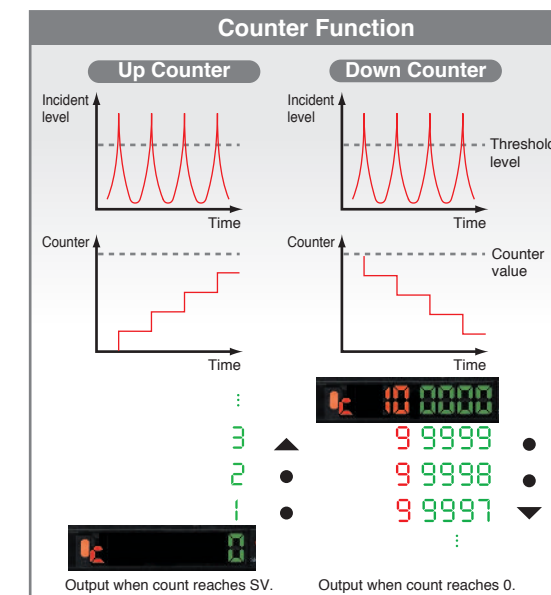

The Same Ease-of-Use as the E3X-DA-N

The E3X-DA-S uses OMRON's own simplified wiring connectors that were introduced with the E3X-DA-N.

Patent Pending
Japan patent number 3266198

In Amplifiers with Connectors, the power supply is distributed to slave connectors through a single master connector. This design has three major advantages.

1. Wiring time is significantly reduced.
2. Relay connectors are unnecessary, so wiring takes up less space.
3. Storage and maintenance are simpler because it isn't necessary to distinguish between master connector and slave connectors on the Amplifier.

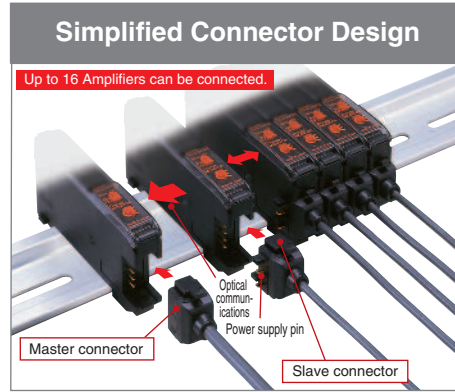

Reduced Power Wiring Saves Space

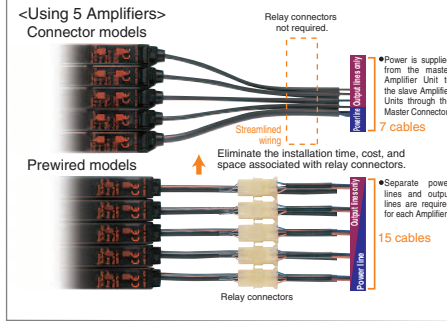

Optical communications prevents mutual interference.

Mutual interference is prevented with optical communications, so up to 10 Amplifiers can be mounted together.

(The number of Amplifiers depends on the operating conditions.)

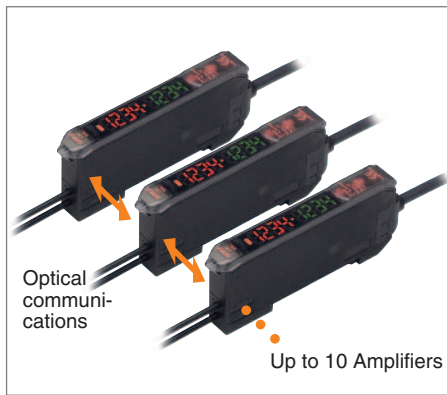
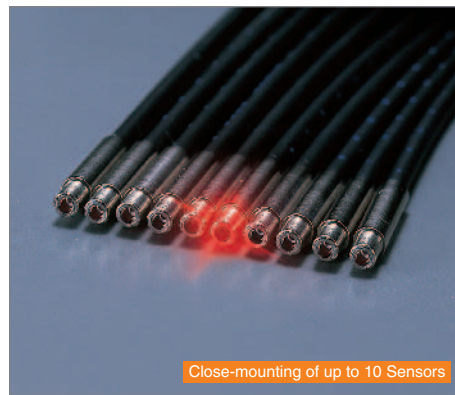

Zero reset function immediately resets the digital display to 0.

Patent Pending
Japan patent number 3255229

The zero reset function can immediately reset the digital display to 0 at any time. By setting the reference value to 0, the threshold value can be set while monitoring differences in incident light levels. The threshold value will also shift simultaneously when the zero reset button is pressed.

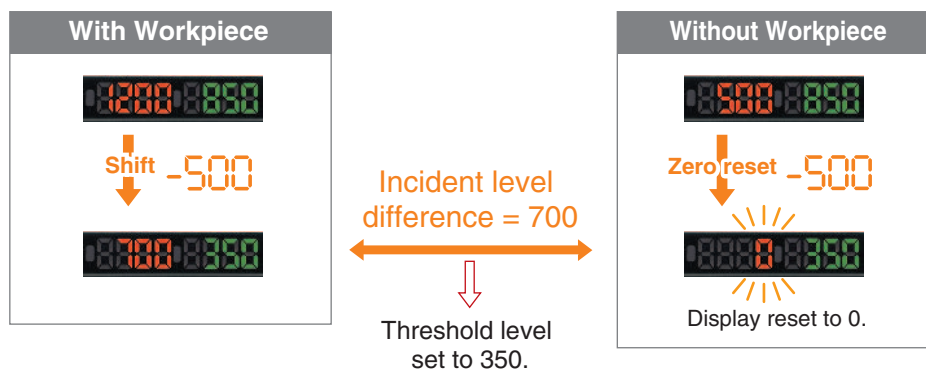

Reversible Digital Display (Reverse Mode)

The digital display can be reversed to match the Amplifier's mounting direction.

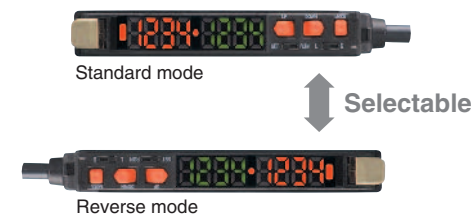

Environmentally Friendly Design

Environmentally friendly features are essential in truly high-performance products.

1 Materials containing lead have been completely eliminated. First in the industry

The Fiber Sensor is the first in the industry to use environmentally friendly lead-free solder.



2 The digital display can be turned OFF or dimmed during operation. Eco-mode

When the digital display is viewed infrequently during operation, current consumption can be reduced by dimming the display or turning it OFF entirely. The display will light up again automatically when an operation key is touched. (Eco-mode can be set from the Mobile Console only.)

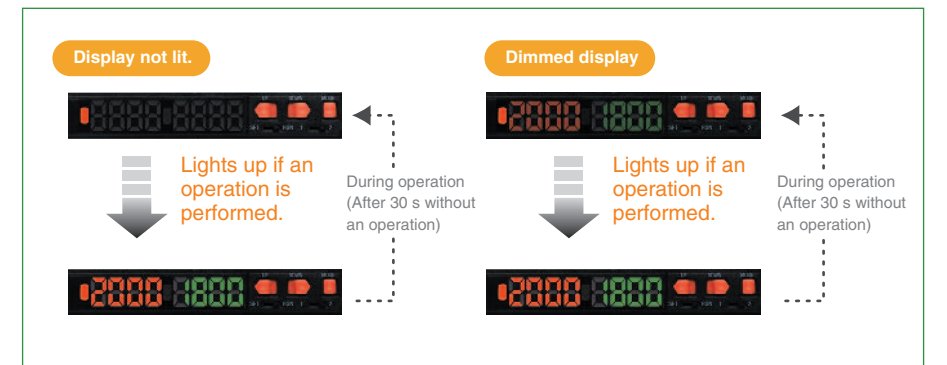

3 Cable disposal is not required during maintenance.

In addition to saving space and reducing wiring time, the new connector design eliminates the need to dispose of cables together with the Amplifiers.

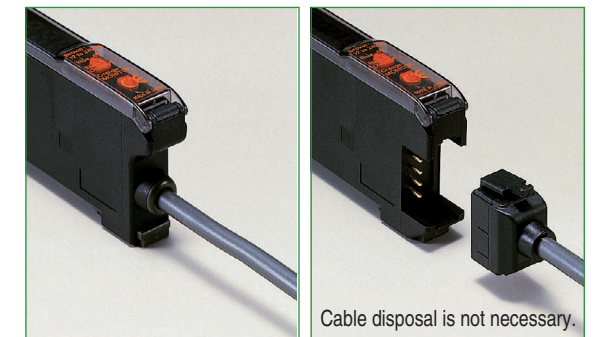

Further Improvements to the Mobile Console



Can also be used with Photoelectric Sensors with Separate Digital Amplifiers.



E3X-MC-S Mobile Console

Group Power Tuning

With the group power tuning function, power tuning is possible for multiple Sensors at the same time.

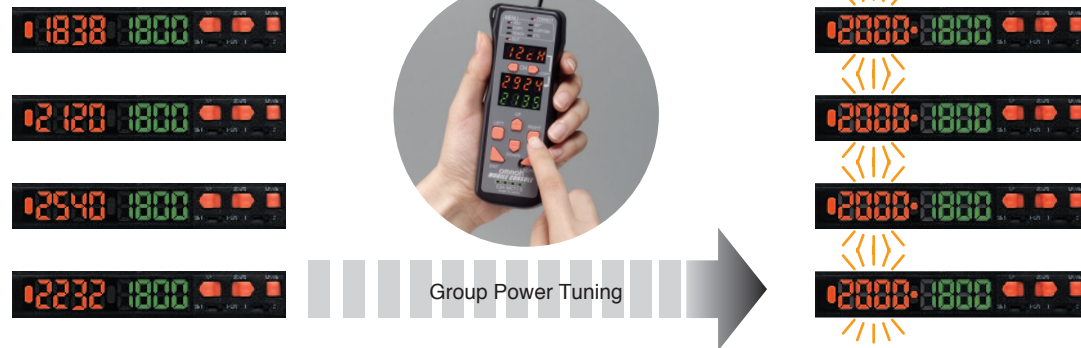

Easily set multiple Sensors.

Improved Mode Lock Function

Settings can be customized for different applications by locking out unnecessary function blocks within function settings.

Application		Function Block		
		Manual setting	Teaching	Function setting
Manual	Set for manual operation.	Operation OK	Locked	Locked
Teaching	Set for teaching operation.	Locked	Operation OK	Locked
Teaching + Manual	Set for teaching + manual operation.	Operation OK	Operation OK	Locked

The Age of User-customizable Sensors.

Retains all of the Previous Advantages of the Mobile Console.

New and Improved Fiber Sensor and Mobile Console.

Settings, teaching, and fine-tuning can be performed at the fiber tip.

The Mobile Console can be used for settings and teaching at the tip of the fiber. Difficult adjustments can be made while checking the workpiece position. Even if the Amplifier and Sensor head are separated during operation, it is still possible to flash the Sensor head and display the amplifier channels.



With Group Teaching, Teach Multiple Amplifiers Simultaneously.

The tedious teaching that had to be performed separately for each Amplifier can now be performed for several Amplifiers at once using the Mobile Console.



Copying Settings within the Same Group

Settings such as mode or threshold settings in an Amplifier or bank can be copied to all of the Amplifiers in the same group.



Copying Settings to Other Groups

The settings for a group of Amplifiers on one machine can be copied to a group of Amplifiers on another machine. (The settings can also be copied to and from banks.)

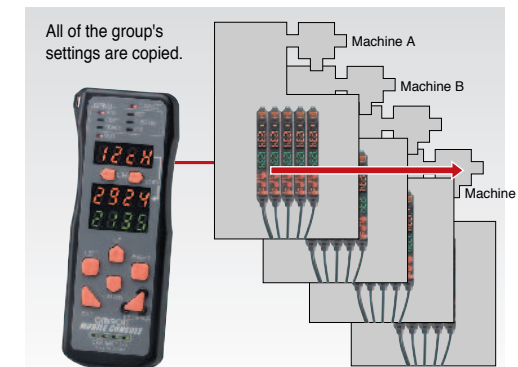

OMRON Corporation
Industrial Automation Company

Application Sensors Division
Sensing Devices and Components Division H.Q.

Shiokoji Horikawa, Shimogyo-ku,
Kyoto, 600-8530 Japan
Tel: (81)75-344-7068/Fax: (81)75-344-7107

Regional Headquarters

OMRON EUROPE B.V.

Sensor Business Unit,
Carl-Benz-Str. 4, D-71154 Nufringen,
Germany
Tel: (49)7032-811-0/Fax: (49)7032-811-199

OMRON ELECTRONICS LLC

1 East Commerce Drive, Schaumburg, IL 60173
U.S.A.
Tel: (1)847-843-7900/Fax: (1)847-843-8568

OMRON ASIA PACIFIC PTE. LTD.

83 Clemenceau Avenue,
#11-01, UE Square,
239920 Singapore
Tel: (65)6835-3011/Fax: (65)6835-2711

OMRON CHINA CO., LTD. BEIJING OFFICE

Room 1028, Office Building,
Beijing Capital Times Square,
No. 88 West Chang'an Road,
Beijing, 100031 China
Tel: (86)10-8391-3005/Fax: (86)10-8391-3688

In the interest of product improvement, specifications are
subject to change without notice.

Authorized Distributor:

This document provides information mainly for selecting
suitable models. Please read the Instruction Sheet
carefully for information that the user must understand
and accept before purchase, including information on
warranty, limitations of liability, and precautions.

E3X-MDA Super Dual Fiber Sensor

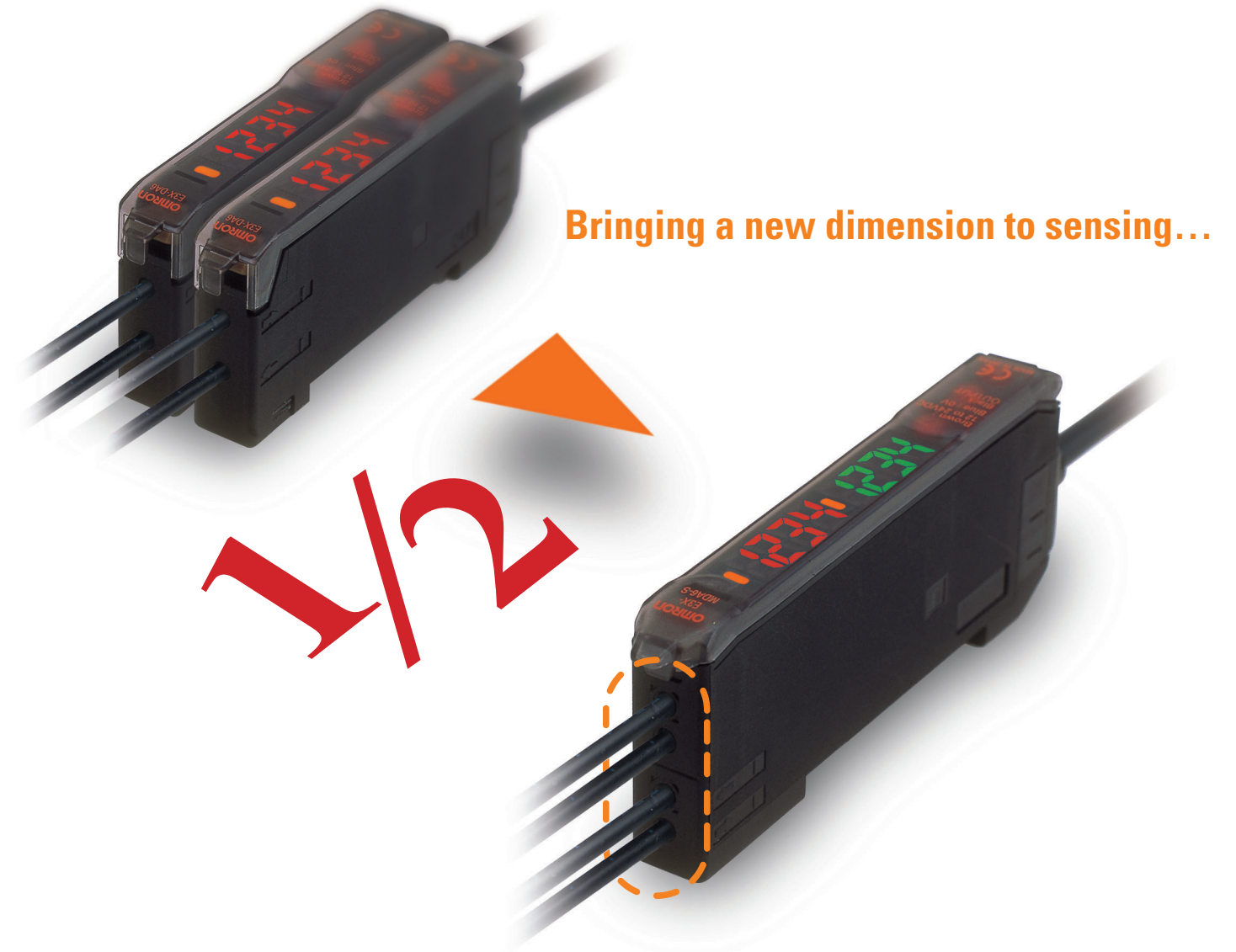
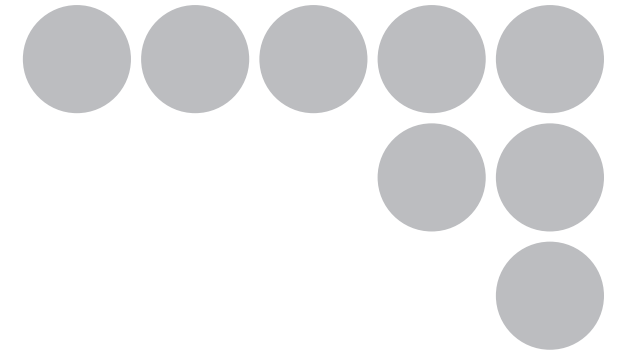

...the 2-channel amplifier has arrived.

This document provides information mainly for selecting suitable models.
Please read the Instruction Sheet carefully for information that the user must understand and accept before purchase, including information on warranty, limitations of liability, and precautions.

OMRON Corporation
Industrial Automation Company

Sensing Devices Division H.Q.
Industrial Sensors Division
Shiokoji Horikawa, Shimogyo-ku,
Kyoto, 600-8530 Japan
Tel: (81)75-344-7022
Fax: (81)75-344-7107

Regional Headquarters

OMRON EUROPE B.V.
Sensor Business Unit, Carl-Benz-Str. 4,
D-71154 Nufringen, Germany
Tel: (49)7032-811-0/Fax: (49)7032-811-199

OMRON ELECTRONICS LLC
1 East Commerce Drive, Schaumburg, IL 60173 U.S.A.
Tel: (1)847-843-7900/Fax: (1)847-843-8568

OMRON ASIA PACIFIC PTE. LTD.
83 Clemenceau Avenue, #11-01, UE Square,
239920 Singapore
Tel: (65)6835-3011/Fax: (65)6835-2711

OMRON (CHINA) CO., LTD.
Room 2211, Bank of China Tower,
200 Yin Cheng Road (M),
Shanghai, 200120 China
Tel: (86)21-5037-2222/Fax: (86)21-5037-2200

Authorized Distributor:

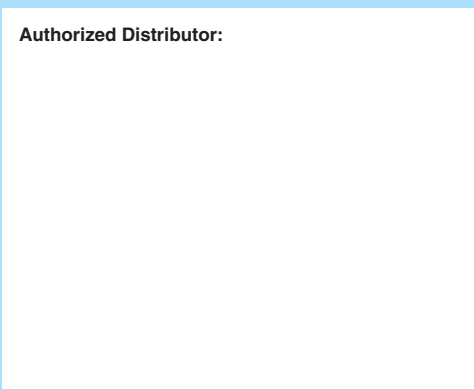

Having problems gang-mounting Fiber Sensor Amplifier Units in tight spaces?

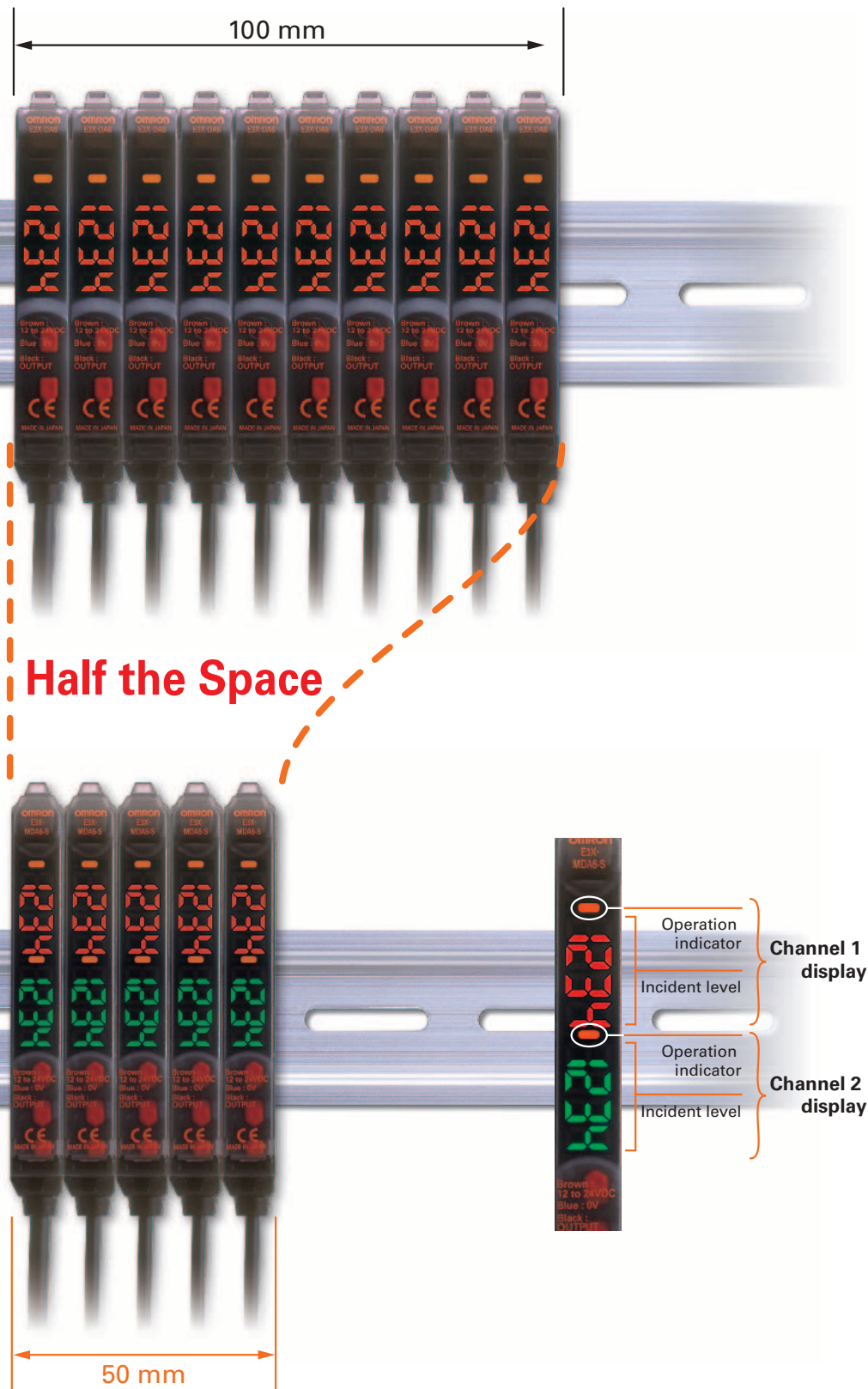

Slimmest in the industry — 5 mm per channel. Patent pending

Two Amplifiers squeezed into a body of width 10 mm.
Remarkable space saving of approx. 50%.
Power saving of approx. 40%.
(Savings per channel compared with existing products.)



Equipped with AND/OR control output. Patent pending

Two types of control output possible with one Sensor (AND/OR).
Compact PLCs and Sensor Controllers no longer required.

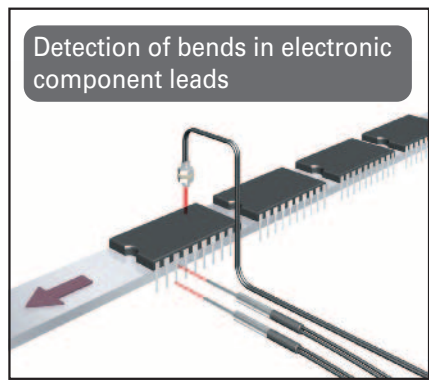
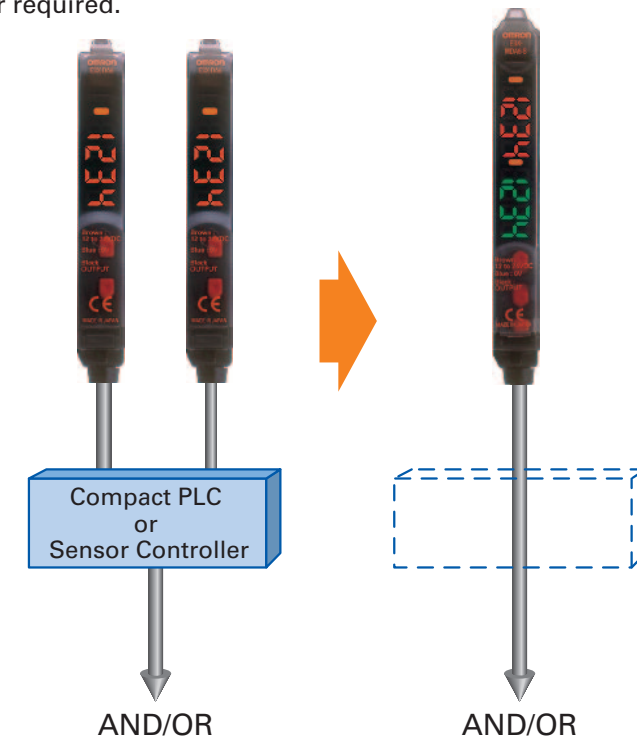

Flexible control with Mobile Console.

The Mobile Console, which can also be used with the E3X-DA-S, allows handheld operation of the Fiber Head even when it is separated from the Amplifier.



An impressive lineup of Digital Amplifiers to handle a wide variety of applications.

A host of remarkable functions inside a compact body. A complete lineup of Sensor Heads to handle an even wider range of applications. This is the platform for OMRON's sensing technology.

The Digital Amplifiers achieve a maximum response time of 48 μs.

Standard Models

Models with Cables

(E3X-DA11-S)

Models with Connectors

Equipped with OMRON's own easy-wiring connector.

(E3X-DA6-S)

Advanced Models

Twin-output Models

Two threshold values can be set. Judgement and self-diagnosis output available.

(Representative model: E3X-DA6TW-S)

External-input Models

The Sensor can be controlled externally. Equipped with counting function.

(Representative model: E3X-DA6RM-S)

A wide variety of color variations available. Equipped with APC circuit for more stable detection.

Mark-detecting Models and Infrared Models

Models with Green LED

(Representative model: E3X-DAG6-S)

Models with Blue LED

(Representative model: E3X-DAB6-S)

Infrared Models *Available Soon*

(Representative model: E3X-DAH6-S)

NEW Two Amplifiers squeezed into a single, compact Unit. AND/OR output available.

2-channel Models

(Representative model: E3X-MDA6)

Maximize Fiber Amplifier potential using remote setting, copying, and other functionality.

Mobile Console

(E3X-MC11-S)

Linear Platform

High-resolution sensing using laser and magnetic technology

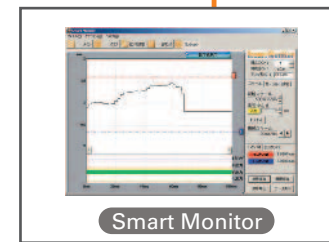

Laser-type Smart Sensors ZX-L Series



An improved lineup for smarter sensing

Inductive Displacement Smart Sensors ZX-E Series

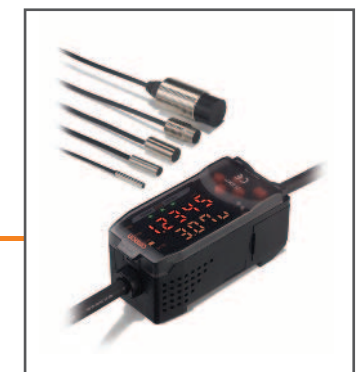

A lineup of Smart Sensors that use the eddy current method

ON/OFF Platform

A common platform for Fiber Sensors and Sensors with Separate Amplifiers



Digital Fiber Sensors E3X-DA-S/MDA Series



Refinement and a new dimension that goes beyond superior performance.

Laser-type Photoelectric Sensors with Separate Amplifiers E3C-LDA Series



Photoelectric Sensors with Separate Digital Amplifiers have joined the Smart Sensor family.

New Models That Counteract the Decline in Operating Rates Caused by Dust and Dirt

Advanced ATC Models

- **Active Threshold Control (ATC)**
Automatically adjusts the threshold value.
- **ATC Error Output (Selectable Function)**
Provides an error output when ATC does not adjust the threshold value.
- **Alarm Output (Selectable Function)**
Provides an alarm when maintenance is required.

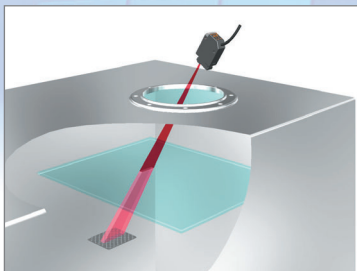

Glass substrate detection through view ports

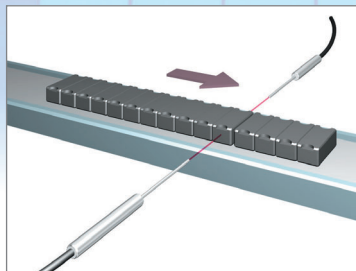

Chip component detection



Digital Laser Sensors E3C-LDA□AT

Digital Fiber Sensors E3X-DA□AT-S

Technology

Intelligently Solve Problems Onsite with ATC Function

A unique OMRON algorithm has been used that can determine whether changes have been caused by dust and dirt or by differences in workpieces.

The threshold value is automatically adjusted by the Sensor according to changes to increase equipment operating rates by reducing sensing errors. This is particularly true in applications requiring high-precision detection.

■ Fixed Threshold Value (Previous Models)

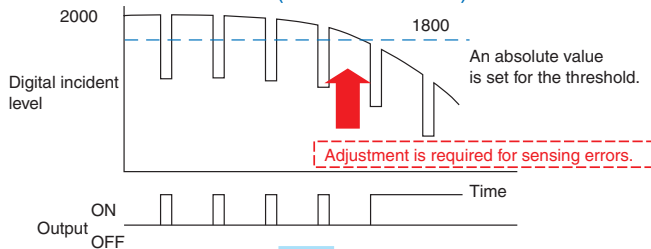

■ Active Threshold Control (ATC Models)

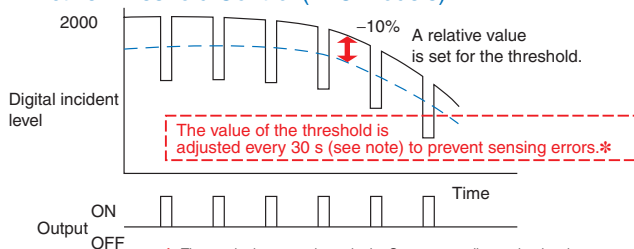

* The monitoring range is set in the Sensor according to the threshold value. The threshold value is adjusted according to changes within this range.

The *DIN*C Engine for High-performance Sensing

OMRON's many years of accumulated sensing technology and high-speed digital processing techniques merge to meet onsite needs. Our goal is high-performance sensing that provides easy, reliable application.

Reliable Detection of Small Workpieces

12-bit A/D converter (4,000 resolution),
high-speed response of 48 μs (Fiber Sensors)

Fine Sensing

Automatic Compensation for External Changes

Active Threshold Control (ATC)

Consistent Emitter Power

Auto Power Control (APC)

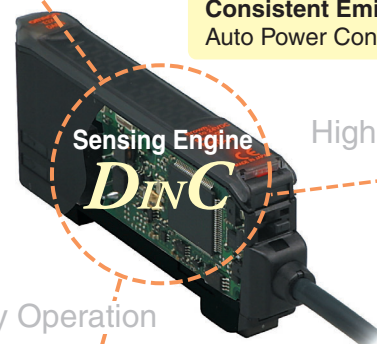

High Performance

Easy Operation

Easy-to-read Displays Even at a Distance



Intelligent Display

Eliminates the Need for Distance Mode Settings



Power Tuning

Ordering Information

Digital Fiber Sensor

Type	Appearance	Functions	Model	
			NPN output	PNP output
Pre-wired Models		ATC ATC error output	E3X-DA11AT-S	E3X-DA41AT-S
Connector Models		Alarm output	E3X-DA6AT-S	E3X-DA8AT-S

Separate Digital Amplifier Laser Sensors

Type	Appearance	Functions	Model	
			NPN output	PNP output
Pre-wired Models		ATC ATC error output	E3C-LDA11AT	E3C-LDA41AT
Connector Models		Alarm output	E3C-LDA6AT	E3C-LDA8AT

Ratings and Specifications

Item	Type	Model	Digital Fiber Sensors		Separate Digital Amplifier Laser Sensors	
		NPN output	E3X-DA11AT-S	E3X-DA6AT-S	E3C-LDA11AT	E3C-LDA6AT
		PNP output	E3X-DA41AT-S	E3X-DA8AT-S	E3C-LDA41AT	E3C-LDA8AT
Response time	Super-high-speed mode	Operate or Reset: 80 μ s			Operate or Reset: 100 μ s	
	High-speed mode	Operate or Reset: 250 μ s			Operate or Reset: 250 μ s	
	Standard mode	Operate or Reset: 1 ms				
	High-resolution mode	Operate or Reset: 4 ms				
Functions	ATC	Active threshold control (used for output 1)				
	I/O settings	The signal that is output can be selected (used for output 2): ATC error output				
	Startup operation	The operation when power is turned ON can be selected: No operation, PT, or PT + ATC				

Note: Basic performance is the same as the Advanced Twin-output Sensors. Refer to E3C-LDA Datasheet (E338) and E3X-DA-S Datasheet (E336) for details. Only differences from the Advanced Twin-output Sensors have been given above.

This document provides information mainly for selecting suitable models. Please read the *Instruction Sheet* carefully for information that the user must understand and accept before purchase, including information on warranty, limitations of liability, and precautions.

Note: Do not use this document to operate the Unit.

OMRON Corporation

Industrial Automation Company

Application Sensors Division
Sensing Devices and Components Division H.Q.

Shiokoji Horikawa, Shimogyo-ku,
Kyoto, 600-8530 Japan
Tel: (81)75-344-7068/Fax: (81)75-344-7107

Regional Headquarters

OMRON EUROPE B.V.

Sensor Business Unit,
Carl-Benz-Str. 4, D-71154 Nufringen,
Germany
Tel: (49)7032-811-0/Fax: (49)7032-811-199

OMRON ELECTRONICS LLC

1 East Commerce Drive, Schaumburg,
IL 60173 U.S.A.
Tel: (1)847-843-7900/Fax: (1)847-843-8568

OMRON ASIA PACIFIC PTE. LTD.

83 Clemenceau Avenue,
#11-01, UE Square,
239920 Singapore
Tel: (65)6835-3011/Fax: (65)6835-2711

OMRON CHINA CO., LTD. BEIJING OFFICE

Room 1028, Office Building,
Beijing Capital Times Square,
No. 88 West Chang'an Road,
Beijing, 100031 China
Tel: (86)10-8391-3005/Fax: (86)10-8391-3688

Authorized Distributor:

New Models That Eliminate Worries about Digital Sensor Setting Mistakes

Limited-function Models: Simple and Easy

- One-key, one-operation concept for easy operation.
- Threshold value setting with direct operation performed while monitoring the detection status.
- Lock function to prevent operating errors through unintentional operation.

Easy and Reliable Digital Sensors with the Same Detection Performance as Previous Models



Digital Fiber Sensors
E3X-DA□SE-S

Technology

The Simplest Digital Fiber Sensor

Some people think that digital sensors with their advanced performance are difficult to use, so we went back to the drawing board to rethink performance and functions.

Without changing basic functions like APC and digital displays, OMRON created a Digital Fiber Sensor that can be used as easily as the familiar sensors with sensitivity adjustment knobs.

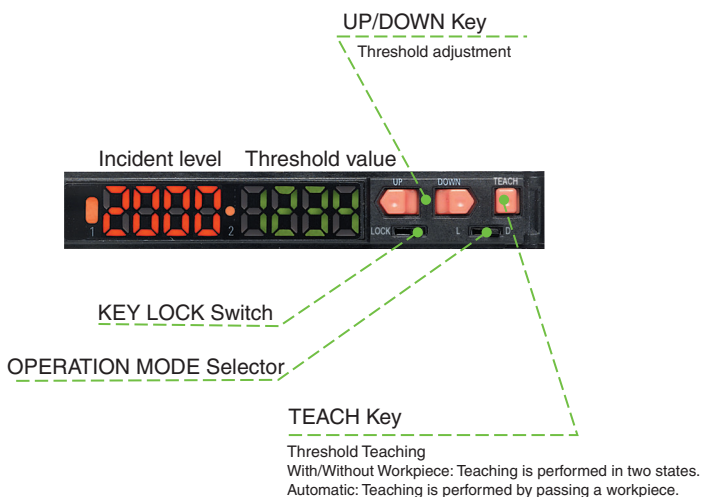



The *D_{IN}C* Engine for High-performance Sensing

OMRON's many years of accumulated sensing technology and high-speed digital processing techniques merge to meet onsite needs. Our goal is high-performance sensing that provides easy, reliable application.

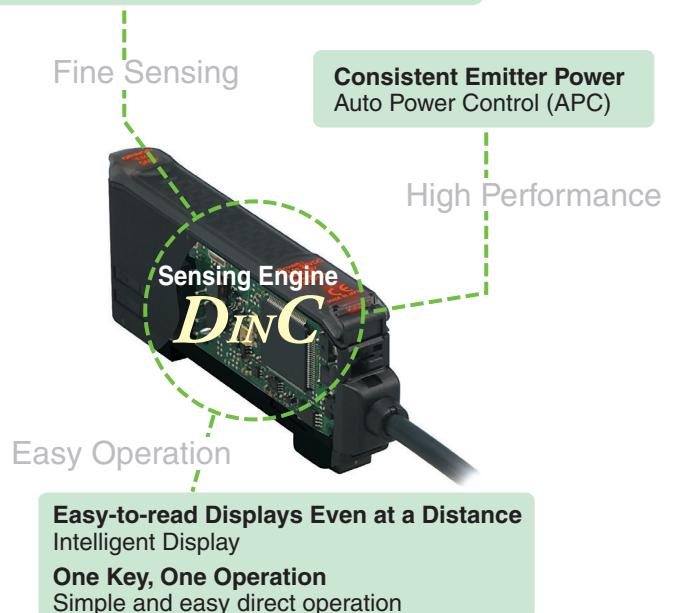
Reliable Detection of Small Workpieces
12-bit A/D converter (4,000 resolution)



Ordering Information

Type	Appearance	Model	
		NPN output	PNP output
Pre-wired Models		E3X-DA11SE-S	E3X-DA41SE-S
Connector Models		E3X-DA6SE-S	E3X-DA8SE-S

Ratings and Specifications

Item	Model		Digital Fiber Sensor
	Type	NPN output	E3X-DA11SE-S
	PNP output	E3X-DA41SE-S	E3X-DA6SE-S
Light source (wavelength)		Red LED (650 nm)	
Power supply voltage		12 to 24 VDC $\pm 10\%$, ripple (p-p): 10% max.	
Power consumption		960 mW max. (Power supply: 24 V, Current consumption: 40 mA max.)	
Control output		Load power supply: 26.4 VDC max., Open-collector output, Load current: 50 mA max. (Residual voltage: 1 V max.)	
Protection circuits		Power supply reverse polarity protection, Output short-circuit protection	
Response time		Operate or Reset: 1 ms	
Sensitivity setting		Teaching or manual adjustment	
Functions	Auto power control	High-speed control method for emission current	
	Mutual interference prevention	Optical communications sync, possible for up to 10 Units	
Indicators		Operation indicator (orange)	
Digital displays		Twin digital displays (incident level + threshold)	

Note: Basic performance is the same as the E3X-DA-S Series. Refer to the E3X-DA-S Datasheet (E336) for details.

This document provides information mainly for selecting suitable models. Please read the *Instruction Sheet* carefully for information that the user must understand and accept before purchase, including information on warranty, limitations of liability, and precautions.

Note: Do not use this document to operate the Unit.

OMRON Corporation

Industrial Automation Company

Application Sensors Division
Sensing Devices and Components Division H.Q.

Shiokoji Horikawa, Shimogyo-ku,
Kyoto, 600-8530 Japan
Tel: (81)75-344-7068/Fax: (81)75-344-7107

Regional Headquarters

OMRON EUROPE B.V.

Sensor Business Unit,
Carl-Benz-Str. 4, D-71154 Nufringen,
Germany
Tel: (49)7032-811-0/Fax: (49)7032-811-199

OMRON ELECTRONICS LLC

1 East Commerce Drive, Schaumburg,
IL 60173 U.S.A.
Tel: (1)847-843-7900/Fax: (1)847-843-8568

OMRON ASIA PACIFIC PTE. LTD.

83 Clemenceau Avenue,
#11-01, UE Square,
239920 Singapore
Tel: (65)6835-3011/Fax: (65)6835-2711

OMRON CHINA CO., LTD. BEIJING OFFICE

Room 1028, Office Building,
Beijing Capital Times Square,
No. 88 West Chang'an Road,
Beijing, 100031 China
Tel: (86)10-8391-3005/Fax: (86)10-8391-3688

Authorized Distributor:

Note: Specifications subject to change without notice.

OMRON's Next-generation Platform for a Wide Range of Detection

- Features a Power Tuning function that optimizes light reception at the press of a button.
- Combines newly developed 4-element LEDs with an APC circuit to ensure stable, long-term LED performance.
- Utilizes OMRON's innovative wire-saving connector.
- 2-channel models achieve the thinnest profile in the industry, at only 5 mm per channel.
- 2-channel models also offer AND/OR control output.



Be sure to read *Safety Precautions* on page 15.

Features

Equipped with an Industry's First Power Tuning (Optimum Light Setting) Function

The E3X-DA-S/MDA features a Power Tuning function that optimizes power at the press of a button. This function easily but securely resolves saturation due to short sensing distances or insufficient incident light due to long sensing distances. In addition, the response speed does not change as mode selection has tuned the power.

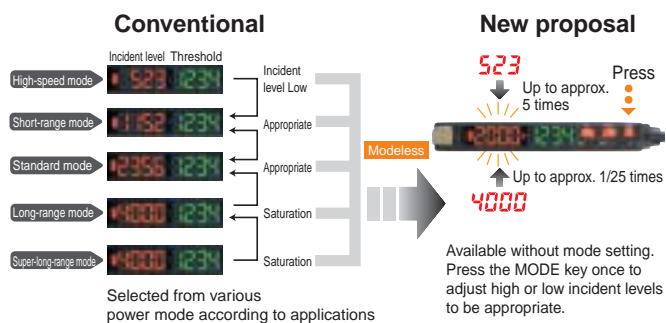

Adoption of Newly Developed 4-Element LEDs and an APC (Auto Power Control) Circuit Achieves Long-term Reliable Detection at the Highest Level in the Industry

The long-term reliable detection at the highest level in the industry is achieved with the innovative APC circuit whose performance is proved by E3X-DA-N series and the newly developed high-power LEDs (4-element type) to ensure super stable, long-term LED performance. Stable performance is always available without the ON/OFF setting of an APC circuit.

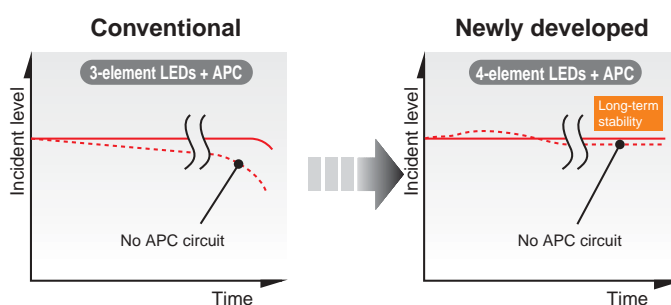

OMRON's Innovative Wire-saving Connector Inherited from the E3X-DA-N

The amplifier units with connectors supply the power to slave connectors via a master connector. This offers three following advantages.

1. Greatly reduced wiring work
2. Improved space usability due to the unnecessary of relay connectors
3. Simple stock management due to the unnecessary of distinction between master and slave for amplifiers

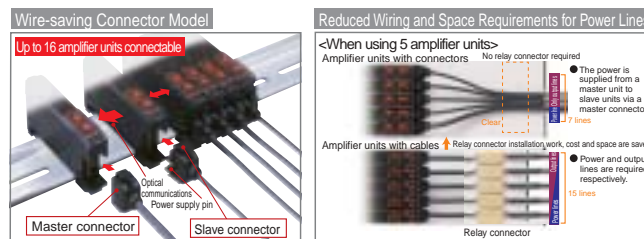

Models available for a wide variety of applications at manufacturing sites

Industry Leading Two Amplifiers Loaded in a Small Body 2-channel models

Two amplifiers are loaded in a 10 mm-wide body. Space usability can be approximately doubled. In addition, approximately 40% of the energy can be saved. (compared to the value per channel of the former model)

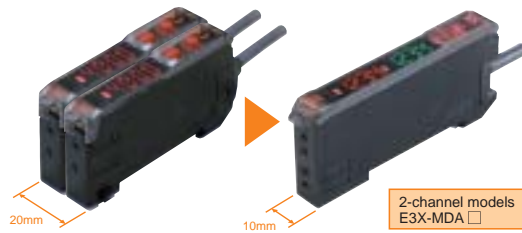

Simpler Digital Fiber Sensors Simple & Easy Single-function Models

Required performance and functions have been reviewed from basic points to improve high-performance but hard-to-use digital models. Digital fiber sensors, used in the sense as if using volume type sensors, are added to the basic functions such as an APC function and digital display.

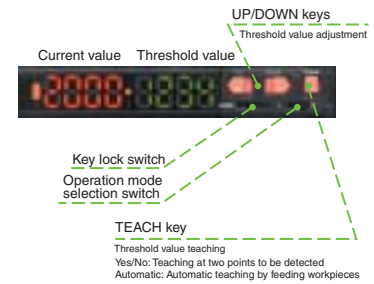

High-speed and High-resolution Analog Output Supports Wide Variety of Applications Advanced Analog Output Models

Analog Control Output

The voltage in the range of 1 to 5 V is output according to the incident level (digital display). Wide variety of applications is possible including positioning control or difference detection with multiple levels.

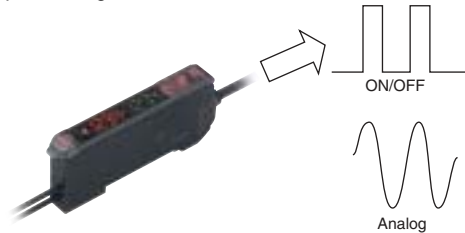

High-speed and High Resolution

Detection modes can be switched in accordance with applications. High-speed response of 80 μs (super-high-speed mode) supports the positioning controls that require high-speed control.

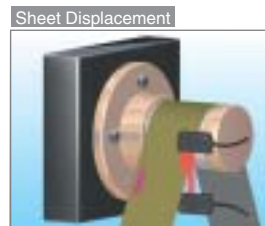

Area Output Function Area Judgment Is Possible Advanced, Twin-output Models

Only one sensor is enough for area judgment for height or others that has required multiple sensors. Setting two threshold values allows easy output inside and outside range.

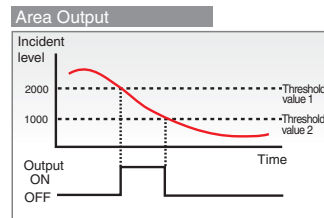

Remote Input Function Sensors Controlled from Outside Advanced, External-input Models

Remote settings for teaching/power tuning/light OFF are possible with input signals. The remote input function meets the diversifying demands such as remote settings made for frequent teaching due to level change corresponding to workpiece change or remote operation check of sensors before operation.



Equipped with an Industry's First ATC Function that Resolves Problems at Manufacturing Sites Advanced ATC Models

OMRON's unique algorithm is equipped to distinguish dust or dirt and the change of workpieces. Automatic correction of threshold values by sensors in accordance with changes prevents malfunctions and improves the operating rates of machines. The ATC function is especially effective for the applications that require high-resolution detection.

Fixed Threshold Value Method (Conventional Models)

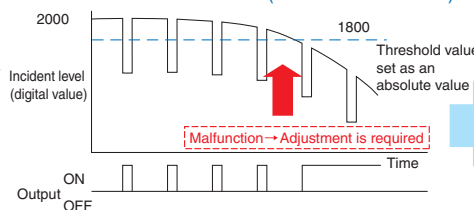

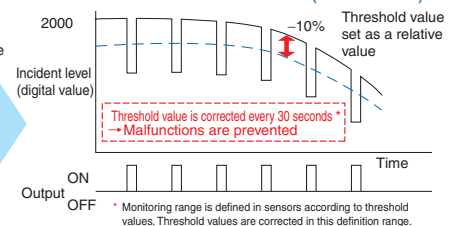

Corrected Threshold Value Method (ATC Models)





Ordering Information

Amplifier Units

Amplifier Units with Cables (2 m) [Refer to *Dimensions* on page 17.]

Item		Appearance	Functions	Model	
				NPN output	PNP output
Single-function models			---	E3X-DA11SE-S 2M	E3X-DA41SE-S 2M
Standard models			Timer, Response speed change	E3X-DA11-S 2M	E3X-DA41-S 2M
Mark-detecting models (multiple color light sources)	Green LED			E3X-DAG11-S 2M	E3X-DAG41-S 2M
	Blue LED			E3X-DAB11-S 2M	E3X-DAB41-S 2M
	Infrared LED			E3X-DAH11-S 2M	E3X-DAH41-S 2M
Advanced models	External-input models		Remote setting, counter, differential operation	E3X-DA11RM-S 2M	E3X-DA41RM-S 2M
	Twin-output models		Area output, self-diagnosis, differential operation	E3X-DA11TW-S 2M	E3X-DA41TW-S 2M
	ATC function models		ATC (Threshold value automatic correction)	E3X-DA11AT-S 2M	E3X-DA41AT-S 2M
	Analog output models		Analog output models	E3X-DA11AN-S 2M	E3X-DA41AN-S 2M
2-channel models				AND/OR output	E3X-MDA11 2M

Amplifier Units with Connectors

Item		Appearance	Functions	Model		
				NPN output	PNP output	
Single-function models			---	E3X-DA6SE-S	E3X-DA8SE-S	
Standard models			Timer, Response speed change	E3X-DA6-S	E3X-DA8-S	
Mark-detecting models (multiple color light sources)	Green LED			E3X-DAG6-S	E3X-DAG8-S	
	Blue LED			E3X-DAB6-S	E3X-DAB8-S	
	Infrared LED			E3X-DAH6-S	E3X-DAH8-S	
Advanced models	External-input models		Remote setting, counter, differential operation	E3X-DA6RM-S	E3X-DA8RM-S	
	Twin-output models		Area output, self-diagnosis, differential operation	E3X-DA6TW-S	E3X-DA8TW-S	
	ATC function models		ATC (Threshold value automatic correction)	E3X-DA6AT-S	E3X-DA8AT-S	
2-channel models				AND/OR output	E3X-MDA6	E3X-MDA8

Ratings and Specifications

		Light source	Response time	Control output/input			Functions					
				ON/OFF output	Input	Analog output	Power tuning	Timer	Interference prevention	Differential detection	counter	ATC
Single-function models		Red LED	1 ms	Only main	---	---	---	---	○	---	---	---
Standard models			50 μs to 4 ms									
Mark-detecting models	E3X-DA□G-S	Green LED	50 μs to 4 ms	Only main	---	---	○	○	○	---	---	---
	3X-DA□B-S	Blue LED										
	E3X-DA□H-S	Infrared LED										
Advanced models	Twin-output models	Red LED	50 μs to 4 ms	Only main	○ (1 line)	---	○	○	○	○	---	○
	External-input models		80 μs to 4 ms									
	ATC function models		130 μs to 4 ms	Only main	○ (1 line)	○	○	○	---	○		
	Analog output		80 μs to 4 ms									
2-channel models		Red LED	130 μs to 4 ms	Main + main (2 independent lines)	---	---	○	○	○	---	---	---

Amplifier Unit Connectors (Order Separately)

Note: Protector seals are provided as accessories. [\[Refer to Dimensions on page 19.\]](#)

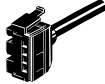
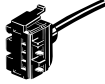
Item	Appearance	Cable length	No. of conductors	Model
Master Connector		2 m	3	E3X-CN11
			4	E3X-CN21
Slave Connector			1	E3X-CN12
			2	E3X-CN22

Combining Amplifier Units and Connectors





Amplifier Units and Connectors are sold separately. Refer to the following tables when placing an order.

Amplifier Unit			Applicable Connector (Order Separately)	
Model	NPN output	PNP output	Master Connector	Slave Connector
Single-function models	E3X-DA6SE-S	E3X-DA8SE-S	E3X-CN11	E3X-CN12
Standard models	E3X-DA6-S	E3X-DA8-S		
Mark-detecting models (multiple color light sources)	E3X-DAG6-S	E3X-DAG8-S		
	E3X-DAB6-S	E3X-DAB8-S		
	E3X-DAH6-S	E3X-DAH8-S		
Advanced models	E3X-DA6TW-S	E3X-DA8TW-S	E3X-CN21	E3X-CN22
	E3X-DA6RM-S	E3X-DA8RM-S		
	E3X-DA6AT-S	E3X-DA8AT-S		
2-channel models	E3X-MDA6	E3X-MDA8		

When Using 5 Amplifier Units

Amplifier Units (5 Units)	+	1 Master Connector + 4 Slave Connectors
---------------------------	---	---

Mobile Console (Order Separately) [\[Refer to Dimensions on page 20.\]](#)

Appearance	Model	Remarks
	E3X-MC11-SV2 (model number of set)	Mobile Console with Head, Cable, and AC adapter provided as accessories
	E3X-MC11-C1-SV2	Mobile Console
	E3X-MC11-H1	Head
	E39-Z12-1	Cable (1.5 m)

Note: Use the E3X-MC11-SV2 Mobile Console for the E3X-DA-S/MDA-series Amplifier Units.

The E3X-MC11-SV2 is an upgraded version of the E3X-MC11-S that is fully interchangeable with the older model.

Accessories (Order Separately)

Mounting Bracket [\[Refer to E39-L/F39-L/E39-S/E39-R.\]](#)

Appearance	Model	Quantity
	E39-L143	1

End Plate [\[Refer to PFP-□.\]](#)

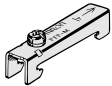
Appearance	Model	Quantity
	PFP-M	1

Ratings and Specifications

Refer to pages 17 to 20 for dimensions.

Amplifier Units

Item	Type	Single-function models E3X-DA□SE-S	Standard models E3X-DA□-S	Mark-detecting models (multiple color light sources)		
	Model			Green LED	Blue LED	Infrared LED
				E3X-DAG□-S	E3X-DAB□-S	E3X-DAH□-S
Light source (wavelength)		Red LED (635 nm)		Green LED (525 nm)	Blue LED (470 nm)	Infrared LED (870nm)
Power supply voltage		12 to 24 VDC ±10%, ripple (p-p) 10% max.				
Power consumption		960 mW max. (current consumption: 40 mA max. at power supply voltage of 24 VDC)				
Control output		Load power supply voltage: 26.4 VDC; NPN/PNP open collector; load current: 50 mA max.; residual voltage: 1 V max.				
Protection circuits		Reverse polarity for power supply connection, output short-circuit				
Re-sponse time	Super-high-speed mode	---	Operate: 48 μs, reset: 50 μs *1, *2			
	High-speed mode	---	Operate/reset: 250 μs			
	Standard mode	Operate or reset: 1 ms				
	High-resolution mode	---	Operate or reset: 4 ms			
Sensitivity setting		Teaching or manual method				
Func-tions	Power tuning	---	Light emission power and reception gain, digital control method			
	Timer function	---	Select from OFF-delay, ON-delay, or one-shot timer. 1 ms to 5 s (1 to 20 ms set in 1-ms increments, 20 to 200 ms set in 10-ms increments, 200 ms to 1 s set in 100-ms increments, and 1 to 5 s set in 1 s-increments)			
	Automatic power control (APC)	High-speed control method for emission current				
	Zero-reset	---	Negative values can be displayed. (Threshold value is shifted.)			
	Initial reset	Settings can be returned to defaults as required.				
	Mutual interference prevention	Possible for up to 10 Units *3				
Display		Operation indicator (orange)	Operation indicator (orange), Power Tuning indicator (orange)			
Digital display		incident level + threshold	Select from incident level + threshold or other 6 patterns			
Display orientation		---	Switching between normal/reversed display is possible.			
Ambient illumination (Receiver side)		Incandescent lamp: 10,000 lux max. Sunlight: 20,000 lux max.				
Ambient temperature range		Operating: Groups of 1 to 2 Amplifiers: -25°C to 55°C Groups of 3 to 10 Amplifiers: -25°C to 50°C Groups of 11 to 16 Amplifiers: -25°C to 45°C Storage: -30°C to 70°C (with no icing or condensation)				
Ambient humidity range		Operating and storage: 35% to 85% (with no condensation)				
Insulation resistance		20 MΩ min. (at 500 VDC)				
Dielectric strength		1,000 VAC at 50/60 Hz for 1 minute				
Vibration resistance		Destruction: 10 to 55 Hz with a 1.5-mm double amplitude for 2 hrs each in X, Y and Z directions				
Shock resistance		Destruction: 500 m/s ² , for 3 times each in X, Y and Z directions				
Degree of protection		IEC 60529 IP50 (with Protective Cover attached)				
Connection method		Pre-wired or amplifier unit connector				
Weight (packed state)		Pre-wired model: Approx. 100 g, Amplifier unit connector model: Approx. 55 g				
Materials	Case	Polybutylene terephthalate (PBT)				
	Cover	Polycarbonate (PC)				
Accessories		Instruction manual				

*1. Communications are disabled if the detection mode is selected during super-high-speed mode, and the communications functions for mutual interference prevention and the Mobile Console will not function.

*2. PNP output is as follows: Operate: 53 μs, reset: 55 μs.

*3. Mutual interference prevention can be used for only up to 6 Units if power tuning is enabled.

Item	Type Model	Advanced models				2-channel models E3X-MDA□
		External input mod-els E3X-DA□RM-S	Twin output mod-els E3X-DA□TW-S	ATC function mod-els E3X-DA□AT-S	Analog output mod-els E3X-DA□AN-S	
Light source (wavelength)	Red LED (635 nm)					
Power supply voltage	12 to 24 VDC ±10%, ripple (p-p) 10% max.					
Power consumption	1,080 mW max. (current consumption: 45 mA max. at power supply voltage of 24 VDC)					
Control output	ON/OFF output	Load power supply voltage: 26.4 VDC; NPN/PNP open collector; load current: 50 mA max.; residual voltage: 1 V max.				
	Analog output	---	---	---	Control output Voltage output: 1 to 5 VDC (Connection load 10 kΩ min.) Temperature characteristics 0.3%F.S./°C Response speed/repeat accuracy Super-high-speed mode: 80 μs/1.5%F.S. High-speed mode: 250 μs/1.5%F.S. Standard mode: 1 ms/1%F.S. High-resolution mode: 4 ms/0.75%F.S.	
Remote control input	No-voltage input (contact/non-contact) *1					
Protection circuits	Reverse polarity for power supply connection, output short-circuit					
Re-sponse time	Super-high-speed mode	Operate: 48 μs, reset: 50 μs *2, *3, *4	Operate or reset: 80 μs *2	Operate or reset: 130 μs *2	Operate or reset: 80 μs *2	Operate or reset: 130 μs *2, *5
	High-speed mode	Operate or reset: 250 μs				Operate or reset: 450 μs
	Standard mode	Operate or reset: 1ms				
	High-resolution mode	Operate or reset: 4ms				
Sensitivity setting	Teaching or manual method					
Func-tions	Power tuning	Light emission power and reception gain, digital control method				
	Differential de-tection	Switchable between single edge and double edge detection mode Single edge: Can be set to 250 μs, 500 μs, 1 ms, 10 ms, or 100 ms. Double edge: Can be set to 500 μs, 1 ms, 2 ms, 20 ms, or 200 ms.			---	
	Timer function	Select from OFF-delay, ON-delay, or one-shot timer. 1 ms to 5 s (1 to 20 ms set in 1-ms increments, 20 to 200 ms set in 10-ms increments, 200 ms to 1 s set in 100-ms increments, and 1 to 5 s set in 1 s-increments)				
	Automatic pow-er control (APC)	High-speed control method for emission current				
	Zero-reset	Negative values can be displayed. (Threshold value is shifted.)				
	Initial reset	Settings can be returned to defaults as required.				
	Mutual inter-ference prevention	Possible for up to 10 Units *6				Possible for up to 9 Units (18 channels) *7
Counter	Switchable between up counter and down counter. Set count: 0 to 9,999,999	---				

*1. Input Specifications

	Contact input (relay or switch)	Non-contact input (transistor)
NPN	ON: Shorted to 0 V (sourcing current: 1 mA max.). OFF: Open or shorted to Vcc.	ON: 1.5 V max. (sourcing current: 1 mA max.) OFF: Vcc - 1.5 V to Vcc (leakage current: 0.1 mA max.)
PNP	ON: Shorted to Vcc (sinking current: 3 mA max.). OFF: Open or shorted to 0 V.	ON: Vcc - 1.5 V to Vcc (sinking current: 3 mA max.) OFF: 1.5 V max. (leakage current: 0.1 mA max.)

*2. Communications are disabled if the detection mode is selected during super-high-speed mode, and the communications functions for mutual interference prevention and the Mobile Console will not function.

*3. PNP output is as follows: Operate: 53 μs, reset: 55 μs.

*4. When counter is enabled: 80 μs for operate and reset respectively.

*5. When differential output is selected for the output setting, the second channel output is 200 μs for operation and reset respectively.

*6. Mutual interference prevention can be used for only up to 6 Units if power tuning is enabled.

*7. Mutual interference prevention can be used for up to 5 Units (10 channels) if power tuning is enabled.

Type		Advanced models				2-channel models
		External input models	Twin-output models	ATC function models	Analog output models	
Item	Model	E3X-DA□RM-S	E3X-DA□TW-S	E3X-DA□AT-S	E3X-DA□AN-S	E3X-MDA□
Functions	I/O setting	External input setting (Select from teaching, power tuning, zero reset, light OFF, or counter reset.)	Output setting (Select from channel 2 output, area output, or self-diagnosis.)	Output setting (Select from channel 2 output, area output, self-diagnosis output, or ATC error output)	Analog output setting (offset voltage adjustable)	Output setting (Select from channel 2 output, AND, OR, leading edge sync, falling edge sync, or differential output)
Display		Operation indicator (orange), Power Tuning indicator (orange)	Operation indicator for channel 1 (orange), Operation indicator for channel 2 (orange)		Operation indicator (orange), Power Tuning indicator (orange)	Operation indicator for channel 1 (orange), Operation indicator for channel 2 (orange)
Digital display		Select from incident level + threshold or other 7 patterns	Select from incident level + threshold or other 6 patterns			Select from incident level for channel 1 + incident level for channel 2 or other 7 patterns
Display orientation		Switching between normal/reversed display is possible.				
Ambient illumination (Receiver side)		Incandescent lamp: 10,000 lux max. Sunlight: 20,000 lux max.				
Ambient temperature range		Operating: Groups of 1 to 2 Amplifiers: -25°C to 55°C Groups of 3 to 10 Amplifiers: -25°C to 50°C Groups of 11 to 16 Amplifiers: -25°C to 45°C Storage: -30°C to 70°C (with no icing or condensation)				
Ambient humidity range		Operating and storage: 35% to 85% (with no condensation)				
Insulation resistance		20 MΩ min. (at 500 VDC)				
Dielectric strength		1,000 VAC at 50/60 Hz for 1 minute				
Vibration resistance		Destruction: 10 to 55 Hz with a 1.5-mm double amplitude for 2 hrs each in X, Y and Z directions				
Shock resistance		Destruction: 500 m/s ² , for 3 times each in X, Y and Z directions				
Degree of protection		IEC 60529 IP50 (with Protective Cover attached)				
Connection method		Pre-wired or amplifier unit connector				
Weight (packed state)		Pre-wired model: Approx. 100 g, Amplifier unit connector model: Approx. 55 g				
Materials	Case	Polybutylene terephthalate (PBT)				
	Cover	Polycarbonate (PC)				
Accessories		Instruction manual				

Amplifier Unit Connectors

Item	Model	E3X-CN11/21/22	E3X-CN12
Rated current		2.5 A	
Rated voltage		50 V	
Contact resistance		20 mΩ max. (20 mVDC max., 100 mA max.) (The figure is for connection to the Amplifier Unit and the adjacent Connector. It does not include the conductor resistance of the cable.)	
No. of insertions		Destruction: 50 times (The figure for the number of insertions is for connection to the Amplifier Unit and the adjacent Connector.)	
Materials	Housing	Polybutylene terephthalate (PBT)	
	Contacts	Phosphor bronze/gold-plated nickel	
Weight (packed state)		Approx. 55 g	Approx. 25 g

Mobile Console

Item	Model	E3X-MC11-SV2
Applicable Sensors		E3X-DA-S E3X-MDA E3C-LDA E2C-EDA
Power supply voltage		Charged with AC adapter
Connection method		Connected via adapter
Weight (packed state)		Approx. 580 g (Console only: 120 g)

Refer to *Instruction Manual* provided with the Mobile Console for details.

Sensing Distance Through-beam Models

(Unit: mm)

Type		Model	E3X-DA□-S				E3X-MDA□			
			High-resolution mode	Standard mode	High-speed mode	Super-high-speed mode	High-resolution mode	Standard mode	High-speed mode	Super-high-speed mode
Standard models	Flexible (new standard)	E32-T11R/E32-T12R/E32-T15XR/E32-TC200BR(B4R)	700	530	350	140	450	350	230	140
		E32-T14LR/E32-T15YR/E32-T15ZR	270	210	130	50	170	130	85	50
		E32-T21R/E32-T22R/E32-T222R/E32-T25XR/E32-TC200FR(F4R)	160	130	75	30	100	75	50	30
		E32-T24R/E32-T25YR/E32-T25ZR	60	50	25	10	35	27	18	10
	Standard	E32-TC200/E32-T12/E32-T15X/E32-TC200B(B4)	1,000	760	500	200	650	500	330	200
		E32-T14L/E32-T15Y/E32-T15Z	600	460	300	120	390	300	200	120
		E32-TC200A	900	680	450	180	580	450	300	180
		E32-TC200E/E32-T22/E32-T222/E32-T25X/E32-TC200F(F4)	270	220	125	50	170	130	85	50
	Break-resistant	E32-T24/E32-T25Y/E32-T25Z	160	130	75	30	100	70	45	30
		E32-T11/E32-T12B/E32-T15XB	900	680	450	180	580	450	300	180
		E32-T21/E32-T221B/E32-T22B	240	200	110	45	150	110	70	45
	Fluorine coating	E32-T25XB	180	150	85	35	125	95	60	35
		E32-T11U	900	680	450	180	580	450	300	180
Special-beam models	Long-distance, high power	E32-T17L	20,000*1	20,000*1	10,000	4,000	13,000	10,000	6,500	4,000
		E32-TC200 + E39-F1	4,000*2	4,000*2	2,600	1,500	4,000	3,700	2,400	1,500
		E32-T11R + E39-F1	4,000*2	3,700	2,400	970	3,100	2,400	1,600	970
		E32-T11 + E39-F1	4,000*2	3,600	2,300	930	3,000	2,300	1,500	930
		E32-T14	4,000*2	3,400	2,250	900	2,900	2,200	1,450	900
		E32-T11L/E32-T12L	1,700	1,330	870	350	1,100	870	580	350
		E32-T11L + E39-F2	910	800	500	180	600	520	340	180
		E32-T11R + E39-F2	520	400	250	100	330	260	170	100
		E32-T11 + E39-F2	820	660	430	160	530	430	280	160
		E32-T21L/E32-T22L	540	440	250	100	340	260	170	100
	Ultracompact, ultrafine sleeve	E32-T223R	160	130	75	30	110	85	55	30
		E32-T33-S5	53	44	25	10	35	28	18	10
		E32-T333-S5	12	10	6	4	8	6	5	4
		E32-T334-S5	6	5	3	2	4	3	2	2
	Fine beam	E32-T22S	2,500	1,900	1,250	500	1,600	1,250	830	500
		E32-T24S	1,750	1,300	870	350	1,100	870	580	350
	Area sensing	E32-T16PR	1,100	840	560	220	730	560	370	220
		E32-T16P	1,500	1,100	750	300	970	750	500	300
		E32-T16JR	980	750	480	190	600	480	320	190
		E32-T16J	1,300	1,000	650	260	800	650	430	260
		E32-T16WR	1,700	1,300	850	340	1,100	860	570	340
		E32-T16W	2,300	1,800	1,150	450	1,400	1,100	730	450
		E32-T16	3,700	2,800	1,850	740	2,400	1,800	1,200	740
	E32-M21	750	610	350	140	470	360	240	140	

*1. The optical fiber for the E32-T17L is 10 m long on each side, so the value is 20,000 mm

*2. The optical fiber is 2 m long on each side, so the sensing distance is 4,000 mm.

Type			Model	E3X-DA□-S				E3X-MDA□			
				High-resolution mode	Standard mode	High-speed mode	Super-high-speed mode	High-resolution mode	Standard mode	High-speed mode	Super-high-speed mode
Environment resistant models	Heat-resistant	E32-T51	1,000	760	500	200	650	500	330	200	
		E32-T54	300	230	150	60	190	150	100	60	
		E32-T81R-S	360	280	180	70	230	180	120	70	
		E32-T61-S + E39-F2	600	450	300	120	390	300	200	120	
		E32-T61-S + E39-F1	4,000	3,400	2,200	900	3,000	2,200	1,450	900	
		E32-T84S-S	1,750	1,300	870	350	1,100	870	570	350	
	E32-T61-S	600	450	300	120	390	300	200	120		
	Chemical resistant	E32-T11F	2,500	2,000	1,300	520	1,600	1,300	850	520	
		E32-T12F	4,000*	3,000	2,000	800	2,600	2,000	1,300	800	
		E32-T14F	500	400	250	100	320	250	160	100	
		E32-T51F	1,800	1,400	900	350	1,190	920	600	350	
		E32-T81F-S	920	700	460	190	600	460	300	190	
	Vacuum resistant	E32-T51V	260	200	130	50	170	130	85	50	
		E32-T51V + E39-F1V	1,350	1,000	680	260	850	650	430	260	
		E32-T54V	210	130	100	35	110	85	55	35	
		E32-T54V + E39-F1V	660	500	330	180	420	320	210	180	
E32-T84SV		630	480	320	130	410	310	200	130		

* The optical fiber for the E32-T12F is 2 m long on each side, so the sensing distance is 4,000 mm.

Reflective Models

(Unit: mm)

Type			Model	E3X-DA□-S				E3X-MDA□			
				High-resolution mode	Standard mode	High-speed mode	Super-high-speed mode	High-resolution mode	Standard mode	High-speed mode	Super-high-speed mode
Standard models	Flexible (new standard)	E32-D11R/E32-D12R/E32-D15XR/E32-DC200BR(B4R)	300	170	120	50	170	120	80	50	
		E32-D14LR	80	45	30	14	45	33	22	14	
		E32-D15YR/E32-D15ZR	70	40	26	12	40	29	19	12	
		E32-D211R/E32-D21R/E32-D22R/E32-D25XR/E32-DC200FR(F4R)	50	30	20	8	30	22	14	8	
		E32-D24R	26	15	10	4	15	10	6	4	
		E32-D25YR/E32-D25ZR	14	8	5	2	8	5	3.3	2	
	Standard	E32-DC200/E32-D15X/E32-DC200B(B4)	500	300	200	90	300	210	130	90	
		E32-D12	400	230	160	70	230	160	100	70	
		E32-D14L	200	110	80	36	110	80	50	36	
		E32-D15Y/E32-D15Z	170	100	65	30	100	70	45	30	
		E32-D211/E32-DC200E/E32-D22/E32-D25X/E32-DC200F(F4)	130	80	50	22	80	55	35	22	
		E32-D24	50	30	20	8	30	22	14	8	
		E32-D25Y/E32-D25Z	35	20	12	6	20	14	9	6	
	Break-resistant	E32-D11/E32-D15XB	300	170	120	50	170	125	80	50	
		E32-D21B/E32-D221B	110	70	45	20	70	50	30	20	
		E32-D21/E32-D22B	50	30	20	8	30	22	14	8	
		E32-D25XB	85	50	30	15	50	35	23	15	
	Fluorine coating	E32-D11U	300	170	120	50	170	125	80	50	

Type			Model	E3X-DA□-S				E3X-MDA□			
				High-resolution mode	Standard mode	High-speed mode	Super-high-speed mode	High-resolution mode	Standard mode	High-speed mode	Super-high-speed mode
Special-beam models	Long distance, high power	E32-D16	40 to 1,000	40 to 700	40 to 450	40 to 240	40 to 600	40 to 490	40 to 300	40 to 240	
		E32-D11L	650	400	260	110	400	270	180	110	
		E32-D21L/E32-D22L	210	130	80	35	130	85	55	35	
	Ultracompact, ultrafine sleeve	E32-D33	25	16	10	4	16	10	6	4	
		E32-D331	5	3	2	0.8	3	2	1.3	0.8	
	Coaxial/small spot	E32-CC200R	250	150	100	45	150	105	65	45	
		E32-CC200	500	300	200	90	300	210	140	90	
		E32-D32L	250	150	100	45	150	100	65	45	
		E32-C31/E32-D32	120	75	50	22	75	50	30	22	
		E32-C42 + E39-F3A	Spot diameter variable in the range 0.1 to 0.6 mm at distances in the range 6 to 15 mm.								
		E32-D32 + E39-F3A	Spot diameter variable in the range 0.5 to 1mm at distances in the range 6 to 15 mm.								
		E32-C41 + E39-F3A-5	0.1-mm dia. spot at a distance of 7 mm.								
		E32-C31 + E39-F3A-5	0.5-mm dia. spot at a distance of 7 mm.								
		E32-C41 + E39-F3B	0.2-mm dia. spot at a distance of 17 mm.								
		E32-C31 + E39-F3B	0.5-mm dia. spot at a distance of 17 mm.								
	E32-C31 + E39-F3C	Spot diameter of 4 mm max. at distances in the range 0 to 20 mm.									
	Area sensing	E32-D36P1	250	150	100	45	150	100	65	45	
	Retroreflective	E32-R21 + E39-R3 (provided)	10 to 250								
		E32-R16 + E39-R1 (provided)	150 to 1,500								
	Convergent-reflective	E32-L25/E32-L25A	3.3								
		E32-L24S	0 to 4								
		E32-L24L	2 to 6 (center 4)								
		E32-L25L	5.4 to 9 (center 7.2)								
E32-L86		4 to 10									
Environment-resistant models	Heat-resistant	E32-D51	400	230	160	72	230	165	110	72	
		E32-D81R-S E32-D61-S	150	90	60	27	90	63	40	27	
		E32-D73-S	100	60	40	18	60	40	25	18	
	Chemical-resistant	E32-D12F	160	95	65	30	95	70	45	30	
		E32-D14F	70	40	30	10	40	28	18	10	

Application-specific Models

(Unit: mm)

Type		Model	E3X-DA□-S				E3X-MDA□				
			High-resolution mode	Standard mode	High-speed mode	Super-high-speed mode	High-resolution mode	Standard mode	High-speed mode	Super-high-speed mode	
Application-specific models	Label detection	E32-G14	10								
		E32-T14	4,000*	3,400	2,250	900	2,900	2,200	1,450	900	
	Liquid-level detection	E32-L25T	Applicable tube: Transparent tube with a diameter in the range 8 to 10 mm and a recommended wall thickness of 1 mm								
		E32-D36T	Applicable tube: Transparent tube (no restriction on diameter)								
		E32-A01	Applicable tube: Transparent tube with a diameter of 3.2, 6.4, or 9.5 mm and a recommended wall thickness of 1 mm								
		E32-A02	Applicable tube: Transparent tube with a diameter in the range 6 to 13 mm and a recommended wall thickness of 1 mm								
		E32-D82F1(F2)	Liquid-contact model								
	Glass-substrate alignment	E32-L16-N	0 to 15		0 to 12		0 to 15		0 to 12		
		E32-A08	10 to 20		---		10 to 20		---		
		E32-A07E1(E2)	15 to 25		---		15 to 25		---		
		E32-L66	5 to 18	5 to 16	---		5 to 18	5 to 14	---		
	Glass-substrate Mapping	E32-A09/E32-A09H	15 to 38		---		15 to 38		---		
		E32-A09H2	20 to 30		---		20 to 30		---		
	Wafer mapping	E32-A03/E32-A03-1	1,150	890	600	250	750	580	380	250	
		E32-T24S	1,750	1,300	870	350	1,100	870	580	350	
		E32-A04/E32-A04-1	460	340	225	100	300	220	145	100	

* The optical fiber for the E32-T14 is 2 m long on each side, so the sensing distance is 4,000 mm.

Green, Blue, and Infrared Light Sources

(Unit: mm)

Type			Model	E3X-DAG□-S/DAB□-S				E3X-DAH□-S			
				High-resolution mode	Standard mode	High-speed mode	Super-high-speed mode	High-resolution mode	Standard mode	High-speed mode	Super-high-speed mode
Through-beam models	Standard	E32-T11R/E32-T12R/E32-T15XR/E32-TC200BR(B4R)	65	50	35	30	280	190	130	55	
		E32-T14LR/E32-T15YR/E32-T15ZR	25	20	22	12	100	75	80	21	
		E32-TC200/E32-T12/E32-T15X/E32-TC200B(B4)	100	75	50	45	400	280	180	80	
		E32-T14L/E32-T15Y/E32-T15Z	50	40	30	25	240	160	110	45	
	Special beam	E32-T11L/E32-T12L	150	120	85	75	700	490	320	140	
Reflective models	Standard	E32-D11R/E32-D12R/E32-D15XR/E32-DC200BR(B4R)	17	14	10	8	120	90	60	21	
		E32-D14LR	4.4	3.5	2.5	2.2	32	24	16	5.5	
		E32-D15YR/E32-D15ZR	4.2	3.3	2.2	2.1	28	20	13	5	
		E32-DC200/E32-D15X/E32-DC200B(B4)	32	25	16	16	200	150	100	35	
		E32-D14L	11	9	6	5.5	80	60	40	14	
		E32-D15Y/E32-D15Z	10	8	5.5	5	65	50	33	11	
	Special beam	E32-D11L	44	35	22	22	260	190	130	45	
		E32-CC200R	15	12	8	7.5	100	75	50	17	
		E32-CC200	32	25	16	16	200	150	100	35	
		E32-D32L	15	12	8	7.5	100	75	50	17	
		E32-C31/E32-D32	7.5	6	4	3.5	50	37	25	8.5	
Application-specific models	Label detection	E32-T14	320	260	220	160	1,800	1,200	820	360	
		E32-G14	10				10				

Refer to E32 Series for details on Fiber Units.

Output Circuit Diagrams

NPN Output

Model	Operation mode	Timing charts	Operation selector	Output circuit
E3X-DA11-S E3X-DA6-S E3X-DAG11-S E3X-DAG6-S E3X-DAB11-S E3X-DAB6-S E3X-DA11SE-S E3X-DA6SE-S	Light-ON		LIGHT ON (L-ON)	
	Dark-ON		DARK ON (D-ON)	
E3X-DA11TW-S E3X-DA6TW-S E3X-MDA11 E3X-MDA6 E3X-DA11AT-S E3X-DA6AT-S	Light-ON		LIGHT ON (L-ON)	
	Dark-ON		DARK ON (D-ON)	
E3X-DA11RM-S E3X-DA6RM-S	Light-ON		LIGHT ON (L-ON)	
	Dark-ON		DARK ON (D-ON)	
E3X-DA11AN-S	Light-ON		LIGHT ON (L-ON)	
	Dark-ON		DARK ON (D-ON)	

Note: 1. The ON/OFF regions when areas settings are used with the E3X-DA□TW-S are as follows:
 LIGHT ON: ON when the incident level is between the thresholds for channels 1 and 2.
 DARK ON: OFF when the incident level is between the thresholds for channels 1 and 2.

2. Timing Charts for Timer Function Settings (T: Set Time)

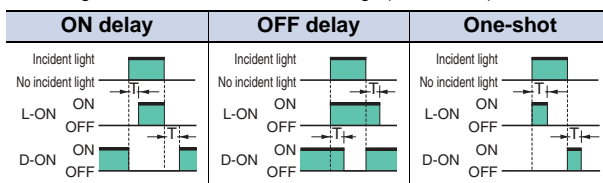

3. Control Output (AND, OR, Sync) and Timing Chart for Timer Settings (T: Set Time)

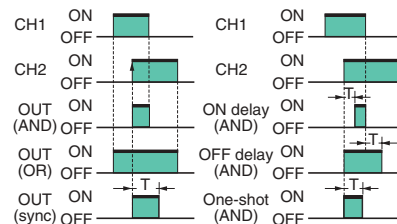

PNP Output

Model	Operation mode	Timing chart	Operation selector	Output circuit
E3X-DA41-S E3X-DA8-S E3X-DAG41-S E3X-DAG8-S E3X-DAB41-S E3X-DAB8-S E3X-DA41SE-S E3X-DA8SE-S	Light-ON		LIGHT ON (L-ON)	
	Dark-ON		DARK ON (D-ON)	
E3X-DA41TW-S E3X-DA8TW-S E3X-MDA41 E3X-DA41AT-S E3X-DA8AT-S	Light-ON		LIGHT ON (L-ON)	
	Dark-ON		DARK ON (D-ON)	
E3X-DA41RM-S E3X-DA8RM-S	Light-ON		LIGHT ON (L-ON)	
	Dark-ON		DARK ON (D-ON)	
E3X-DA41AN-S	Light-ON		LIGHT ON (L-ON)	
	Dark-ON		DARK ON (D-ON)	

Note: The ON/OFF regions when areas settings are used with the E3X-DA□TW-S are as follows:
 LIGHT ON: ON when the incident level is between the thresholds for channels 1 and 2.
 DARK ON: OFF when the incident level is between the thresholds for channels 1 and 2.

Nomenclature

Amplifier Units

E3X-DA□-S

E3X-DA□RM-S

E3X-DA□AN-S

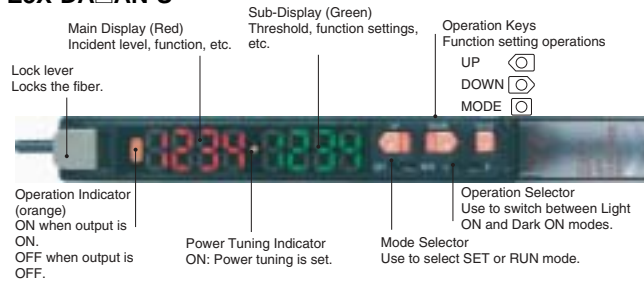

E3X-DA□TW-S

E3X-DA□AT-S

E3X-MDA□

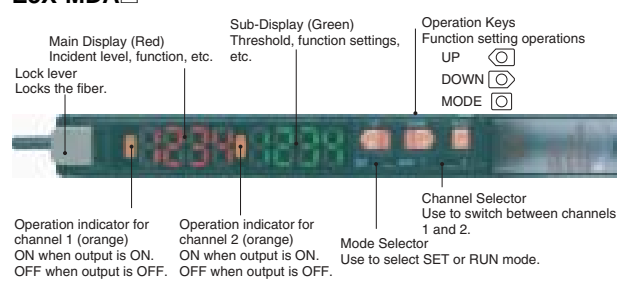

Safety Precautions

Refer to *Warranty and Limitations of Liability*.

WARNING

This product is not designed or rated for ensuring safety of persons either directly or indirectly. Do not use it for such purposes.



Precautions for Correct Use

Do not use the product in atmospheres or environments that exceed product ratings.

Amplifier Unit

● Designing

Operation after Turning Power ON

The Sensor is ready to detect within 200 ms after the power supply is turned ON. If the Sensor and load are connected to separate power supplies, be sure to turn ON the Sensor first.

● Mounting

Connecting and Disconnecting Connectors

Mounting Connectors

1. Insert the Master or Slave Connector into the Amplifier Unit until it clicks into place.

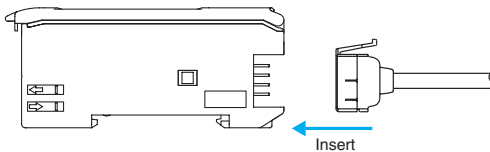

2. Attach the protector seals (provided as accessories) to the sides of master and slave connectors that are not connected.

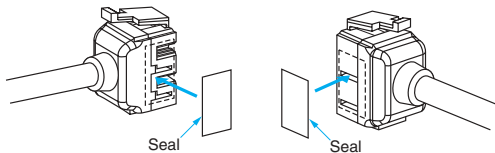

Note: Attach the seals to the sides with grooves.

Removing Connectors

1. Slide the slave Amplifier Unit(s) for which the Connector is to be removed away from the rest of the group.
2. After the Amplifier Unit(s) has been separated, press down on the lever on the Connector and remove it. (Do not attempt to remove Connectors without separating them from other Amplifier Units first.)

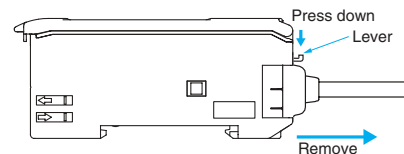

Adding and Removing Amplifier Units

Adding Amplifier Units

1. Mount the Amplifier Units one at a time onto the DIN track.

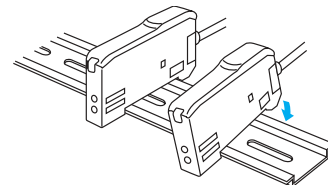

2. Slide the Amplifier Units together, line up the clips, and press the Amplifier Units together until they click into place.

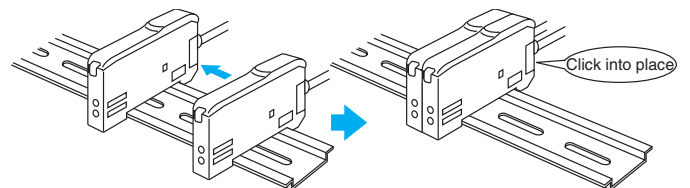

Removing Amplifier Units

Slide Amplifier Units away from each other, and remove from the DIN track one at a time. (Do not attempt to remove Amplifier Units from the DIN track without separating them first.)

- Note: 1. The specifications for ambient temperature will vary according to the number of Amplifier Units used together. For details, refer to *Ratings and Specifications*.
2. Always turn OFF the power supply before joining or separating Amplifier Units.

Mounting the End Plate (PFP-M)

An End Plate should be used if there is a possibility of the Amplifier Unit moving, e.g., due to vibration. If a Mobile Console is going to be mounted, connect the End Plate in the direction shown in the following diagram.

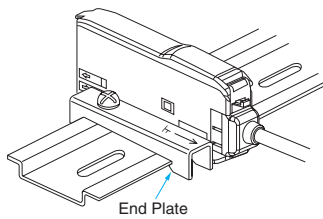

Mounting the Mobile Console Head

Leave a gap of at least 20 mm between the nearest Amplifier Unit and the Mobile Console head.

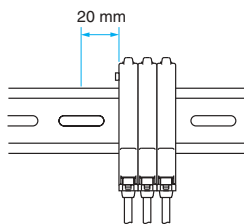

Fiber Connection

The E3X Amplifier Unit has a lock button for easy connection of the Fiber Unit. Connect or disconnect the fibers using the following procedures:

1. Connection

Open the protective cover, insert the fibers according to the fiber insertion marks on the side of the Amplifier Unit, and lower the lock lever.

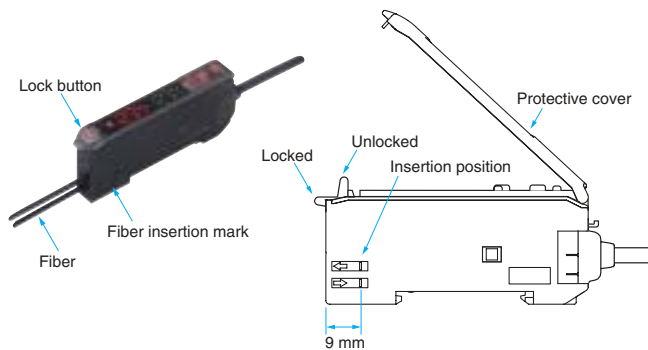

Fibers with E39-F9 Attachment

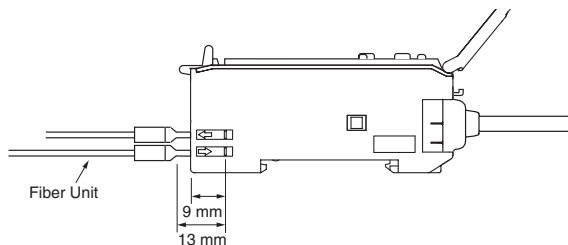

Fibers That Cannot Be Free-Cut (with Sleeves)

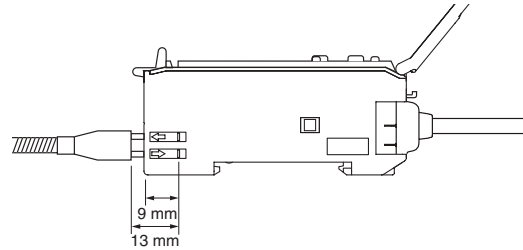

2. Disconnecting Fibers

Remove the protective cover and raise the lock lever to pull out the fibers.

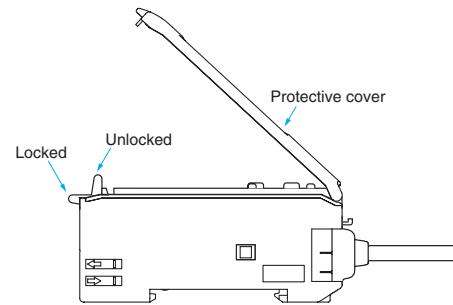

Note: 1. To maintain the fiber properties, confirm that the lock is released before removing the fibers.
2. Be sure to lock or unlock the lock button within an ambient temperature range between -10°C and 40°C .

● Adjusting

Mutual Interference Protection Function

There may be some instability in the digital display values due to light from other sensors. If this occurs, decrease the sensitivity (i.e., decrease the power or increase the threshold) to perform stable detection.

EEPROM Writing Error

If the data is not written to the EEPROM correctly due to a power failure or static-electric noise, initialize the settings with the keys on the Amplifier Unit. ERR/EEP will flash on the display when a writing error has occurred.

Optical Communications

Several Amplifier Units can be slid together and used in groups. Do not, however, slide the Amplifier Units or attempt to remove any of the Amplifier Units during operation.

● Others

Protective Cover

Always keep the protective cover in place when using the Amplifier Unit.

Mobile Console

Use the E3X-MC11-SV2 Mobile Console for the E3X-DA-S-series Amplifier Units.

Dimensions

Amplifier Units

Amplifier Units with Cables

- E3X-DA11-S
- E3X-DA41-S
- E3X-DAG11-S
- E3X-DAG41-S
- E3X-DAB11-S
- E3X-DAB41-S
- E3X-DA11RM-S
- E3X-DA41RM-S
- E3X-DA11TW-S
- E3X-DA41TW-S
- E3X-DA11SE-S
- E3X-DA41SE-S
- E3X-DA11AT-S
- E3X-DA41AT-S
- E3X-DA11AN-S
- E3X-DA41AN-S
- E3X-MDA11
- E3X-MDA41

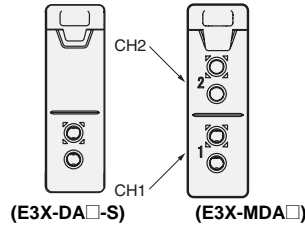
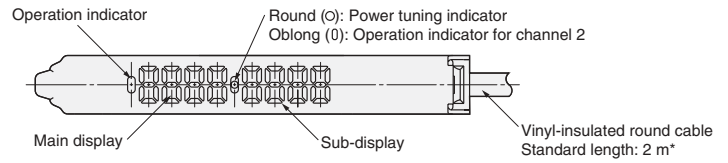

*Cable Specifications

E3X-DA11-S -DA41-S -DAG11-S -DAG41-S -DAB11-S -DAB41-S	4-dia., 3-conductor (Conductor cross section: 0.2 mm ² , insulator diameter: 1.1 mm)
E3X-DA11TW-S -DA41TW-S -DA11RM-S -DA41RM-S	4-dia., 4-conductor (Conductor cross section: 0.2 mm ² , insulator diameter, 1.1 mm)
E3X-MDA11 -MDA41	4-dia., 2-conductor (Conductor cross section: 0.2 mm ² , insulator diameter: 1.1 mm)

With Mounting Bracket Attached

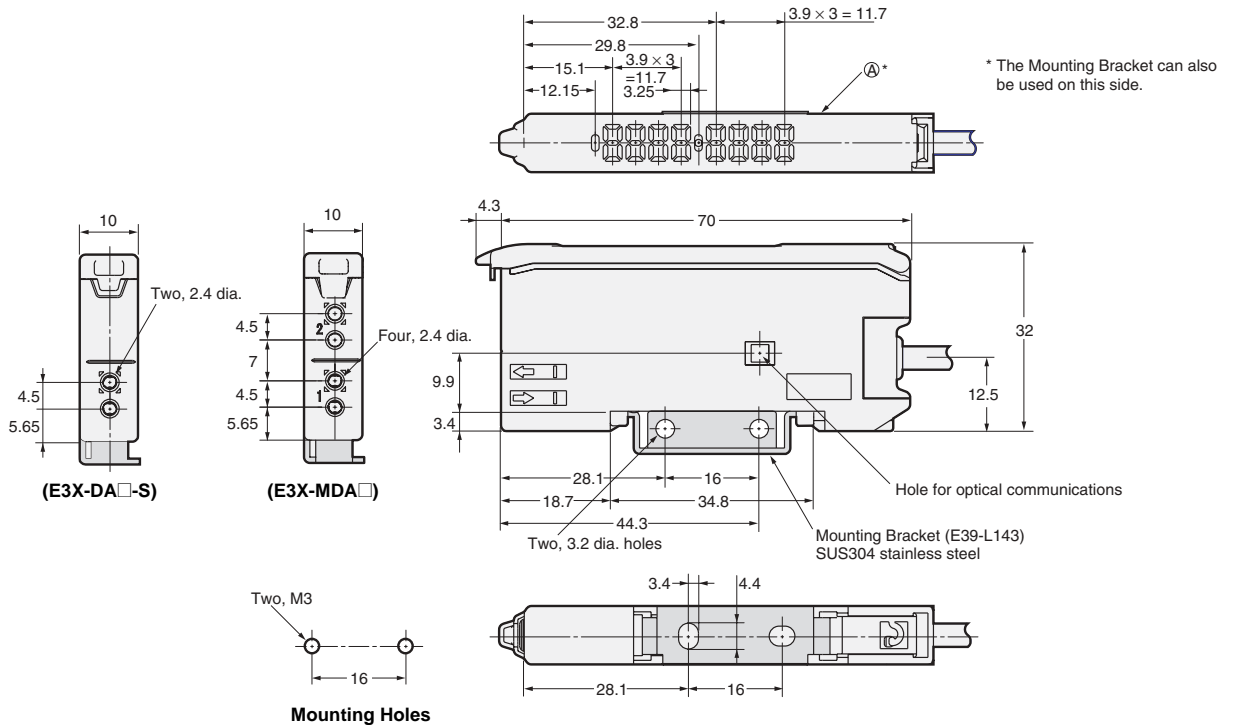

Amplifier Units with Connectors

- E3X-DA6-S
- E3X-DA8-S
- E3X-DAG6-S
- E3X-DAG8-S
- E3X-DAB6-S
- E3X-DAB8-S
- E3X-DA6RM-S
- E3X-DA8RM-S
- E3X-DA6TW-S
- E3X-DA8TW-S
- E3X-DA6SE-S
- E3X-DA8SE-S
- E3X-DA6AT-S
- E3X-DA8AT-S
- E3X-MDA6
- E3X-MDA8

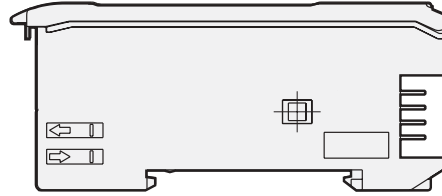
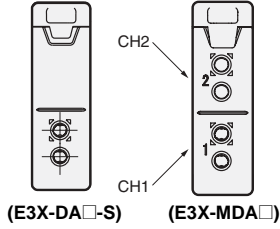
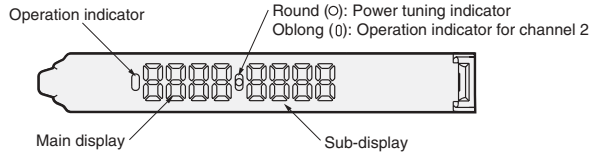

With Mounting Bracket Attached

*1 The Mounting Bracket can also be used on this side.

*2 Cable Diameters

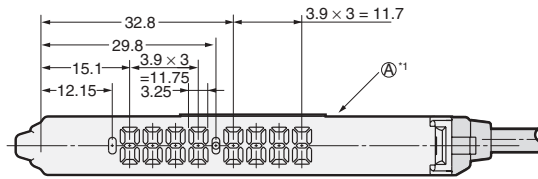

E3X-CN22 (2 conductors)	4.0-mm dia.
E3X-CN21 (4 conductors)	
E3X-CN11 (3 conductors)	
E3X-CN12 (1 conductor)	2.6-mm dia.

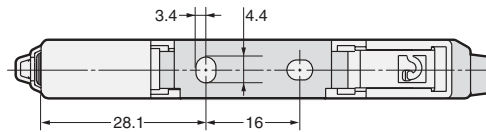
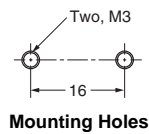
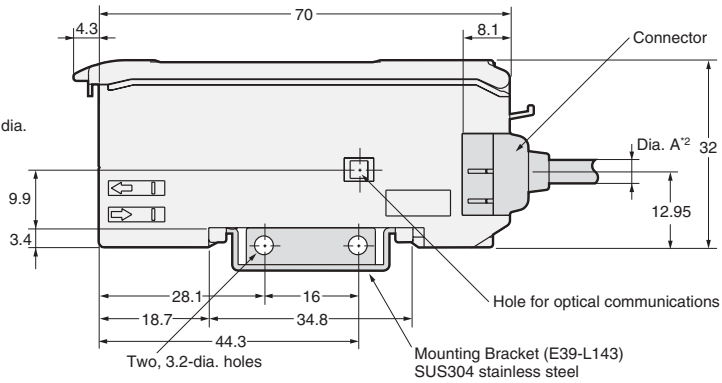
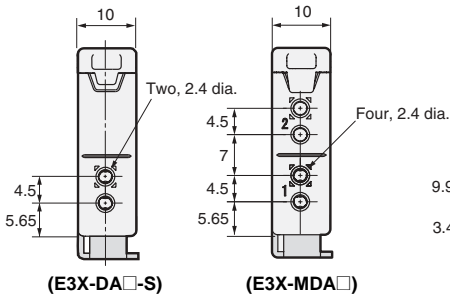

Amplifier Unit Connectors

Master Connectors

E3X-CN11
E3X-CN21

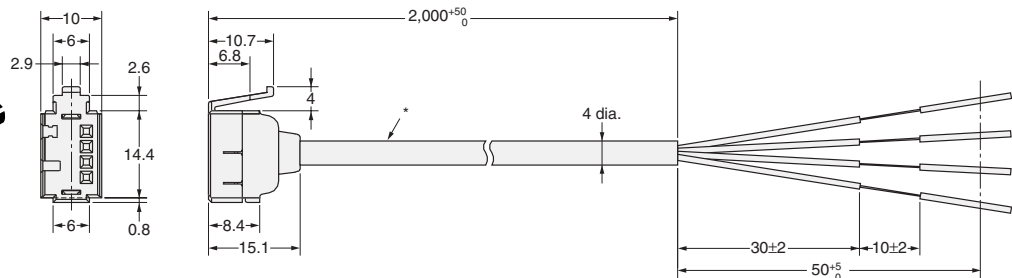
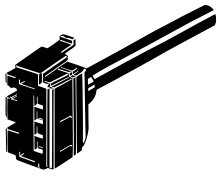

*E3X-CN11: 4-dia. vinyl-insulated round cable with 3 conductors (Conductor cross section: 0.2 mm², Insulator diameter: 1.1 mm)
E3X-CN21: 4-dia. vinyl-insulated round cable with 4 conductors (Conductor cross section: 0.2 mm², Insulator diameter: 1.1 mm)

Slave Connectors

E3X-CN12
E3X-CN22

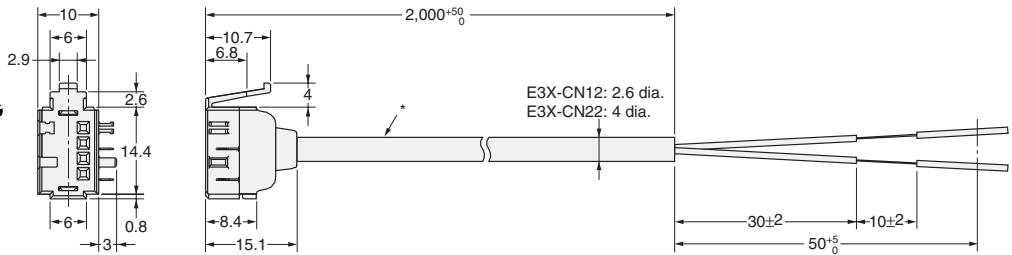
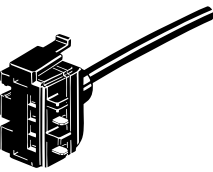

*E3X-CN12: 2.6-dia. vinyl-insulated round cable with 1 conductor (Conductor cross section: 0.2 mm², Insulator diameter: 1.1 mm)
E3X-CN22: 4-dia. vinyl-insulated round cable with 2 conductors (Conductor cross section: 0.2 mm², Insulator diameter: 1.1 mm)

Mobile Console

E3X-MC11-SV2

Mobile Console

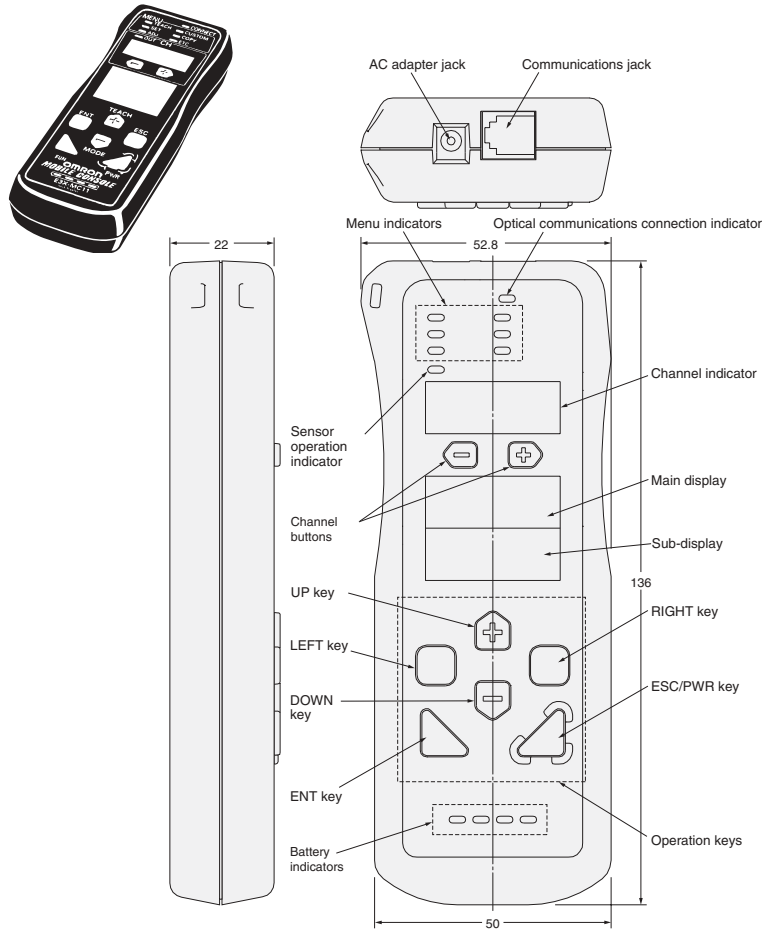

Mobile Console Head

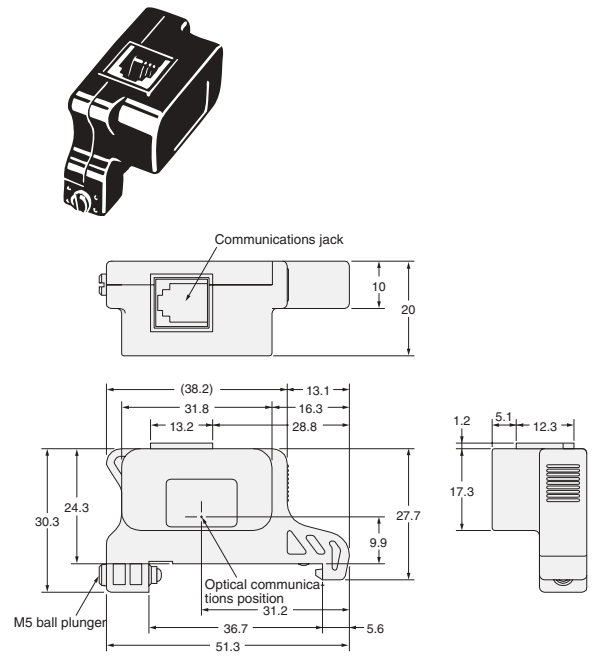

Refer to *E32 Series* for details on Fiber Units.

Read and Understand This Catalog

Please read and understand this catalog before purchasing the products. Please consult your OMRON representative if you have any questions or comments.

Warranty and Limitations of Liability

WARRANTY

OMRON's exclusive warranty is that the products are free from defects in materials and workmanship for a period of one year (or other period if specified) from date of sale by OMRON.

OMRON MAKES NO WARRANTY OR REPRESENTATION, EXPRESS OR IMPLIED, REGARDING NON-INFRINGEMENT, MERCHANTABILITY, OR FITNESS FOR PARTICULAR PURPOSE OF THE PRODUCTS. ANY BUYER OR USER ACKNOWLEDGES THAT THE BUYER OR USER ALONE HAS DETERMINED THAT THE PRODUCTS WILL SUITABLY MEET THE REQUIREMENTS OF THEIR INTENDED USE. OMRON DISCLAIMS ALL OTHER WARRANTIES, EXPRESS OR IMPLIED.

LIMITATIONS OF LIABILITY

OMRON SHALL NOT BE RESPONSIBLE FOR SPECIAL, INDIRECT, OR CONSEQUENTIAL DAMAGES, LOSS OF PROFITS OR COMMERCIAL LOSS IN ANY WAY CONNECTED WITH THE PRODUCTS, WHETHER SUCH CLAIM IS BASED ON CONTRACT, WARRANTY, NEGLIGENCE, OR STRICT LIABILITY.

In no event shall the responsibility of OMRON for any act exceed the individual price of the product on which liability is asserted.

IN NO EVENT SHALL OMRON BE RESPONSIBLE FOR WARRANTY, REPAIR, OR OTHER CLAIMS REGARDING THE PRODUCTS UNLESS OMRON'S ANALYSIS CONFIRMS THAT THE PRODUCTS WERE PROPERLY HANDLED, STORED, INSTALLED, AND MAINTAINED AND NOT SUBJECT TO CONTAMINATION, ABUSE, MISUSE, OR INAPPROPRIATE MODIFICATION OR REPAIR.

Application Considerations

SUITABILITY FOR USE

OMRON shall not be responsible for conformity with any standards, codes, or regulations that apply to the combination of products in the customer's application or use of the products.

At the customer's request, OMRON will provide applicable third party certification documents identifying ratings and limitations of use that apply to the products. This information by itself is not sufficient for a complete determination of the suitability of the products in combination with the end product, machine, system, or other application or use.

The following are some examples of applications for which particular attention must be given. This is not intended to be an exhaustive list of all possible uses of the products, nor is it intended to imply that the uses listed may be suitable for the products:

- Outdoor use, uses involving potential chemical contamination or electrical interference, or conditions or uses not described in this catalog.
- Nuclear energy control systems, combustion systems, railroad systems, aviation systems, medical equipment, amusement machines, vehicles, safety equipment, and installations subject to separate industry or government regulations.
- Systems, machines, and equipment that could present a risk to life or property.

Please know and observe all prohibitions of use applicable to the products.

NEVER USE THE PRODUCTS FOR AN APPLICATION INVOLVING SERIOUS RISK TO LIFE OR PROPERTY WITHOUT ENSURING THAT THE SYSTEM AS A WHOLE HAS BEEN DESIGNED TO ADDRESS THE RISKS, AND THAT THE OMRON PRODUCTS ARE PROPERLY RATED AND INSTALLED FOR THE INTENDED USE WITHIN THE OVERALL EQUIPMENT OR SYSTEM.

PROGRAMMABLE PRODUCTS

OMRON shall not be responsible for the user's programming of a programmable product, or any consequence thereof.

Disclaimers

CHANGE IN SPECIFICATIONS

Product specifications and accessories may be changed at any time based on improvements and other reasons.

It is our practice to change model numbers when published ratings or features are changed, or when significant construction changes are made. However, some specifications of the products may be changed without any notice. When in doubt, special model numbers may be assigned to fix or establish key specifications for your application on your request. Please consult with your OMRON representative at any time to confirm actual specifications of purchased products.

DIMENSIONS AND WEIGHTS

Dimensions and weights are nominal and are not to be used for manufacturing purposes, even when tolerances are shown.

PERFORMANCE DATA

Performance data given in this catalog is provided as a guide for the user in determining suitability and does not constitute a warranty. It may represent the result of OMRON's test conditions, and the users must correlate it to actual application requirements. Actual performance is subject to the OMRON Warranty and Limitations of Liability.

ERRORS AND OMISSIONS

The information in this document has been carefully checked and is believed to be accurate; however, no responsibility is assumed for clerical, typographical, or proofreading errors, or omissions.

2008.11

In the interest of product improvement, specifications are subject to change without notice.

OMRON Corporation
Industrial Automation Company

<http://www.ia.omron.com/>

(c)Copyright OMRON Corporation 2008 All Right Reserved.