

LED NUMERIC DISPLAY, 1 DIGIT, SMD DISPLAY

BL-SS56X-11

Features:

- 14.20mm (0.56") Single digit numeric display series. SMD TYPE
- Low current operation.
- Excellent character appearance.
- Easy mounting on P.C. Boards or sockets.
- I.C. Compatible.
- ROHS Compliance.



Super Bright

Electrical-optical characteristics: (Ta=25°C) (Test Condition: IF=20mA)

Part No		Chip			VF Unit:V		Iv TYP.(mcd)
Common Cathode	Common Anode	Emitted Color	Material	λ_p (nm)	Typ	Max	
BL-SS56A-11S-XX	BL-SS56B-11S-XX	Hi Red	GaAlAs/GaAs,SH	660	1.85	2.20	30
BL-SS56A-11D-XX	BL-SS56B-11D-XX	Super Red	GaAlAs/GaAs,DH	660	1.85	2.20	45
BL-SS56A-11UR-XX	BL-SS56B-11UR-XX	Ultra Red	GaAlAs/GaAs,DDH	660	1.85	2.20	50
BL-SS56A-11E-XX	BL-SS56B-11E-XX	Red	GaAsP/GaP	635	2.10	2.50	35
BL-SS56A-11Y-XX	BL-SS56B-11Y-XX	Yellow	GaAsP/GaP	585	2.10	2.50	35
BL-SS56A-11G-XX	BL-SS56B-11G-XX	Green	GaP/GaP	570	2.20	2.50	35

Ultra Bright

Electrical-optical characteristics: (Ta=25°C) (Test Condition: IF=20mA)

Part No		Chip			VF Unit:V		Iv TYP.(mcd)
Common Cathode	Common Anode	Emitted Color	Material	λ_p (nm)	Typ	Max	
BL-SS56A-11UHR-XX	BL-SS56B-11UHR-XX	Ultra Red	AlGaInP	645	2.10	2.50	50
BL-SS56A-11UE-XX	BL-SS56B-11UE-XX	Ultra Red	AlGaInP	630	2.10	2.50	38
BL-SS56A-11YO-XX	BL-SS56B-11YO-XX	Ultra Amber	AlGaInP	619	2.10	2.50	38
BL-SS56A-11UY-XX	BL-SS56B-11UY-XX	Ultra Yellow	AlGaInP	590	2.10	2.50	38
BL-SS56A-11UG-XX	BL-SS56B-11UG-XX	Ultra Green	AlGaInP	574	2.20	2.50	45
BL-SS56A-11PG-XX	BL-SS56B-11PG-XX	Ultra Pure Green	InGaN	525	3.80	4.50	60
BL-SS56A-11B-XX	BL-SS56B-11B-XX	Ultra Blue	InGaN	470	2.70	4.20	58
BL-SS56A-11W-XX	BL-SS56B-11W-XX	Ultra White	InGaN	/	2.70	4.20	65

■ -XX: Surface / Lens color:

Number	0	1	2	3	4	5
Ref Surface Color	White	Black	Gray	Red	Green	
Epoxy Color	Water clear	White diffused	Red Diffused	Green Diffused	Yellow Diffused	

LED NUMERIC DISPLAY, 1 DIGIT, SMD DISPLAY
BL-SS56X-11
Absolute maximum ratings (Ta=25°C)

Parameter	S	D	UR	E	Y	G	Unit
Forward Current I_F	25	25	25	25	25	30	mA
Power Dissipation P_d	60	60	60	60	60	65	mW
Reverse Voltage V_R	5	5	5	5	5	5	V
Peak Forward Current I_{PF} (Duty 1/10 @1KHZ)	150	150	150	150	150	150	mA
Operation Temperature T_{OPR}	-40 to +80						°C
Storage Temperature T_{STG}	-40 to +85						°C
Lead Soldering Temperature T_{SOL}	Max.260±5°C for 3 sec Max. (1.6mm from the base of the epoxy bulb)						°C

■ Absolute maximum ratings (Ta=25°C)

Parameter	UHR	UE	YO	UY	UG	PG	UB	UW	Unit
Forward Current I_F	30	30	30	30	30	30	30	30	mA
Power Dissipation P_d	75	65	65	65	75	110	120	120	mW
Reverse Voltage V_R	5	5	5	5	5	5	5	5	V
Peak Forward Current I_{PF} (Duty 1/10 @1KHZ)	150	150	150	150	150	150	100	100	mA
Operation Temperature T_{OPR}	-40 to +80								°C
Storage Temperature T_{STG}	-40 to +85								°C
Lead Soldering Temperature T_{SOL}	Max.260±5°C for 3 sec Max. (1.6mm from the base of the epoxy bulb)								°C

LED NUMERIC DISPLAY, 1 DIGIT, SMD DISPLAY

BL-SS56X-11

■ **Package configuration & Internal circuit diagram**

BL-SS56X-11 Series

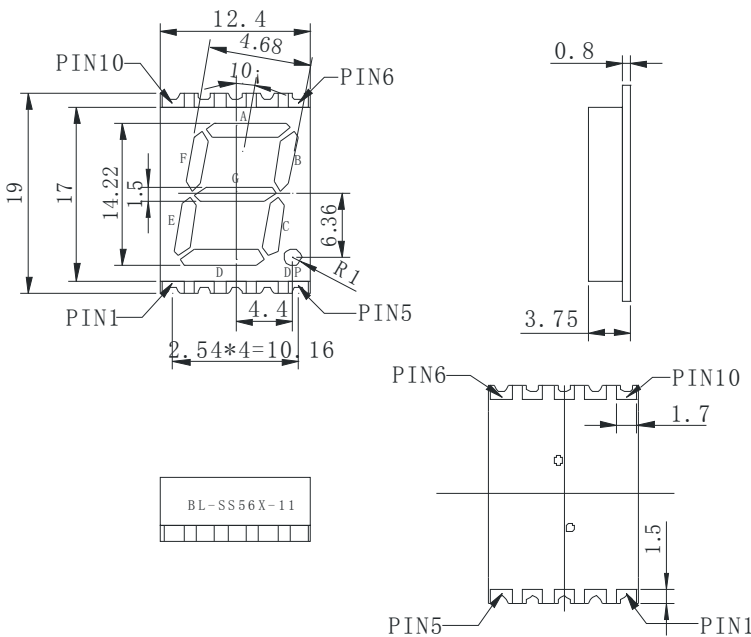

BL-SS56A-11

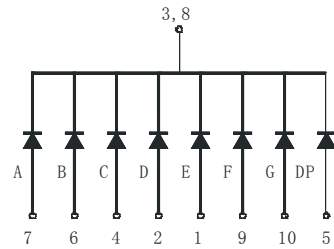

BL-SS56B-11

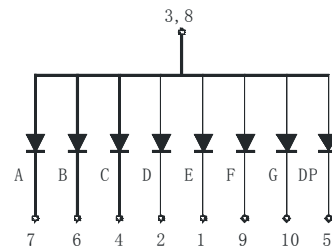

Notes:

1. All dimensions are in millimeters (inches)
2. Tolerance is $\pm 0.25(0.01)$ unless otherwise noted.
3. Specifications are subject to change without notice.

LED NUMERIC DISPLAY, 1 DIGIT, SMD DISPLAY

BL-SS56X-11

Typical electrical-optical characteristics curves:

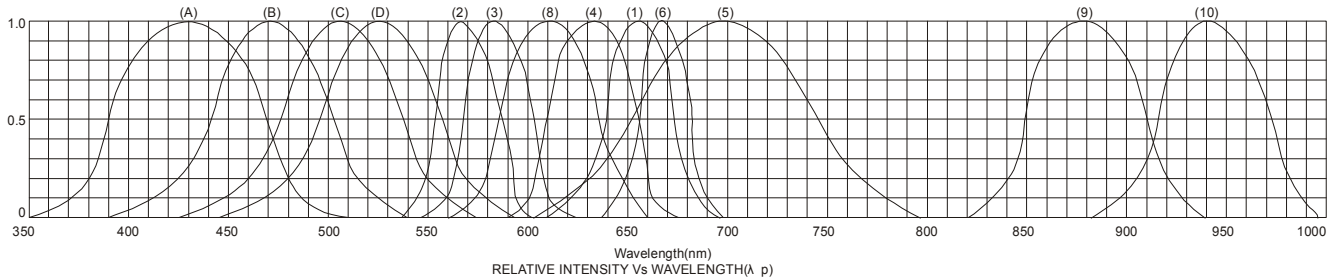

- (1) - GaAsP/GaAs 655nm/Red
- (2) - GaP 570nm/Yellow Green
- (3) - GaAsP/GaP 585nm/Yellow
- (4) - GaAsP/GaP 635nm/Orange & Hi-Eff Red
- (5) - GaP 700nm/Bright Red
- (6) - GaAlAs/GaAs 660nm/Super Red
- (8) - GaAsP/GaP 610nm/Super Red
- (9) - GaAlAs 880nm
- (10) - GaAs/GaAs & GaAlAs/GaAs 940nm
- (A) - GaN/SiC 430nm/Blue
- (B) - InGaN/SiC 470nm/Blue
- (C) - InGaN/SiC 505nm/Ultra Green
- (D) - InGaAl/SiC 525nm/Ultra Green

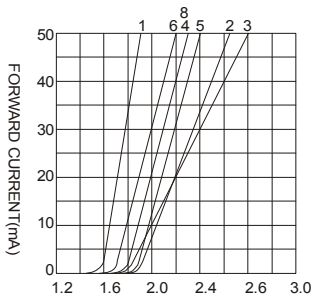

FORWARD VOLTAGE (Vf)
FORWARD CURRENT VS.
FORWARD VOLTAGE

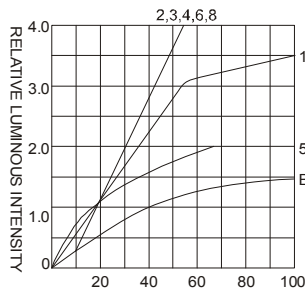

FORWARD CURRENT (mA)
RELATIVE LUMINOUS
INTENSITY VS. FORWARD
CURRENT

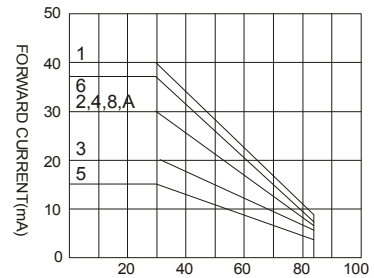

AMBIENT TEMPERATURE Ta(°C)
FORWARD CURRENT VS. AMBIENT
TEMPERATURE

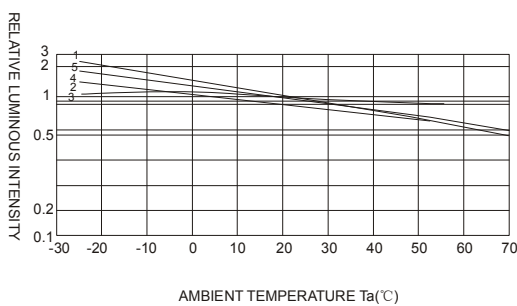

AMBIENT TEMPERATURE Ta(°C)

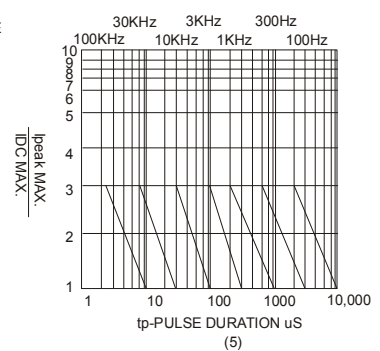
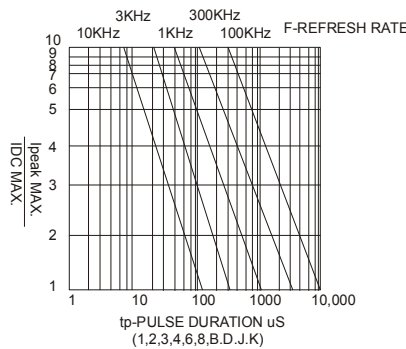

NOTE:25°C free air temperature unless otherwise specified