

max. 20 m³/h

DC axial fans

Series 500 F 50 x 50 x 15 mm



Highlights:

- Compact fan with low power consumption.
- Some models suitable for use at high ambient temperatures.

General characteristics:

- Material: fibreglass-reinforced plastic. Impeller PA, housing PBT.
- Fully integrated electronic commutation.
- Protected against reverse polarity and locking.
- Connection via single strands AWG 28, TR 64. Bared and tin-plated.
- Air exhaust over struts. Direction of rotation counter-clockwise, seen on rotor.
- Mass: 25 g.

Nominal data		Air flow	Air flow	Nominal voltage	Voltage range	Sound pressure level	Sound power level	Sinter sleeve bearings Ball bearings	Power input	Nominal speed	Temperature range	Service life L ₁₀ (20 °C) ebm-papst Standard	Service life L ₁₀ (60 °C) ebm-papst Standard	Life expectancy L ₁₀ Δ (40 °C) see P. 15	Curve	Specials
Type		m ³ /h	CFM	VDC	VDC	dB(A)	Bel(A)	□ / ■	Watts	RPM	°C	Hours	Hours	Hours	P. 110	
512 F		20	11,8	12	10,8...13,2	30	4,5	□	1,0	5 000	-20...+70	50 000 / 20 000	62 500	2	/2	
514 F		20	11,8	24	21,6...26,4	30	4,5	□	1,0	5 000	-20...+70	50 000 / 20 000	62 500	2	/2	
Model with temperature range up to +85 °C.																
512 FL-547		11	6,5	12	11,5...13,2	12	3,7	□	0,4	3 000	-20...+85	50 000 / 20 000	65 500	1		
512 F-532		20	11,8	12	10,8...13,2	30	4,5	□	0,9	5 000	-20...+85	50 000 / 20 000	65 500	2		

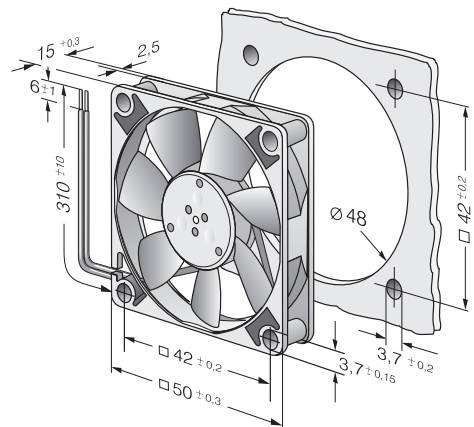
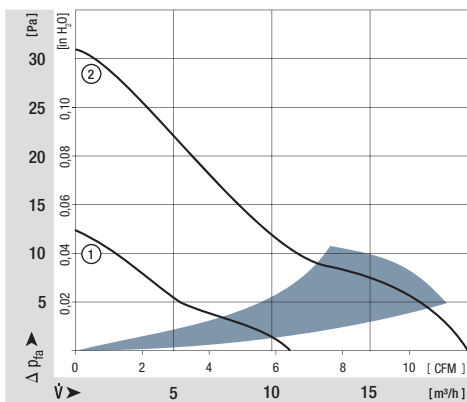

Speed signal /2

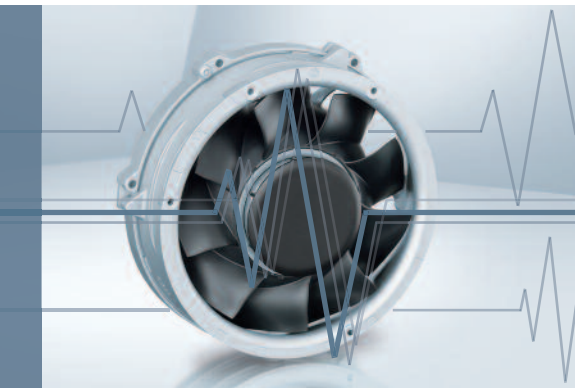

- Speed-proportional, square-wave signal for external monitoring of the fan motor speed
- 2, 3, or 6 pulses per revolution
- Open-collector signal output
- Extremely wide operating voltage range
- Easy adaptation to user interface
- Connection via separate cable
- The sensor signal also serves as a major comparison variable for setting and maintaining the setpoint speed for interactive or controlled cooling with one or more interconnected fans.

Electrical hookup

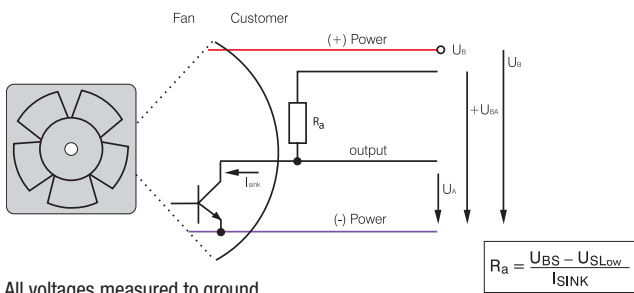

All voltages measured to ground.
External load resistor R_a / U_S / U_{BS} required.

Signal output voltage

Standard signal for all models (exceptions see below)

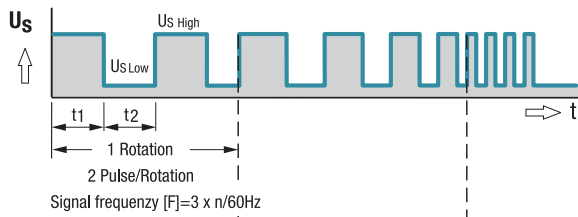

For multi options control input and 4100 NH7 and NH8

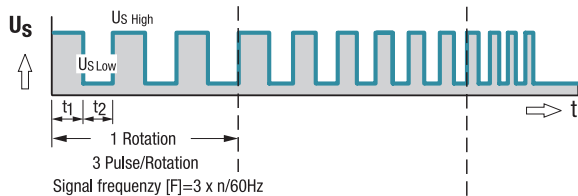

All TD Fans e.g. 6300 TD

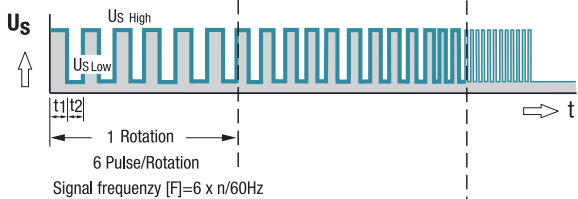

Fan speed

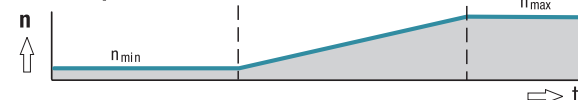

Signal data	Speed signal	Condition:	Speed signal	Condition:	Tach operating	Admissible sink current	Pulses per revolution	Fan description
	$U_{S\text{ Low}}$	I_{sink}	$U_{S\text{ High}}$	I_{source}	voltage $U_{BS\text{ max}}$	$I_{\text{sink max}}$		Basic type
Type	VDC	mA	VDC	mA	VDC	mA	Page	
250	≤ 0.4	2	≤ 30	0	30	2	2	31
400 F	≤ 0.4	1	≤ 30	0	30	2	2	32
400	≤ 0.4	1	≤ 30	0	30	2	2	33
420 J	≤ 0.4	2	≤ 15	0	15	4	2	34
500 F	≤ 0.4	1	≤ 30	0	30	2	2	35
600 F	≤ 0.4	1	≤ 30	0	30	2	2	36
620	≤ 0.4	2	≤ 30	0	30	4	2	37
630 U	≤ 0.4	2	≤ 30	0	30	4	2	38
600 N	≤ 0.4	2	≤ 28	0	28	4	2	39
600 J	≤ 0.4	2	≤ 30	0	30	4	2	41
700 F	≤ 0.4	2	≤ 30	0	30	4	2	42
8450	≤ 0.4	2	≤ 28	0	28	4	2	43
8400 N	≤ 0.4	2	≤ 28	0	28	4	2	44
8400 N VARIOFAN	≤ 0.4	2	≤ 30	0	30	4	2	45
8300	≤ 0.4	2	≤ 30	0	30	4	2	46
8200 J	≤ 0.4	2	≤ 30	0	30	4	2	47
3400 N	≤ 0.4	2	≤ 28	0	28	4	2	48
3400 N VARIOFAN	≤ 0.4	2	≤ 30	0	30	4	2	49
3300 N	≤ 0.4	2	≤ 30	0	30	4	2	50
3212 J / 3214 J	≤ 0.4	2	≤ 30	0	30	4	2	51
3218 J	≤ 0.4	2	≤ 60	0	60	4	2	51
3250 J	≤ 0.4	2	≤ 60	0	60	4	3	52
4412 F / 4414 F	≤ 0.4	2	≤ 30	0	30	4	2	53
4418 F	≤ 0.4	2	≤ 60	0	60	4	2	53
4400 FN	≤ 0.4	2	≤ 30	0	30	4	2	55
4312 / 4314	≤ 0.4	2	≤ 30	0	30	4	2	56
4318	≤ 0.4	2	≤ 60	0	60	4	2	56
4312 / 4314 VARIOFAN	≤ 0.4	2	≤ 30	0	30	4	2	57
4318 VARIOFAN	≤ 0.4	2	≤ 60	0	60	4	2	57
4400	≤ 0.4	2	≤ 30	0	30	4	2	58/59
4100 N	≤ 0.4	2	≤ 30	0	30	4	2	60
4100 NHH...NH6	≤ 0.4	2	≤ 60	0	60	10	2	61
4100 NH7...NH8	≤ 0.4	2	≤ 60	0	60	20	3	62
DV 4100	≤ 0.4	2	≤ 30	0	30	4	2	63
5200 N	≤ 0.4	2	≤ 30	0	30	4	2	64
DV 5200	≤ 0.4	2	≤ 30	0	30	4	2	65

Subject to change

Available on request:

- Electrically isolated speed signal circuit
- Varying voltage potentials for power and logic circuit

Signal data	Speed signal $U_{S\text{ Low}}$	Condition: I_{sink}	Speed signal $U_{S\text{ High}}$	Condition: I_{source}	Tach operating voltage $U_{BS\text{ max}}$	Admissible sink current $I_{\text{sink max}}$	Pulses per revolution	Fan description Basic type
Type	VDC	mA	VDC	mA	VDC	mA		Page
5112 N	≤ 0.4	2	≤ 15	0	5	20	2	66
5114 N / 5118 N	≤ 0.4	2	≤ 60	0	60	20	2	66
5300	≤ 0.4	2	≤ 60	0	60	4	2	67
5300 TD	≤ 0.4	2	≤ 60	0	60	20	6	68
7112 N / 7118 N	≤ 0.4	2	≤ 60	0	60	20	2	69
7114 N	≤ 0.4	2	≤ 30	0	30	20	2	69
7200 N	≤ 0.4	2	≤ 15	0	15	20	2	70
6400	≤ 0.4	2	≤ 60	0	60	20	2	71
6300 TD	≤ 0.4	2	≤ 60	0	60	20	6	75
6300 N	≤ 0.4	2	≤ 60	0	60	20	6	76
6300 NTD	≤ 0.4	2	≤ 60	0	60	20	6	77
6300	≤ 0.4	2	≤ 60	0	60	20	2	78
DV 6300 TD	≤ 0.4	2	≤ 60	0	60	20	6	80
2200 FTD	≤ 0.4	2	≤ 60	0	60	20	6	81
RL 48	≤ 0.4	2	≤ 30	0	30	4	2	97
RL 65	≤ 0.4	2	≤ 30	0	30	4	2	98
RL 90 N	≤ 0.4	2	≤ 30	0	30	4	2	99
RLF 100	≤ 0.4	2	≤ 30	0	30	4	2	100
RG 90 N	≤ 0.4	2	≤ 30	0	30	4	2	101
RG 125 N	≤ 0.4	2	≤ 30	0	30	4	2	102
RG 140 N	≤ 0.4	3	≤ 60	0	60	4	2	103
RG 160 N	≤ 0.4	2	≤ 30	0	30	20	2	104
RG 160 NTD	≤ 0.4	2	≤ 60	0	60	20	6	105
RG 190 TD	≤ 0.4	2	≤ 60	0	60	20	6	106
RG 220 TD	≤ 0.4	2	≤ 60	0	60	20	6	107
RG 225 TD	≤ 0.4	2	≤ 60	0	60	20	6	108
RET 97 TD	≤ 0.4	2	≤ 60	0	60	20	6	109
REF 100	≤ 0.4	2	≤ 30	0	30	4	2	110
RER 120 TD	≤ 0.4	2	≤ 60	0	60	20	6	112
RER 133 TD	≤ 0.4	2	≤ 60	0	60	20	6	117
RER 160 NTD	≤ 0.4	2	≤ 60	0	60	20	6	119
REF 175 TD	≤ 0.4	2	≤ 60	0	60	20	6	120
RER 175 TD	≤ 0.4	2	≤ 60	0	60	20	6	121
RER 190 TD	≤ 0.4	2	≤ 60	0	60	20	6	122
RER 220 TD	≤ 0.4	2	≤ 60	0	60	20	6	128
RER 225 TD	≤ 0.4	2	≤ 60	0	60	20	6	129

Subject to change

Note:

Fans that come with these fan specials could have variations with respect to the temperature range, voltage range, and power consumption compared to standard fans without specials.