

DRAWING NOSHEET MODEL NAME ISSUE
SPL8801 1 OF 6 ASS8800 6

LOW PROFILE LED FLOODLIGHT



Marl International Limited
 Marl Business Park
 Ulverston
 Cumbria
 LA12 9BN
 t: +44 (0) 1229 582430
 f: +44 (0) 1229 585155
 e: sales@marl.co.uk
 w: www.marl.co.uk

ISSUE	MODIFICATION	DRN	DATE
1	ORIGINAL ISSUE	RE	05/01/11
2	035/11	RW	20/05/11
3	074/11	GR	14/09/11
4	102/11	RW	17/11/11
5	107/11	DT	22/12/11
6	025/12	DT	19/03/12

**11/04/12
 NON-MAINTAINED
 COPY**



OVERVIEW

THE MARL LOW PROFILE FLOOD LIGHT COMBINES THE LATEST OSRAM GOLDEN DRAGON LEDS WITH HIGH-EFFICIENCY OPTICS, PSU AND OPTIMISED THERMAL DESIGN TO ACHIEVE A TOTAL LUMEN OUTPUT OF UP TO 3000 LUMENS MAKING IT THE IDEAL ANSWER TO LOW ENERGY FLOOD LIGHTING SOLUTIONS. SPECIAL CARE HAS BEEN TAKEN TO PROVIDE A UNIFORM ILLUMINATION USING OPTICAL GRADE PMMA LENSES. THE ROBUST HOUSING IS POWDER COATED TO PROVIDE LONG TERM ENVIRONMENTAL PROTECTION AND IS IP RATED TO IP66. THE FLOODLIGHT HAS BEEN DESIGNED FOR SIMPLE INSTALLATION WITH ADJUSTABLE MOUNTING BRACKET AND PRE-TERMINATED WITH UV STABILISED POWER CABLE.

ELECTRICAL

INPUT POWER: 60W
 INPUT VOLTAGE: 110-240VAC (240VAC WITH PHOTOCELL)
 FREQUENCY: 47-63Hz
 POWER FACTOR: >0.97/115VAC 0.95/230VAC
 INRUSH CURRENT: COLD START 75A/230VAC
 AC CURRENT: (0.8A/115VAC 0.4A/230VAC)
 PROTECTION: OVER VOLTAGE / CURRENT / TEMPERATURE & S/C
 AMBIENT OPERATING TEMPERATURE: -30°C TO +45°C
 STORAGE TEMPERATURE: -40°C TO +80°C
 LED: OSRAM GOLDEN DRAGON PLUS
 COMPLIANCE TO WORLDWIDE SAFETY REGULATIONS FOR LIGHTING

OPTICAL

MEDIUM VIEWING ANGLE (FWHM): 26°
 WIDE VIEWING ANGLE (FWHM): 44°
 EXTRA WIDE VIEWING ANGLE (FWHM): 106°±54°
 OVAL VIEWING ANGLE (FWHM): 12°±48°
 COLOUR TEMP: >5000K
 CRI (TYP): 70

MECHANICAL

IP RATING: IP66
 GLASS: TEMPERED
 HOUSING: DIE-CAST ALUMINIUM POWDER COATED
 WEIGHT: 8.1 KG
 CABLE SPEC: PVC INSULATED PUR SHEATHED
 3-CORE 16/0.2MM, 7.1MM OD
 CABLE LENGTH: 2M

FEATURES

- HIGH EFFICIENCY COMPONENTS USED FOR MAXIMUM ENERGY SAVING.
- LONG LIFE AND RELIABILITY ELIMINATE MAINTENANCE PERIOD FOR 60,000HRS (13 YRS @12 HRS PER DAY).
- DURABLE POWDER COATED IP66 HOUSING WITH TEMPERED GLASS.
- EQUIVALENT TO 250W HALOGEN FLOOD LIGHT WITH UP TO 30 x LONGER LIFE EXPECTANCY.

PART NUMBERS

ORDER CODE	HOUSING COLOR	BEAM ANGLE
748-980-76-50	BLACK	WIDE
748-980-76-51	BLACK	MEDIUM
748-980-76-52	WHITE	WIDE
748-980-76-53	WHITE	MEDIUM
748-980-76-54*	BLACK	MEDIUM
748-980-76-55*	BLACK	WIDE
748-980-76-56	BLACK	EXTRA WIDE
748-980-76-57	BLACK	OVAL

* - WITH PHOTOCELL FOR DUSK TO DAWN OPERATION (SEE SHEET 2).



TOLERANCE/ SCALE UOS		DRN: RE
LINEAR N/A		DATE: 05/01/11
ANGULAR N/A		CHK1: RW
ORIGINAL SCALE N/A	ALL DIMENSIONS IN MM	CHK2: NJO

DRAWING NOSHEET MODEL NAME ISSUE
SPL8801 2 OF 6 ASS8800 6

LOW PROFILE LED FLOODLIGHT



Marl International Limited
Marl Business Park
Ulverston
Cumbria
LA12 9BN
t: +44 (0) 1229 582430
f: +44 (0) 1229 585155
e: sales@marl.co.uk
w: www.marl.co.uk

ISSUE	MODIFICATION	DRN	DATE
1	ORIGINAL ISSUE	RE	05/01/11
2	035/11	RW	20/05/11
3	074/11	GR	14/09/11
4	102/11	RW	17/11/11
5	107/11	DT	22/12/11
6	025/12	DT	19/03/12

PRODUCT DIMENSIONS

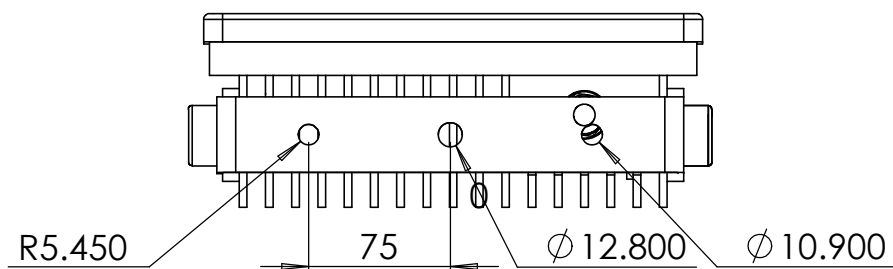

*DUSK TO DAWN SENSOR SPECIFICATION

SUPPLY VOLTAGE: 240VAC.
 SWITCHING LEVEL: 70 LUX (APPROX).
 CLEAN WITH SOFT DRY CLOTH.
 DO NOT USE ANY CHEMICAL OR ABRASIVE CLEANERS.
 SENSOR HOUSING MATERIAL: THERMOPLASTIC MOULDING.
 NB.TOUGHENED GLASS IS REPLACED WITH LEXAN F2000 POLYCARB

FEATURES

- HIGH EFFICIENCY COMPONENTS USED FOR MAXIMUM ENERGY SAVING.
- LONG LIFE AND RELIABILITY ELIMINATE MAINTENANCE PERIOD FOR 60,000HRS (13 YRS @12 HRS PER DAY).
- DURABLE POWDER COATED IP66 HOUSING WITH TEMPERED GLASS.
- EQUIVALENT TO 250W HALOGEN FLOOD LIGHT WITH UP TO 30 x LONGER LIFE EXPECTANCY.

11/04/12
NON-MAINTAINED
COPY

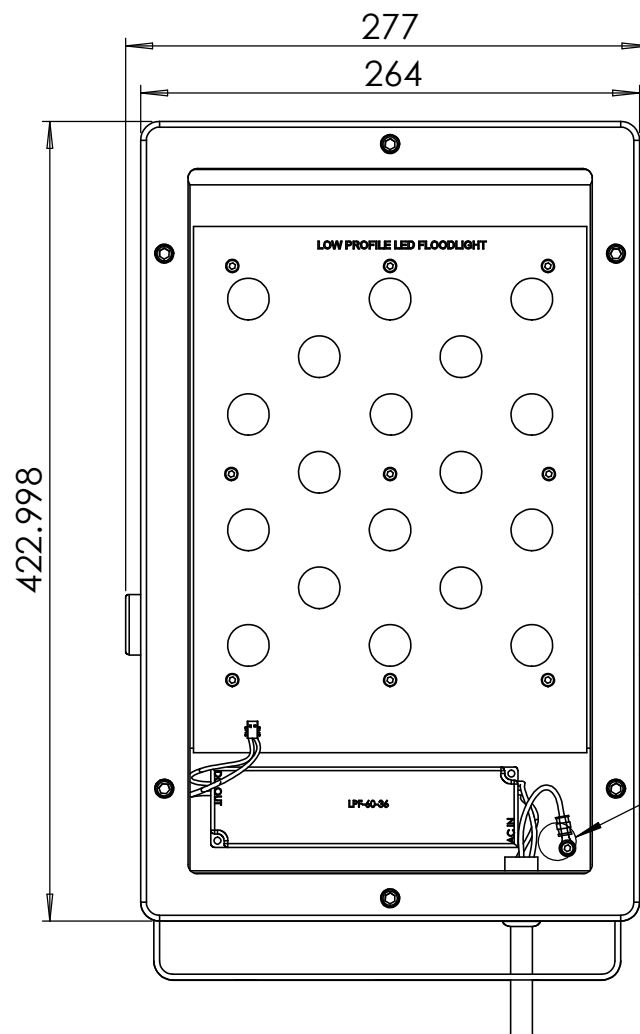
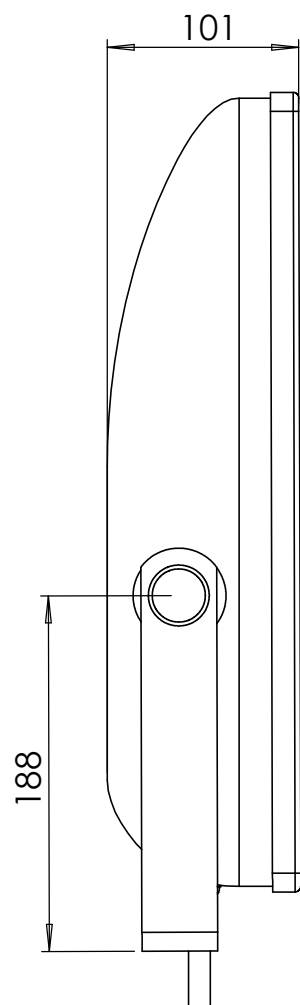

* OPTIONAL DUSK TO DAWN SENSOR.



TOLERANCE/ SCALE UOS
 LINEAR ±0.1
 ANGULAR N/A
 ORIGINAL SCALE 1:4

ALL DIMENSIONS IN MM

DRN: RE
 DATE: 05/01/11
 CHK1: RW
 CHK2: NJO

DRAWING NOSHEET MODEL NAME ISSUE
SPL8801 3 OF 6 ASS8800 6

LOW PROFILE LED FLOODLIGHT



Marl International Limited
 Marl Business Park
 Ulverston
 Cumbria
 LA12 9BN
 t: +44 (0) 1229 582430
 f: +44 (0) 1229 585155
 e: sales@marl.co.uk
 w: www.marl.co.uk

ISSUE	MODIFICATION	DRN	DATE
1	ORIGINAL ISSUE	RE	05/01/11
2	035/11	RW	20/05/11
3	074/11	GR	14/09/11
4	102/11	RW	17/11/11
5	107/11	DT	22/12/11
6	025/12	DT	19/03/12

ILLUMINANCE LEVELS OF MEDIUM AND WIDE FLOODLIGHT

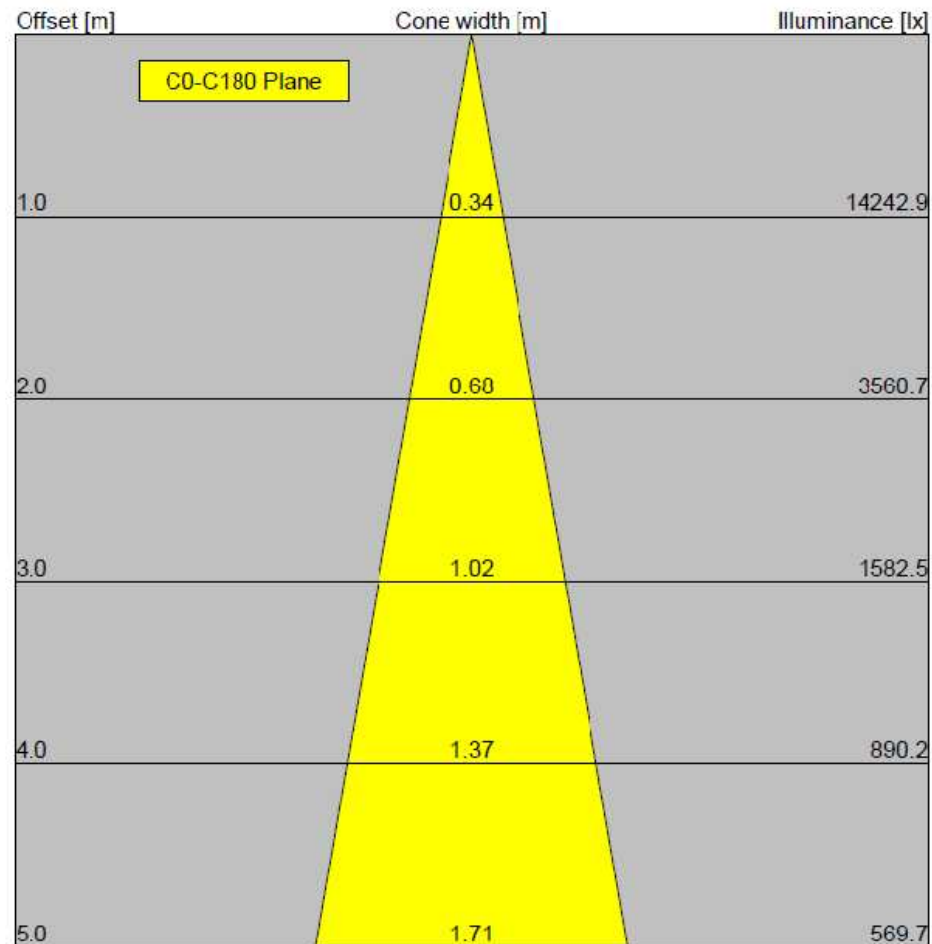

Note: The illuminance is calculated with $I(\gamma=0)!$
 ILLUMINANCE READINGS FOR MEDIUM OPTIC FLOOD LIGHT

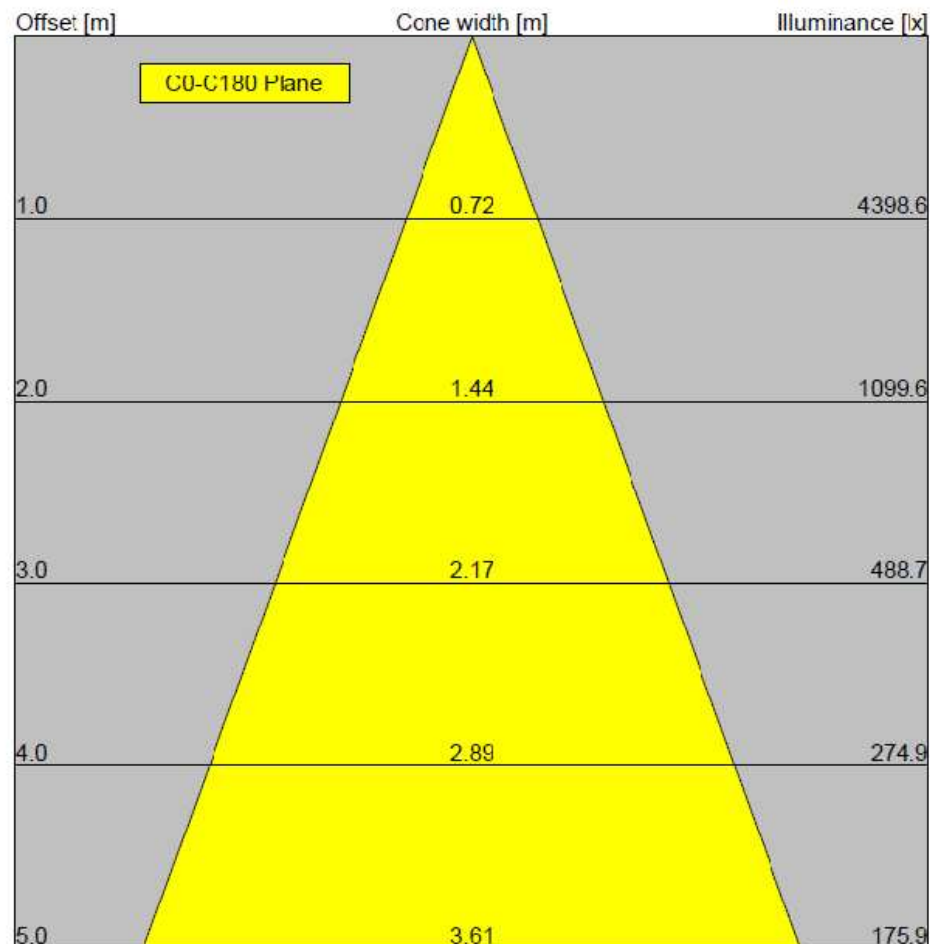

Note: The illuminance is calculated with $I(\gamma=0)!$
 ILLUMINANCE READINGS FOR WIDE OPTIC FLOOD LIGHT

FEATURES

- HIGH EFFICIENCY COMPONENTS USED FOR MAXIMUM ENERGY SAVING.
- LONG LIFE AND RELIABILITY ELIMINATE MAINTENANCE PERIOD FOR 60,000HRS (13 YRS @ 12 HRS PER DAY).
- DURABLE POWDER COATED IP66 HOUSING WITH TEMPERED GLASS.
- EQUIVALENT TO 250W HALOGEN FLOOD LIGHT WITH UP TO 30 x LONGER LIFE EXPECTANCY.



**11/04/12
 NON-MAINTAINED
 COPY**

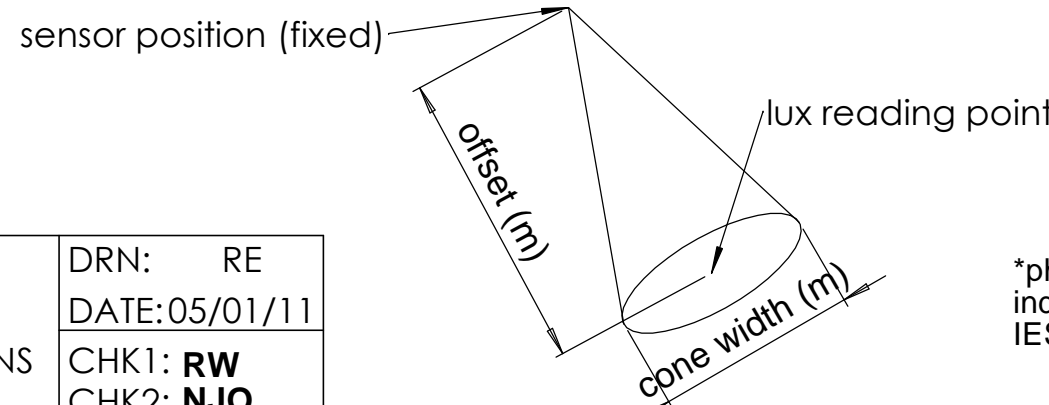

*photometric testing completed by independent test house (42 partners ltd)
 IES files are available on request

TOLERANCE/ SCALE UOS		DRN: RE
LINEAR ±0.1		DATE:05/01/11
ANGULAR ±1°		CHK1: RW
ORIGINAL SCALE NA	ALL DIMENSIONS IN MM	CHK2: NJO

DRAWING NOSHEET MODEL NAME ISSUE
SPL8801 4 OF 6 ASS8800 6

LOW PROFILE LED FLOODLIGHT



Marl International Limited
 Marl Business Park
 Ulverston
 Cumbria
 LA12 9BN
 t: +44 (0) 1229 582430
 f: +44 (0) 1229 585155
 e: sales@marl.co.uk
 w: www.marl.co.uk

ISSUE	MODIFICATION	DRN	DATE
1	ORIGINAL ISSUE	RE	05/01/11
2	035/11	RW	20/05/11
3	074/11	GR	14/09/11
4	102/11	RW	17/11/11
5	107/11	DT	22/12/11
6	025/12	DT	19/03/12

EXTRA WIDE AND OVAL FLOODLIGHT BEAM ANGLE DETAILS

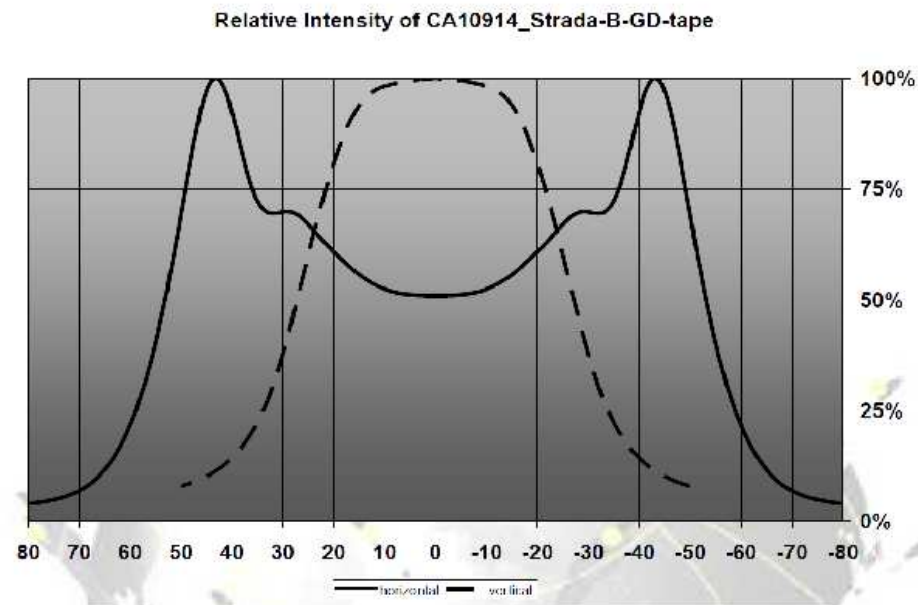

BEAM DISTRIBUTION PLOT OF EXTRA WIDE ANGLE OPTICS

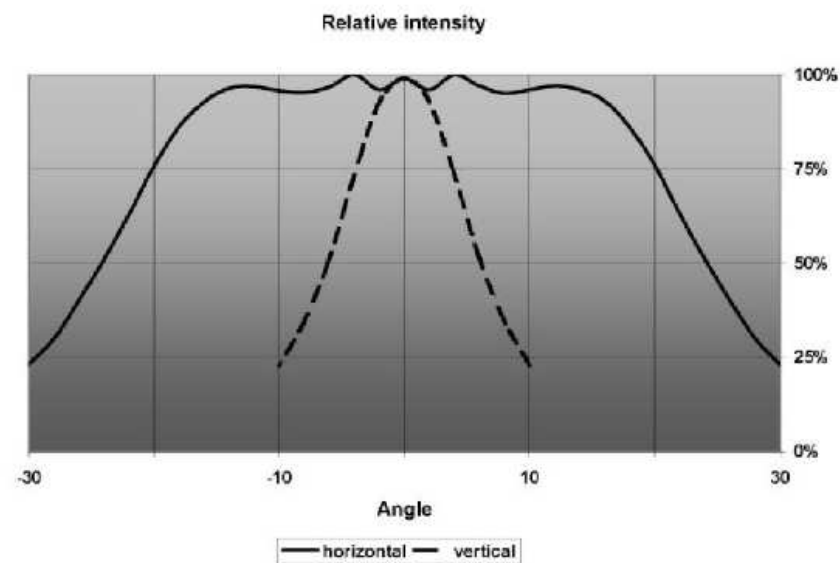

BEAM DISTRIBUTION PLOT OF OVAL ANGLE OPTICS



BEAM DISTRIBUTION LIGHT OUTPUT EXAMPLES

FEATURES

- HIGH EFFICIENCY COMPONENTS USED FOR MAXIMUM ENERGY SAVING.
- LONG LIFE AND RELIABILITY ELIMINATE MAINTENANCE PERIOD FOR 60,000HRS (13 YRS @12 HRS PER DAY).
- DURABLE POWDER COATED IP66 HOUSING WITH TEMPERED GLASS.
- EQUIVALENT TO 250W HALOGEN FLOOD LIGHT WITH UP TO 30 x LONGER LIFE EXPECTANCY.



TOLERANCE/ SCALE UOS
 LINEAR ±0.1
 ANGULAR ±1°
 ORIGINAL SCALE NA

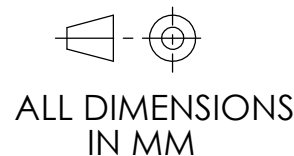

DRN: RE
 DATE:05/01/11
 CHK1: RW
 CHK2: NJO

11/04/12
NON-MAINTAINED COPY

DRAWING NOSHEET MODEL NAME ISSUE
SPL8801 5 OF 6 ASS8800 6

LOW PROFILE LED FLOODLIGHT



Marl International Limited
 Marl Business Park
 Ulverston
 Cumbria
 LA12 9BN
 t: +44 (0) 1229 582430
 f: +44 (0) 1229 585155
 e: sales@marl.co.uk
 w: www.marl.co.uk

ISSUE	MODIFICATION	DRN	DATE
1	ORIGINAL ISSUE	RE	05/01/11
2	035/11	RW	20/05/11
3	074/11	GR	14/09/11
4	102/11	RW	17/11/11
5	107/11	DT	22/12/11
6	025/12	DT	19/03/12

RELUX SIMULATION EXAMPLES FOR MEDIUM AND WIDE ANGLE VERSIONS

**11/04/12
 NON-MAINTAINED
 COPY**



PHOTOMETRIC IMAGE OF MEDIUM OPTIC LED FLOODLIGHT

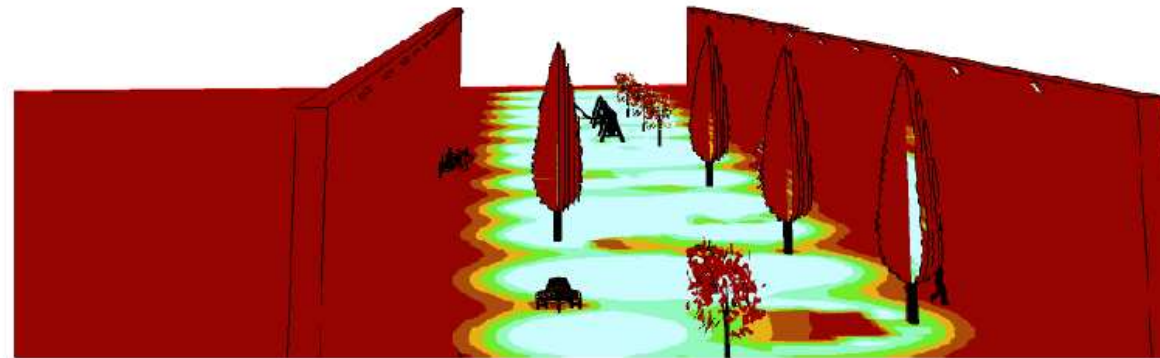

Illuminance [lx]

ILLUMINANCE LEVELS OF PHOTOMETRIC SIMULATION



PHOTOMETRIC IMAGE OF WIDE OPTIC LED FLOODLIGHT

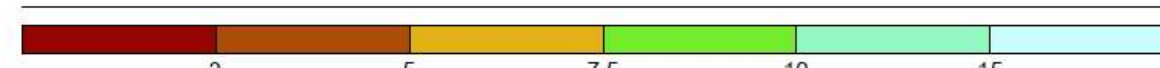
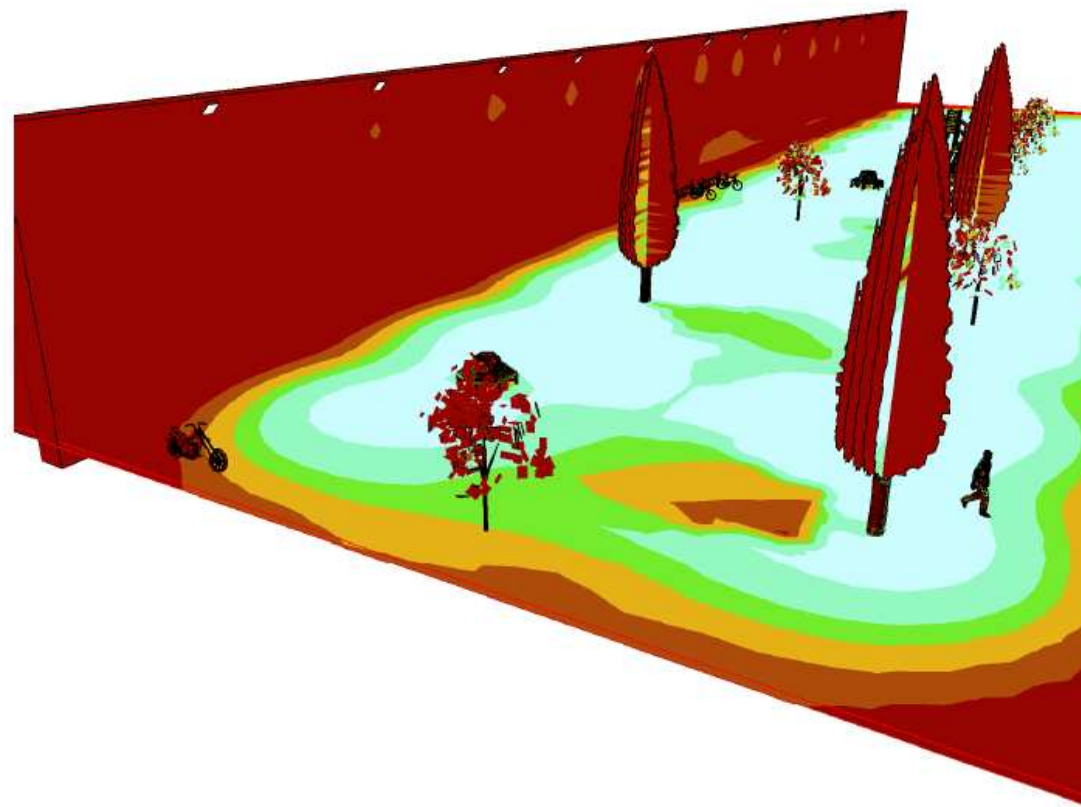

Illuminance [lx]

FEATURES

- HIGH EFFICIENCY COMPONENTS USED FOR MAXIMUM ENERGY SAVING.
- LONG LIFE AND RELIABILITY ELIMINATE MAINTENANCE PERIOD FOR 60,000HRS (13 YRS @12 HRS PER DAY).
- DURABLE POWDER COATED IP66 HOUSING WITH TEMPERED GLASS.
- EQUIVALENT TO 250W HALOGEN FLOOD LIGHT WITH UP TO 30 x LONGER LIFE EXPECTANCY.

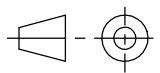

TOLERANCE/ SCALE UOS	
LINEAR	±0.1
ANGULAR	±1°
ORIGINAL SCALE	NA

 ALL DIMENSIONS
 IN MM

DRN:	RE
DATE:	05/01/11
CHK1:	RW
CHK2:	NJO

DRAWING NOSHEET MODEL NAME ISSUE
SPL8801 6 OF 6 ASS8800 6

LOW PROFILE LED FLOODLIGHT



Marl International Limited
Marl Business Park
Ulverston
Cumbria
LA12 9BN
t: +44 (0) 1229 582430
f: +44 (0) 1229 585155
e: sales@marl.co.uk
w: www.marl.co.uk

ISSUE	MODIFICATION	DRN	DATE
1	ORIGINAL ISSUE	RE	05/01/11
2	035/11	RW	20/05/11
3	074/11	GR	14/09/11
4	102/11	RW	17/11/11
5	107/11	DT	22/12/11
6	025/12	DT	19/03/12

LIFE EXPECTANCY INFORMATION

LIGHT DEGRADATION

Testing has shown the light output degradation over time is negligible. These results are detailed below:

Test Method.

All light readings taken on axis at a distance of 3m from the light fixture in a controlled test environment.

Lux Readings:

0.5hrs	1,929lx
3hrs	1,933lx
6hrs	1,934lx
8hrs	1,933lx.

LED LIFE INFORMATION

The Osram Golden Dragon Plus LEDs incorporated in the 748 Series Floodlight has an L70 light degradation figure of 50,000hrs minimum up to 100,000hrs maximum depending on the operating conditions. See graphs below from Osram for further info (Note LEDs are operated at 0.83A with Ts of ~65°C).

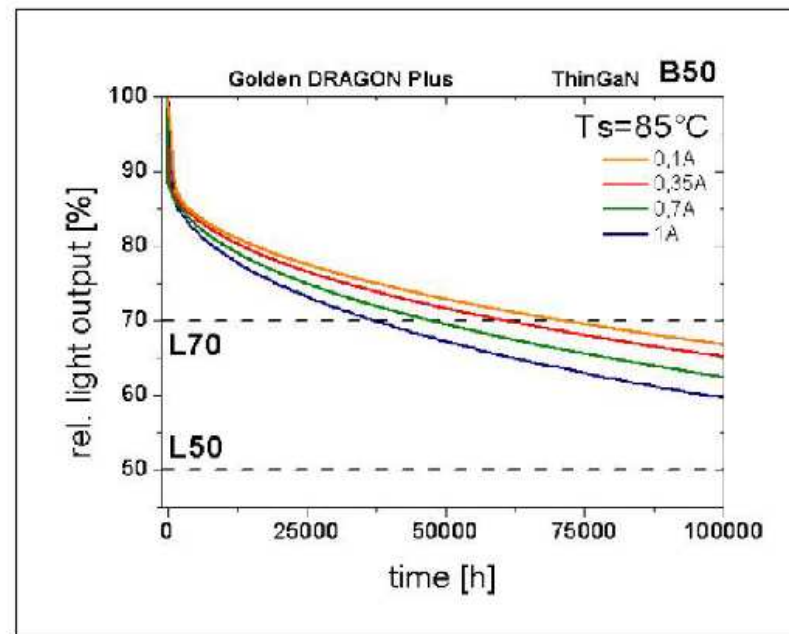
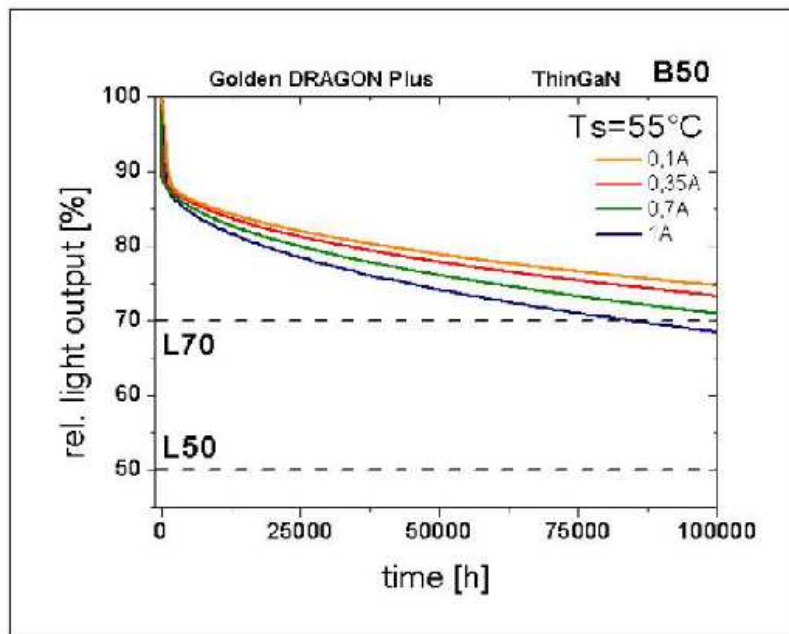

PSU LIFE INFORMATION

The Demonstrated Mean Time Between Failure (DMTBF) of the PSU is 50,000hrs at a case temp of 70°C. The actual measured case temp inside the floodlight is ~45°C under normal conditions; therefore the expected life is 75,000hrs minimum.

FEATURES

- HIGH EFFICIENCY COMPONENTS USED FOR MAXIMUM ENERGY SAVING.
- LONG LIFE AND RELIABILITY ELIMINATE MAINTENANCE PERIOD FOR 60,000HRS (13 YRS @12 HRS PER DAY).
- DURABLE POWDER COATED IP66 HOUSING WITH TEMPERED GLASS.
- EQUIVALENT TO 250W HALOGEN FLOOD LIGHT WITH UP TO 30 x LONGER LIFE EXPECTANCY.



11/04/12
NON-MAINTAINED COPY

TOLERANCE/ SCALE UOS
 LINEAR ±0.1
 ANGULAR ±1°
 ORIGINAL SCALE NA

ALL DIMENSIONS IN MM

DRN: RE
 DATE:05/01/11
 CHK1: RW
 CHK2: NJO