

Cree® XLamp® XB-H LEDs

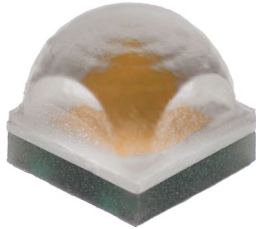

PRODUCT DESCRIPTION

The XLamp® XB-H LED delivers a breakthrough combination of lumen output and efficacy in a small package. Delivering more than 500 lumens at 1.5 A, 25 °C in a 2.45 mm² package, the Cree XB-H LED offers triple the lumen density of competing high-power LEDs to significantly increase the performance of today's lighting designs. The XB-H LED joins a new generation of directionally optimized LEDs that offers the industry's highest optical control factor (OCF), a measurement of how LED size and performance benefit directional lighting applications. High-OCF LEDs enable lighting manufacturers to improve the performance of any lighting design, create smaller and less expensive systems, and develop new lighting solutions that were previously not possible.

FEATURES

- Available in white, outdoor white and 80-, 85- and 90-CRI white
- ANSI-compatible chromaticity bins
- Binned at 85 °C
- Maximum drive current: 1500 mA
- Low thermal resistance: 4 °C/W
- Wide viewing angle: 110°
- Unlimited floor life at ≤ 30 °C/85% RH
- Reflow solderable - JEDEC J-STD-020C
- Electrically neutral thermal path
- RoHS and REACH compliant
- UL® recognized component (E349212)



TABLE OF CONTENTS

Characteristics	2
Flux Characteristics	3
Relative Spectral Power Distribution	4
Relative Flux vs. Junction Temperature	4
Electrical Characteristics	5
Relative Flux vs. Current	5
Relative Chromaticity vs Current and Temperature	6
Typical Spatial Distribution	7
Thermal Design	7
Reflow Soldering Characteristics	8
Notes	9
Mechanical Dimensions	11
Tape and Reel	12
Packaging	13

CHARACTERISTICS

Characteristics	Unit	Minimum	Typical	Maximum
Thermal resistance, junction to solder point	°C/W		4	
Viewing angle (FWHM)	degrees		110	
Temperature coefficient of voltage	mV/°C		-2.2	
ESD withstand voltage (HBM per Mil-Std-883D)	V			8000
DC forward current	mA			1500
Reverse voltage	V			5
Forward voltage (@ 700 mA, 85 °C)	V		2.9	3.3
Forward voltage (@ 1000 mA, 85 °C)	V		3.0	
Forward voltage (@ 1500 mA, 85 °C)	V		3.15	
LED junction temperature	°C			150

FLUX CHARACTERISTICS (T_j = 85 °C)

The following table provides several base order codes for XLamp XB-H LEDs. It is important to note that the base order codes listed here are a subset of the total available order codes for the product family. For more order codes, as well as a complete description of the order-code nomenclature, please consult the XLamp XB LED Family Binning and Labeling document.

Color	CCT Range		Minimum Luminous Flux @ 700 mA			Calculated Minimum Luminous Flux (lm)** @ 85 °C		Order Code
	Min.	Max.	Group	Flux (lm) @ 85 °C	Flux (lm) @ 25 °C*	1.0 A	1.5 A	
Cool White	5000 K	8300 K	T6	280	322	372	499	XBHAWT-00-0000-000LT60E1
			T5	260	299	345	463	XBHAWT-00-0000-000LT50E1
			T4	240	276	318	428	XBHAWT-00-0000-000LT40E1
			T3	220	253	292	392	XBHAWT-00-0000-000LT30E1
Outdoor White	3200 K	5300 K	T6	280	322	372	499	XBHAWT-00-0000-0000T60E3
			T5	260	299	345	463	XBHAWT-00-0000-0000T50E3
			T4	240	276	318	428	XBHAWT-00-0000-0000T40E3
			T3	220	253	292	392	XBHAWT-00-0000-0000T30E3
Neutral White	3700 K	5300 K	T5	260	299	345	463	XBHAWT-00-0000-000LT50E4
			T4	240	276	318	428	XBHAWT-00-0000-000LT40E4
			T3	220	253	292	392	XBHAWT-00-0000-000LT30E4
80-CRI Minimum White	2600 K	4300 K	T4	240	276	318	428	XBHAWT-00-0000-000HT40E5
			T3	220	253	292	392	XBHAWT-00-0000-000HT30E5
Warm White	2600 K	3700 K	T4	240	276	318	428	XBHAWT-00-0000-0000T40E7
			T3	220	253	292	392	XBHAWT-00-0000-0000T30E7
			T2	200	230	265	356	XBHAWT-00-0000-0000T20E7
85-CRI Minimum White	2600 K	3200 K	T2	200	230	265	356	XBHAWT-00-0000-000PT20E7
			S6	182	209	242	324	XBHAWT-00-0000-000PS60E7
			S5	172	198	228	306	XBHAWT-00-0000-000PS50E7
90-CRI Minimum White	2600 K	3200 K	S6	182	209	242	324	XBHAWT-00-0000-000US60E7
			S5	172	198	228	306	XBHAWT-00-0000-000US50E7
			S4	164	186	218	292	XBHAWT-00-0000-000US40E7

Notes:

- Cree maintains a tolerance of $\pm 7\%$ on flux and power measurements, ± 0.005 on chromaticity (CCx, CCy) measurements and ± 2 on CRI measurements. See the Measurements section (page 9).
- Typical CRI for Cool White (5000 K - 8300 K CCT) is 70.
- Typical CRI for Neutral White (3700 K - 5300 K CCT) is 75.
- Typical CRI for Warm White (2600 K - 3700 K CCT) is 80.
- * Flux values @ 25 °C are calculated and for reference only.
- ** Calculated flux values at 1 A and 1.5 A are for reference only.

RELATIVE SPECTRAL POWER DISTRIBUTION

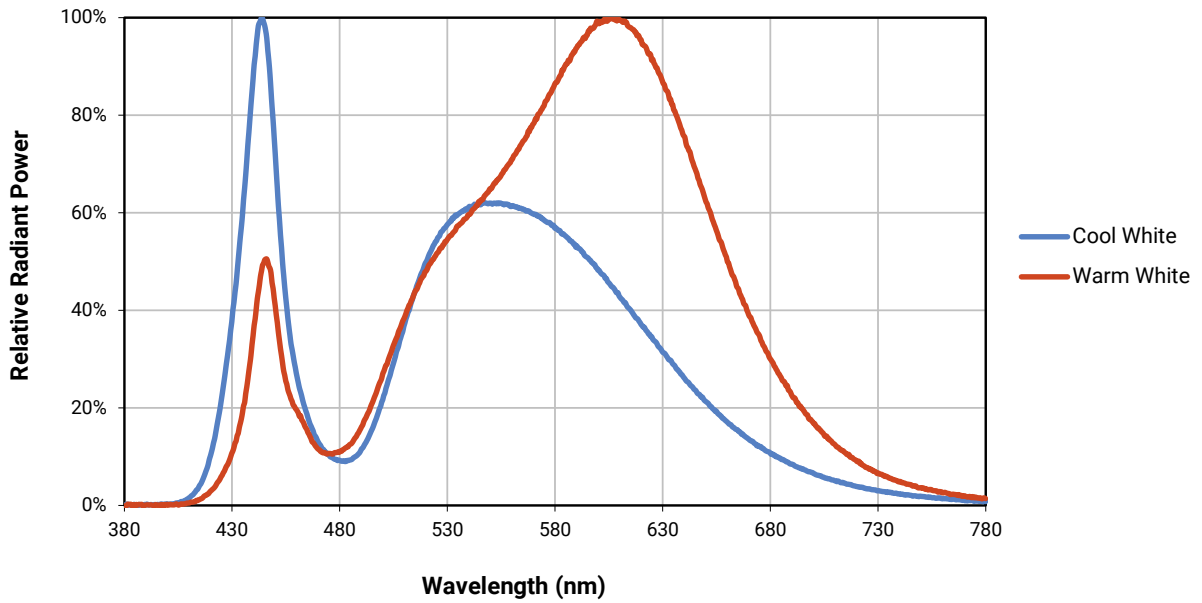

RELATIVE FLUX VS. JUNCTION TEMPERATURE ($I_F = 700$ mA)

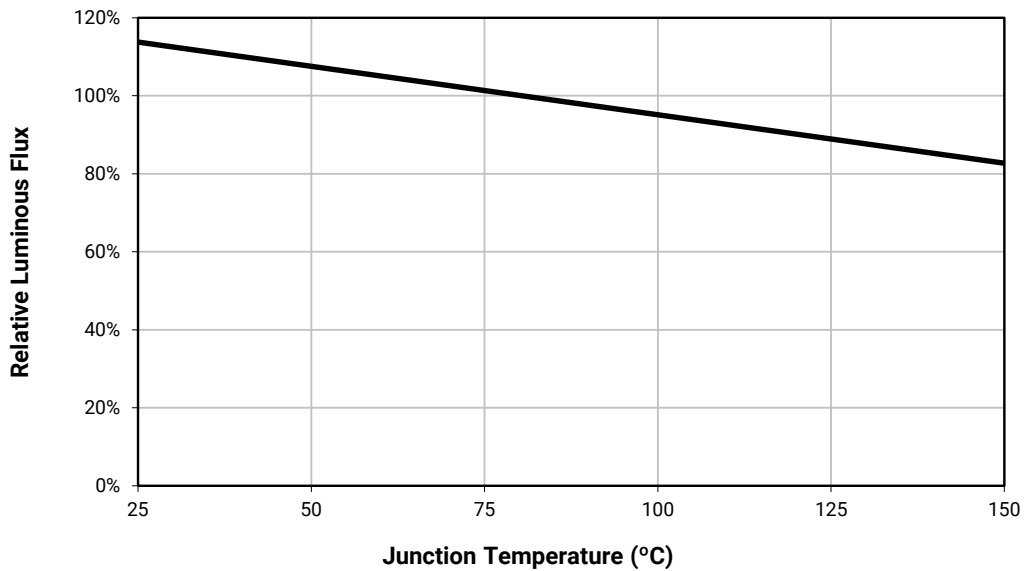

ELECTRICAL CHARACTERISTICS ($T_j = 85\text{ }^\circ\text{C}$)

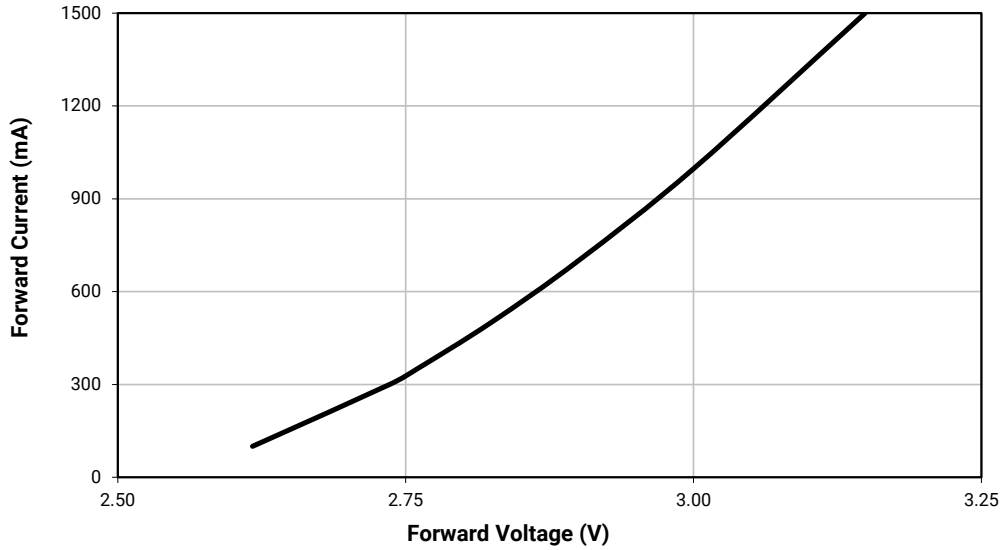

RELATIVE FLUX VS. CURRENT ($T_j = 85\text{ }^\circ\text{C}$)

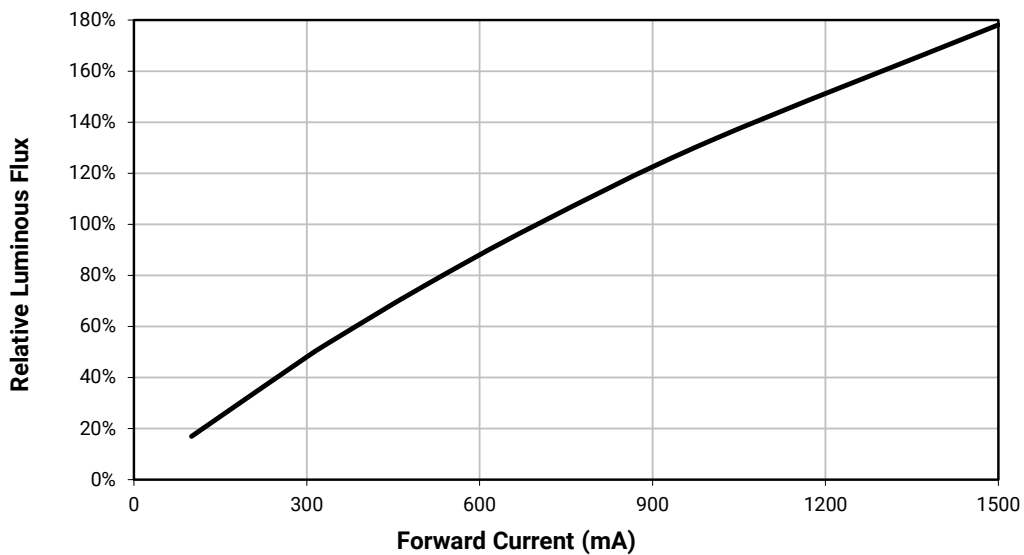

RELATIVE CHROMATICITY VS CURRENT AND TEMPERATURE (WARM WHITE*)

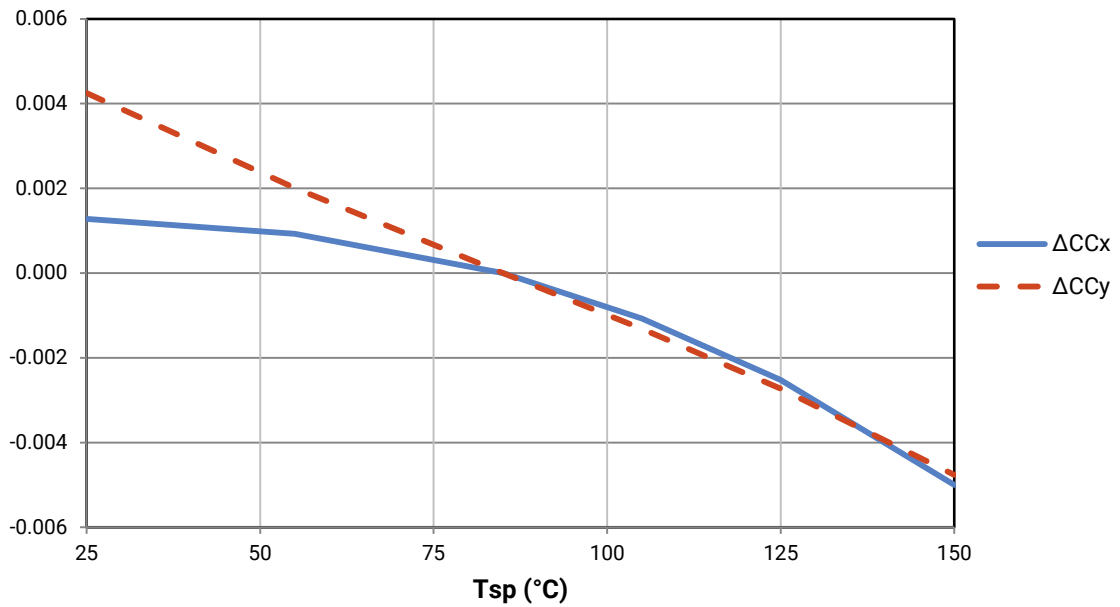
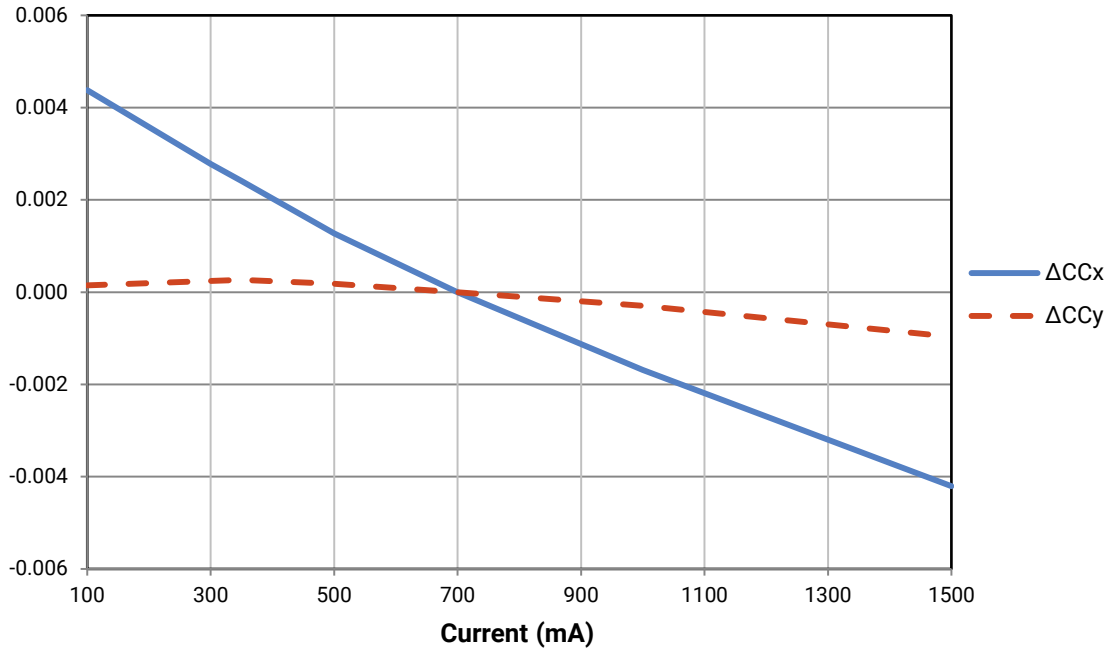

* Warm White XLamp XB-H LEDs have a typical CRI of 80.

TYPICAL SPATIAL DISTRIBUTION

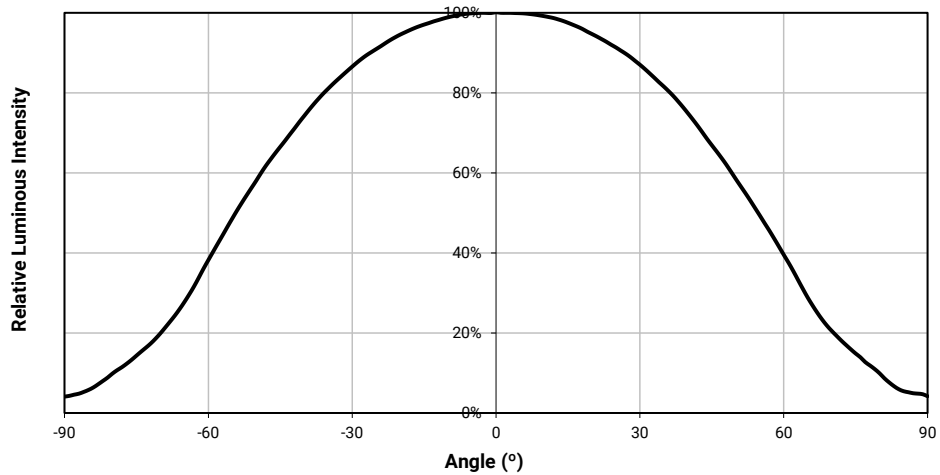

THERMAL DESIGN

The maximum forward current is determined by the thermal resistance between the LED junction and ambient. It is crucial for the end product to be designed in a manner that minimizes the thermal resistance from the solder point to ambient in order to optimize lamp life and optical characteristics.

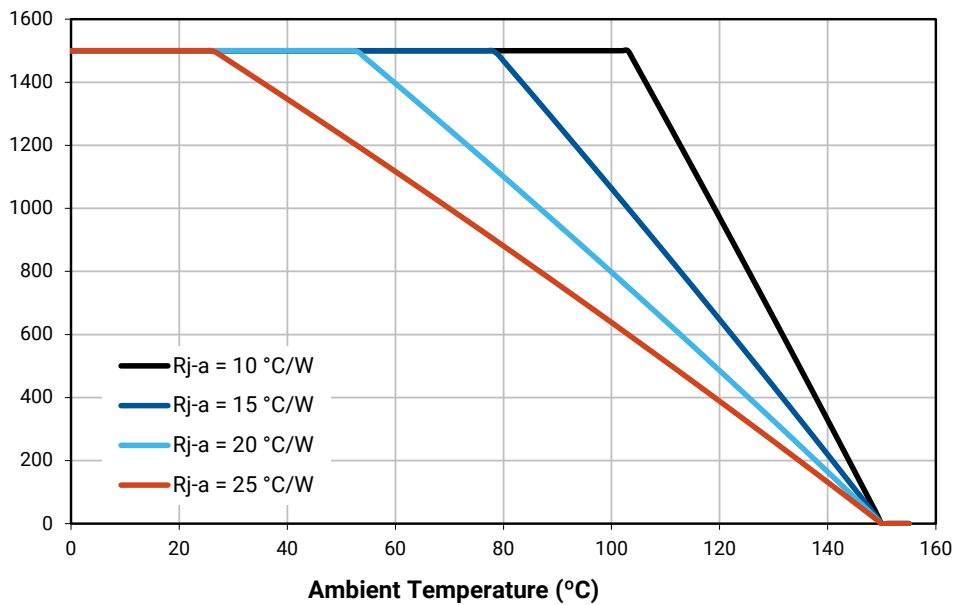

REFLOW SOLDERING CHARACTERISTICS

In testing, Cree has found XLamp XB-H LEDs to be compatible with JEDEC J-STD-020C, using the parameters listed below. As a general guideline, Cree recommends that users follow the recommended soldering profile provided by the manufacturer of the solder paste used.

Note that this general guideline may not apply to all PCB designs and configurations of reflow soldering equipment.



IPC/JEDEC J-STD-020C

Profile Feature	Lead-Free Solder
Average Ramp-Up Rate ($T_{S_{max}}$ to T_P)	1.2 °C/second
Preheat: Temperature Min ($T_{S_{min}}$)	120 °C
Preheat: Temperature Max ($T_{S_{max}}$)	170 °C
Preheat: Time ($t_{S_{min}}$ to $t_{S_{max}}$)	65-150 seconds
Time Maintained Above: Temperature (T_L)	217 °C
Time Maintained Above: Time (t_L)	45-90 seconds
Peak/Classification Temperature (T_P)	235 - 245 °C
Time Within 5 °C of Actual Peak Temperature (t_p)	20-40 seconds
Ramp-Down Rate	1 - 6 °C/second
Time 25 °C to Peak Temperature	4 minutes max.

Note: All temperatures refer to topside of the package, measured on the package body surface.

NOTES

Measurements

The luminous flux, radiant power, chromaticity and CRI measurements in this document are binning specifications only and solely represent product measurements as of the date of shipment. These measurements will change over time based on a number of factors that are not within Cree's control and are not intended or provided as operational specifications for the products. Calculated values are provided for informational purposes only and are not intended as specifications.

Pre-Release Qualification Testing

Please read the [LED Reliability Overview](#) for details of the qualification process Cree applies to ensure long-term reliability for XLamp LEDs and details of Cree's pre-release qualification testing for XLamp LEDs.

Lumen Maintenance

Cree now uses standardized IES LM-80-08 and TM-21-11 methods for collecting long-term data and extrapolating LED lumen maintenance. For information on the specific LM-80 data sets available for this LED, refer to the public [LM-80 results document](#).

Please read the [Long-Term Lumen Maintenance application note](#) for more details on Cree's lumen maintenance testing and forecasting. Please read the [Thermal Management application note](#) for details on how thermal design, ambient temperature, and drive current affect the LED junction temperature.

Moisture Sensitivity

Cree recommends keeping XLamp LEDs in the provided, resealable moisture-barrier packaging (MBP) until immediately prior to soldering. Unopened MBPs that contain XLamp LEDs do not need special storage for moisture sensitivity.

Once the MBP is opened, XLamp XB-H LEDs may be stored as MSL 1 per JEDEC J-STD-033, meaning they have unlimited floor life in conditions of ≤ 30 °C/85% relative humidity (RH). Regardless of storage condition, Cree recommends sealing any unsoldered LEDs in the original MBP.

RoHS Compliance

The levels of RoHS restricted materials in this product are below the maximum concentration values (also referred to as the threshold limits) permitted for such substances, or are used in an exempted application, in accordance with EU Directive 2011/65/EC (RoHS2), as implemented January 2, 2013. RoHS Declarations for this product can be obtained from your Cree representative or from the Product Documentation sections of www.cree.com.

REACH Compliance

REACH substances of very high concern (SVHCs) information is available for this product. Since the European Chemical Agency (ECHA) has published notice of their intent to frequently revise the SVHC listing for the foreseeable future, please contact a Cree representative to insure you get the most up-to-date REACH SVHC Declaration. REACH banned substance information (REACH Article 67) is also available upon request.

NOTES - CONTINUED

UL® Recognized Component

Level 4 enclosure consideration. The LED package or a portion thereof has been investigated as a fire and electrical enclosure per ANSI/UL 8750.

Vision Advisory

WARNING: Do not look at exposed lamp in operation. Eye injury can result. For more information about LEDs and eye safety, please refer to the [LED Eye Safety application note](#).

MECHANICAL DIMENSIONS

Thermal vias, if present, are not shown on these drawings.

All measurements are ± 0.13 mm unless otherwise indicated.

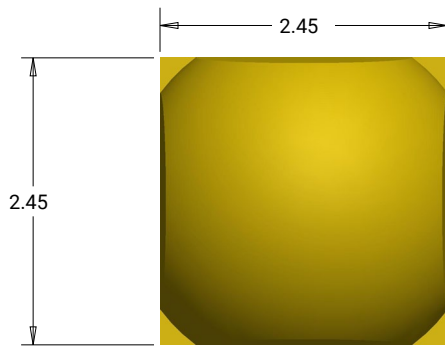

Top View

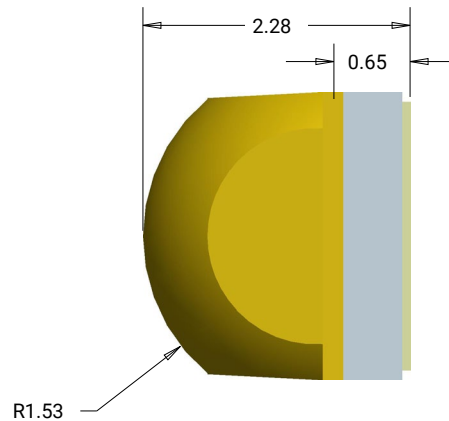

Side View

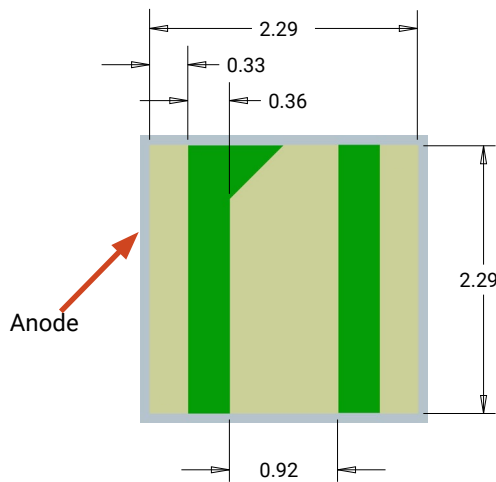

Bottom View

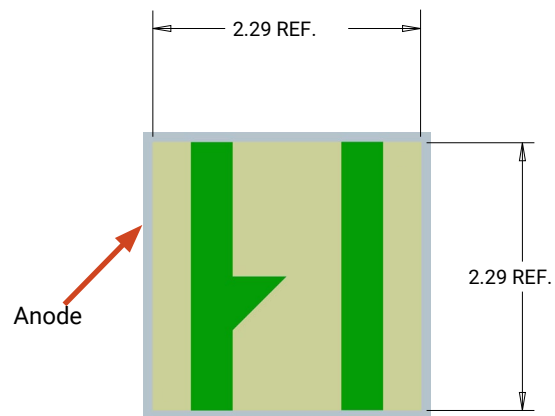

Alternate Bottom View

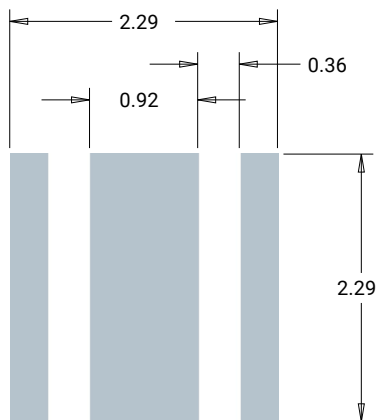

Recommended PCB Solder Pad

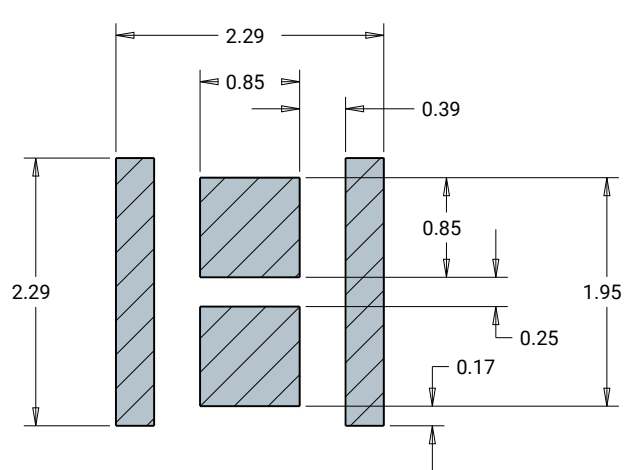

**Recommended Stencil Pattern
(Hatched Area is Opening)**

TAPE AND REEL

All Cree carrier tapes conform to EIA-481D, Automated Component Handling Systems Standard.

Except as noted, all dimensions in mm.

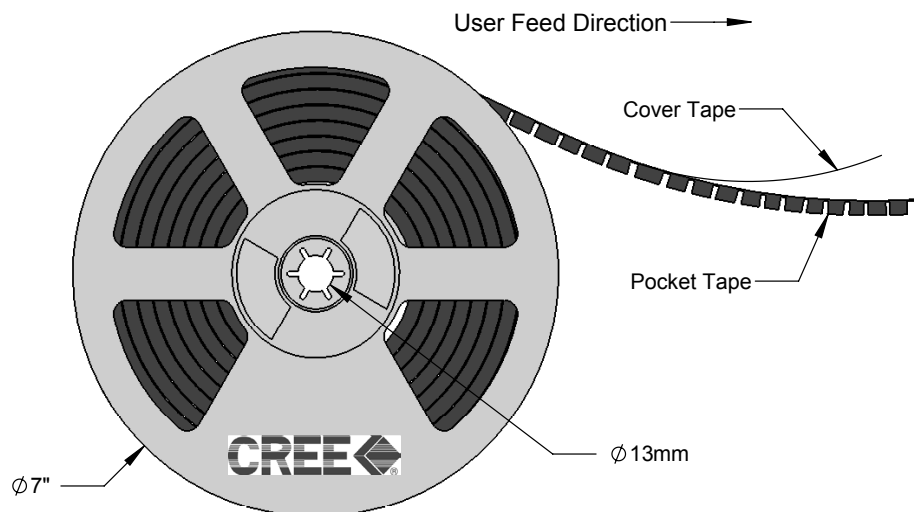
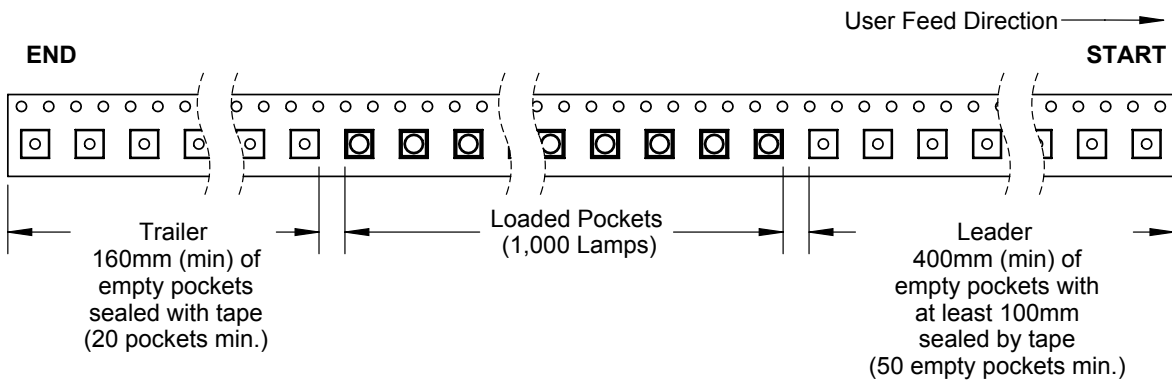
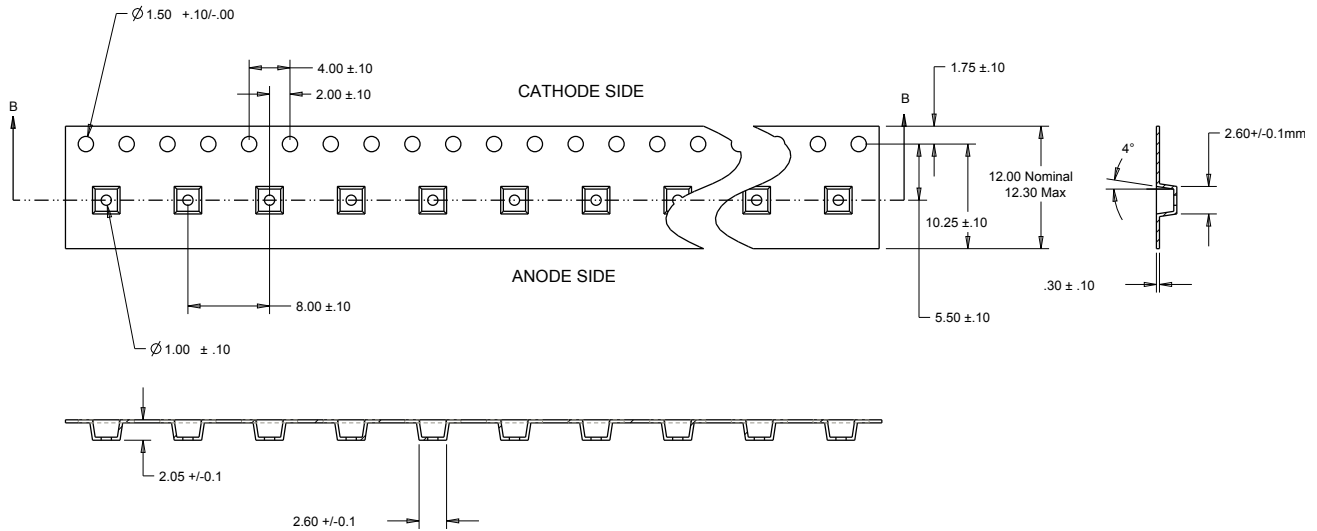

PACKAGING

Unpackaged Reel

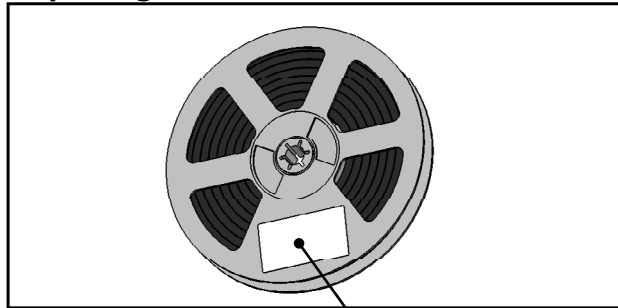

Label with Cree Bin Code,
Quantity, Reel ID

Packaged Reel

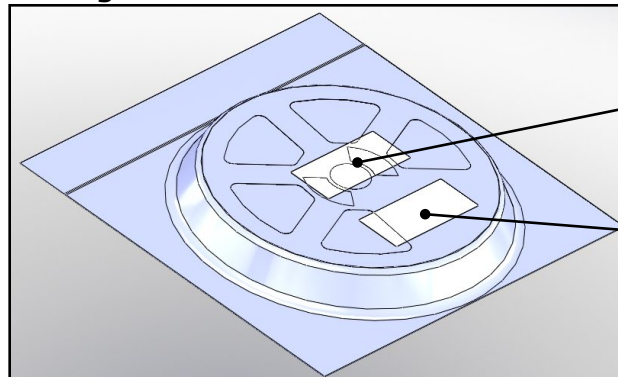

Label with Cree Order Code,
Quantity, Reel ID, PO #

Label with Cree Bin Code,
Quantity, Reel ID

Boxed Reel

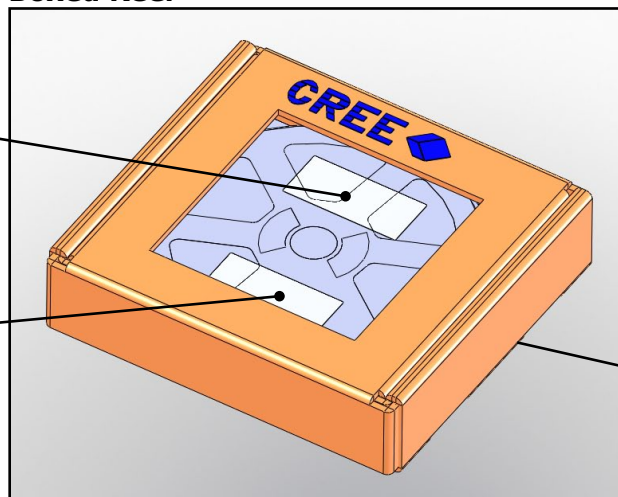

Label with Cree Order Code,
Quantity, Reel ID, PO #

Label with Cree Bin Code,
Quantity, Reel ID

Patent Label
(on bottom of box)