

FEATURES :

- Up to 6 Watt Output Power
- 5 Pin Package
- Low Ripple and Noise
- Regulated Output Types
- 500Vdc Isolation
- MTBF:>1,500,000 hrs
- Operating Temperature:-40°C TO +85°C

Specifications typical at TA=25°C, nominal input voltage and rated output current unless otherwise specified

Part Number	Input Voltage	Output Voltage	Output Current	Efficiency
	Vdc	Vdc	mA	%Typ
82D-05S05RNNL	5	5	1200	60
82D-05S12RNNL	5	12	500	65
82D-05D15RNNL	5	±15	±200	65
82D-12S12RNNL	12	12	500	65
82D-12S15RNNL	12	15	400	65
82D-12D12RNNL	12	±12	±250	65
82D-24S05RNNL	24	5	1200	60
82D-24S15RNNL	24	15	400	65
82D-24D12RNNL	24	±12	±250	65
82D-48S15RNNL	48	15	400	65
82D-48D12RNNL	48	±12	±250	65
82D-48D15RNNL	48	±15	±200	65

Input Specifications

Parameters	Conditions	Min	Typ	Max	Units
Voltage Type				±10	%
Filter	Capacitor				

Output Specifications

Parameters	Conditions	Min	Typ	Max	Units
Voltage Tolerance				±5	%
Short Circuit Protection	Continuous				
Line Regulation				±0.3	%
Load Regulation				±0.5	%
Ripple & Noise	BW=DC To 20MHz			50	mVp-p
Transient response setting time	50% load step change		350		us



DC-DC Converter

82D SERIES

6Watt

0.5KV Isolated

Single & Dual Output

DIL5

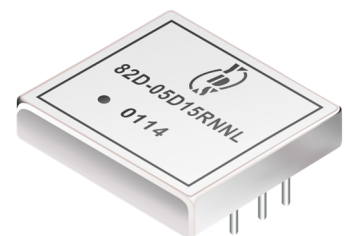

Temperature Derating Graph

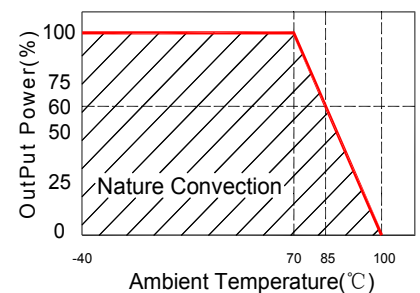

General Specifications

Parameters	Conditions	Min	Typ	Max	Units
Isolation Resistance	500Vdc	1000			MΩ
Switching Frequency			50		KHz
Operating Temperature		-40		+85	°C
Humidity	Non Condensing			95	%
Cooling	Free air Convection				
Case material	Nickel Coated With Non-Conductive Base				
Weight			57		g
Dimensions		50.8x50.8x10.2			mm

Markings and dimensions

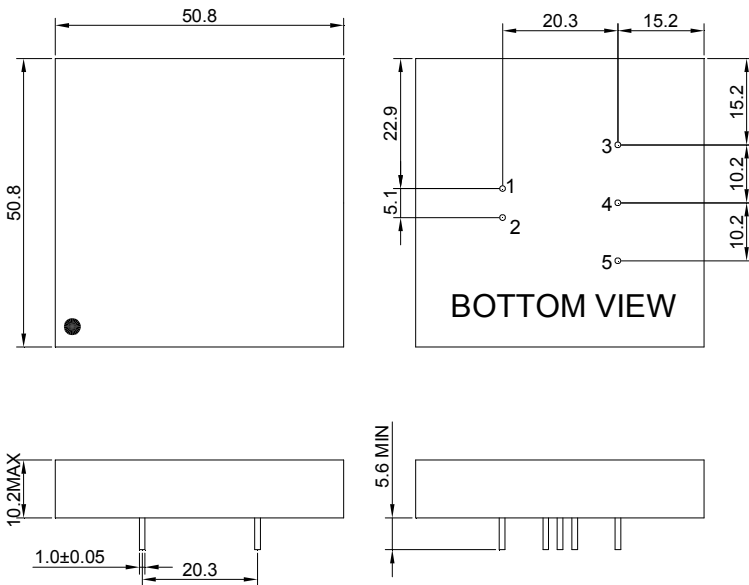

Unit : mm Unless otherwise specified, all tolerances are ±0.25

PIN Connection

PIN	1	2	3	4	5
Single	+Vin	-Vin	+Vout	NO PIN	-Vout
Dual	+Vin	-Vin	+Vout	COM	-Vout

Part Number

82D - 05 D 12 R N NL
A B C D E F G

- A:Series
- B:Input Voltage
- C:Single(S) Dual(D)
- D:Output Voltage
- E:Regulated(R)
- F:Package
- G:RoHS Version

Recommended Test Circuit

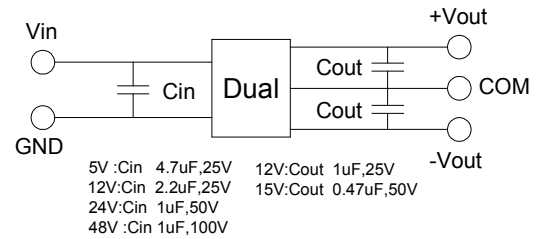
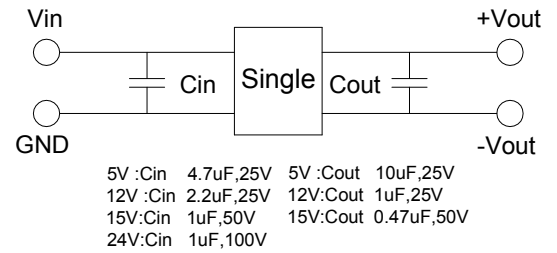

Packaging

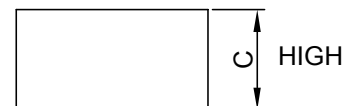
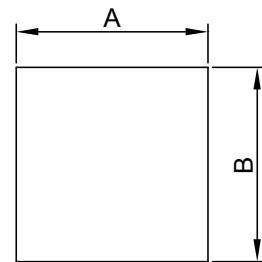

Size(mm)		
A	B	C
51.50	52.30	27.00

