

RED (HIGH EFFICIENCY) HLMP-M200/M201 HLMP-M250/M251
YELLOW HLMP-M300/M301 HLMP-M350/M351
GREEN HLMP-M500/M501 HLMP-M550/M551

PACKAGE DIMENSIONS

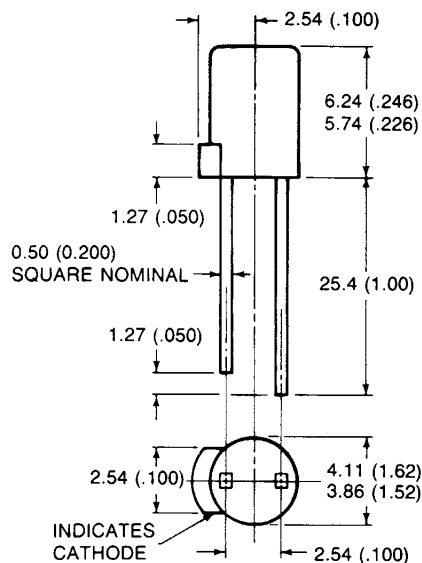

DIMENSIONS IN MILLIMETERS (INCHES)

C3001

DESCRIPTION

Bright colors and a wide viewing angle are the outstanding features of the new 4 mm flat top lamps. The cylindrical shape and flat emitting surface make these lamps particularly well suited for applications requiring high light output in minimal space.

FEATURES

- Replaces Hewlett-Packard devices
- Wide viewing angle
- Excellent for backlighting small areas
- Solid state reliability
- Compact, rugged, lightweight
- Choice of tinted nondiffused and tinted diffused package

PHYSICAL CHARACTERISTICS

PART NUMBER	DESCRIPTION	I _v (mcd)		TEST CONDITION(mA)	TOTAL VIEWING ANGLE
		MIN	TYPE		
HLMP-M200	Red, Diffused	3.4	5.0	20	135
HLMP-M201	Red, Diffused, High Brightness	5.4	7.0	20	
HLMP-M250	Red, Nondiffused	3.4	5.0	10	80
HLMP-M251	Red, Nondiffused, High Brightness	5.4	7.0	10	
HLMP-M300	Yellow, Diffused	3.6	5.0	20	135
HLMP-M301	Yellow, Diffused, High Brightness	5.7	7.0	20	
HLMP-M350	Yellow, Nondiffused	3.6	5.0	10	80
HLMP-M351	Yellow, Nondiffused, High Brightness	5.7	7.0	10	
HLMP-M500	Green, Diffused	4.2	7.0	20	135
HLMP-M501	Green, Diffused, High Brightness	6.7	10.0	20	
HLMP-M550	Green, Nondiffused	4.2	10.0	10	80
HLMP-M551	Green, Nondiffused, High Brightness	6.7	16.0	10	



4mm FLAT TOP LAMPS

ELECTRO-OPTICAL CHARACTERISTICS ($T_A = 25^\circ\text{C}$)											
PARAMETERS	H.E. RED HLMP-M2XX			YELLOW HLMP-M3XX			GREEN HLMP-M5XX			UNITS	TEST CONDITIONS
	MIN	TYP	MAX	MIN	TYP	MAX	MIN	TYP	MAX		
Forward Voltage		2.2	3.0		2.2	3.0		2.3	3.0	V	$I_f = 20\text{ mA}$
Speed of Response		90			90			500		ns	
Peak Wavelength		635			585			565		nm	
Thermal Resistance		120			120			120		$^\circ\text{C}/\text{W}$	Junction to Cathode Lead
Capacitance		20			15			18		pF	$V_r = 0, F = 1\text{ MHz}$
Reverse Breakdown Voltage	5.0			5.0			5.0			V	$I_r = 100\ \mu\text{A}$

ABSOLUTE MAXIMUM RATINGS ($T_A = 25^\circ\text{C}$ unless otherwise specified)				
PARAMETER	H.E. RED HLMP-M2XX	YELLOW HLMP-M3XX	GREEN HLMP-M5XX	UNITS
Power dissipation	135	120	135	mW
Derate linearly from 25°C	1.6	1.6	1.6	$\text{mW}/^\circ\text{C}$
Storage & operating temperature	-55 to +100	-55 to +100	-55 to +100	$^\circ\text{C}$
Lead soldering time at 260°C	5	5	5	sec.
Continuous forward current	35	20	30	mA
Peak forward current $1\ \mu\text{ sec. pulse}$ 0.3% duty cycle	90	60	90	mA
Reverse voltage ($I_r = 100\ \mu\text{A}$)	5	5	5	V
Average forward current	25	20	25	mA
Transient forward current ($10\ \mu\text{ sec pulse}$)	500	500	500	mA

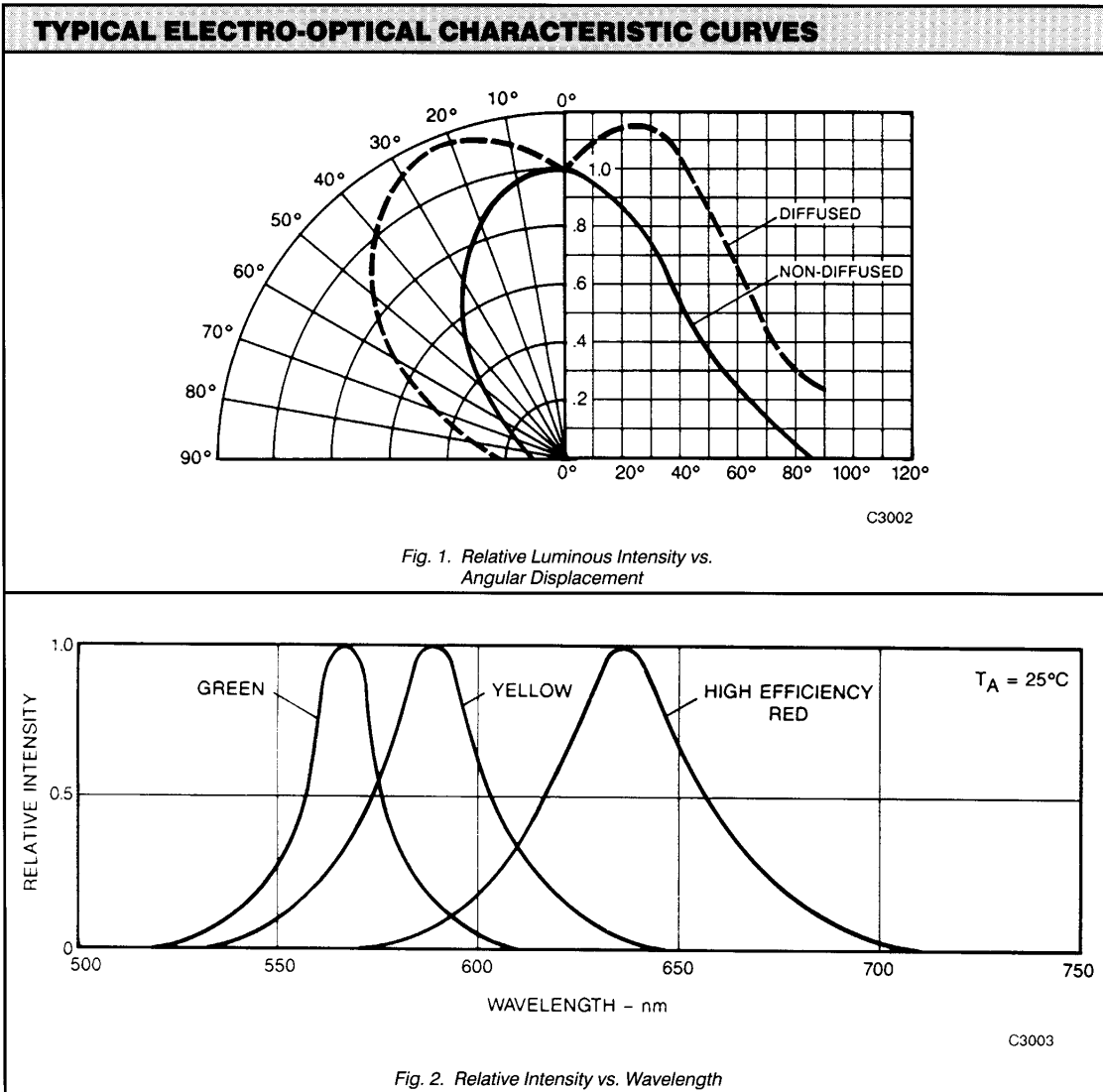

TYPICAL ELECTRO-OPTICAL CHARACTERISTIC CURVES (Cont'd)

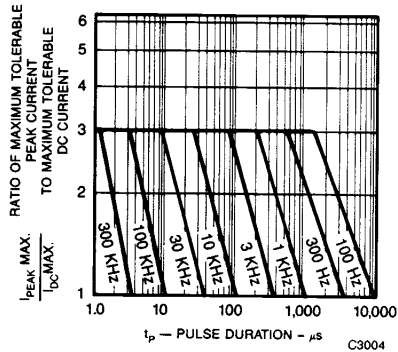

Fig. 3. Maximum Tolerable Peak Current vs. Pulse Duration (I_{DCMAX} as per MAX Ratings)

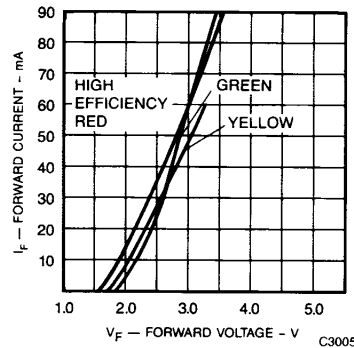

Fig. 4. Forward Current vs. Forward Voltage

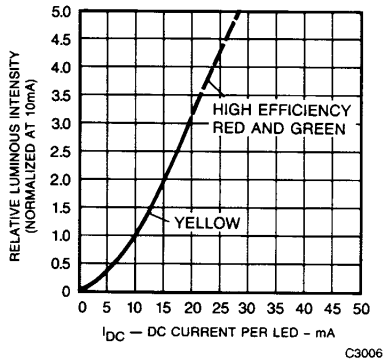

Fig. 5. Relative Luminous Intensity vs. Forward Current. Nondiffused Devices

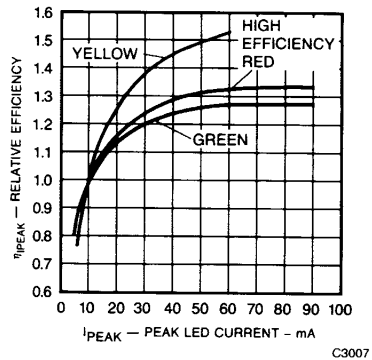

Fig. 6. Relative Efficiency (Luminous Intensity per Unit Current) vs. Peak LED Current. Nondiffused Devices

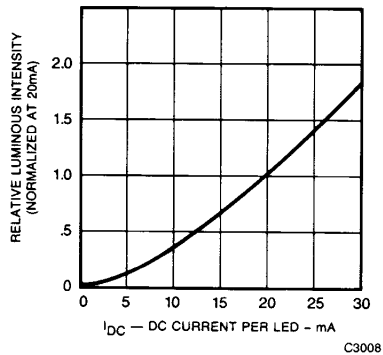

Fig. 7. Relative Luminous Intensity vs. Forward Current. Nondiffused Devices

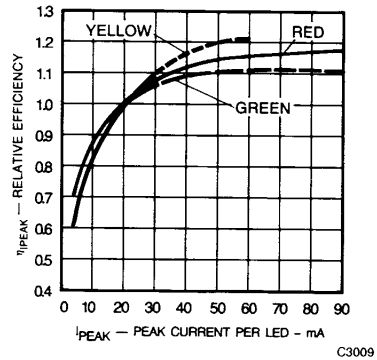

Fig. 8. Relative Efficiency (Luminous Intensity per Unit Current) vs. Peak LED Current. Nondiffused Devices