

Kinghelm®

型号: KH-15EDGRC-3.81-6PG

REV	CONTENT	CHK	DATE
V0.0	CONTENT	SK	2014-11-29

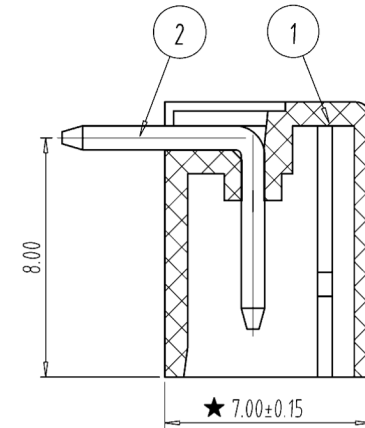
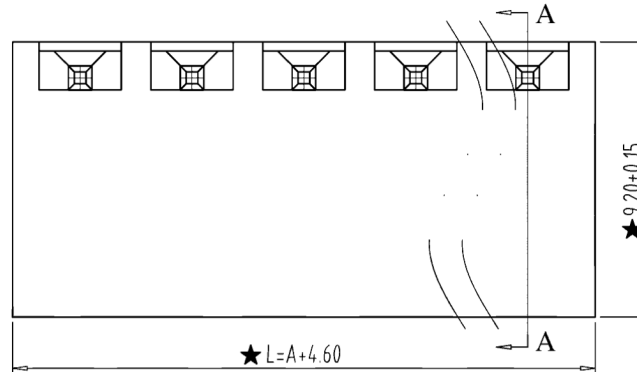
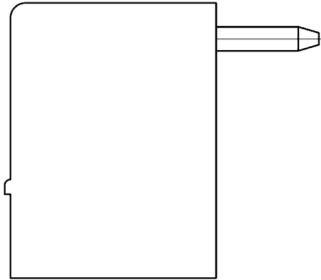

SECTION:A-A

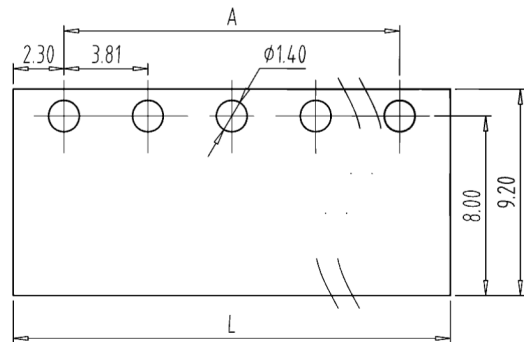

PCB LAYOUT
S=3:1

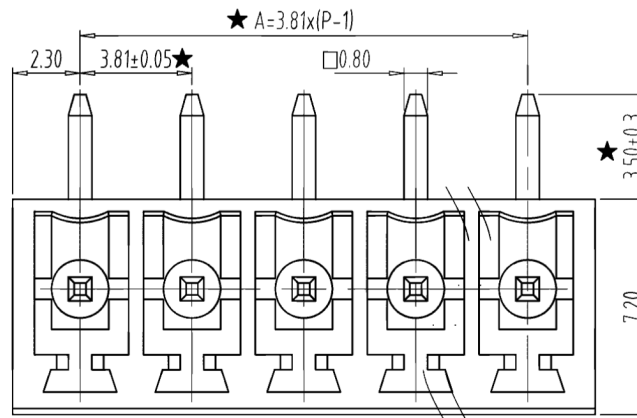

NOTES:

- 1.Rating:300V 8A ,
- 2.Insulation Withstands Voltage: AC2000V/MIN
- 3.Insulation Resistance: 500MΩ or more at DC500V
- 4.Using Temperature Range: -40°C---+105°C
- 5." ★ " is the important dimension

2	PIN	ZF100B0001	P	BRASS	Sn Plated
1	HOUSING	ZF200A0XXXX	1	PA66(V0)	
ITEM	NAME OF PART	NO. OF PART	Q"TY	MATERIAL	NOTE
DWG.	CXL	DATE	14.06.06	SIZE	A4 UNITS mm SHEET/OF 1 / 1
CHK.	DATE			SCALE	4:1 15---3.81(11.0)
APP.	DATE			UWGN0	02-ZBF200RXXPX
深圳市金航标电子有限公司				WWW.BDS666.COM	
KH-15EDGRC-3.81-6PG				0755-83044319	

Total Pitch Tolerances in mm										Nominal dimension range in mm										⊥	=	-	//
over 0 to 30	over 30 to 53	over 53 to 70	over 70 to 90	over 90 to 115	over 115 to 150	over 150 to 250	over 250 to 350	over 350 to 500	over 0 to 30	over 30 to 53	over 53 to 70	over 70 to 90	over 90 to 115	over 115 to 150	over 150 to 200	over 200 to 250	over 250 to 320	over 0 to 10	over 10 to 100	over 100 to 150	over 150		
±0.18	? 0.20	±0.25	±0.3	±0.35	? 0.44	±0.60	±0.70	? 0.85	±0.20	±0.25	±0.30	±0.35	±0.44	±0.55	±0.70	±0.80	±0.90	0.2	0.3	0.3	0.2	0.3	0.5