

**Data sheet | Item number: 2050-301**

2-conductor miniature through terminal block; with operating slots; 1 mm<sup>2</sup>; with test port; side and center marking; End terminal block with mounting flange; Push-in CAGE CLAMP®; 1,00 mm<sup>2</sup>; gray

[www.wago.com/2050-301](http://www.wago.com/2050-301)

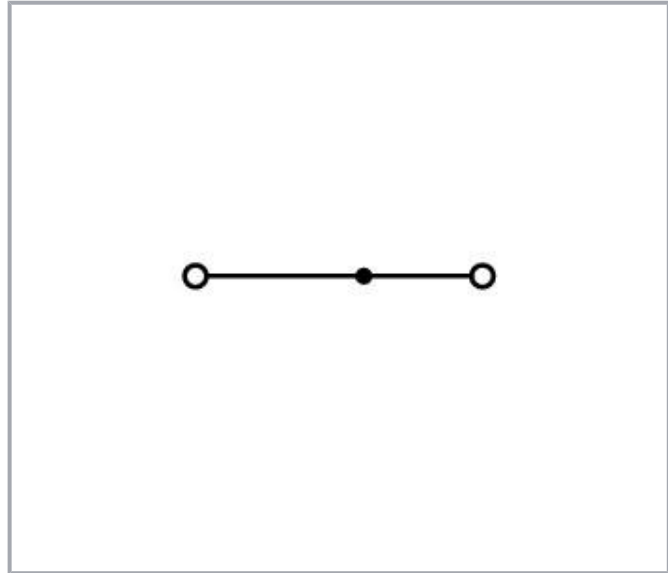
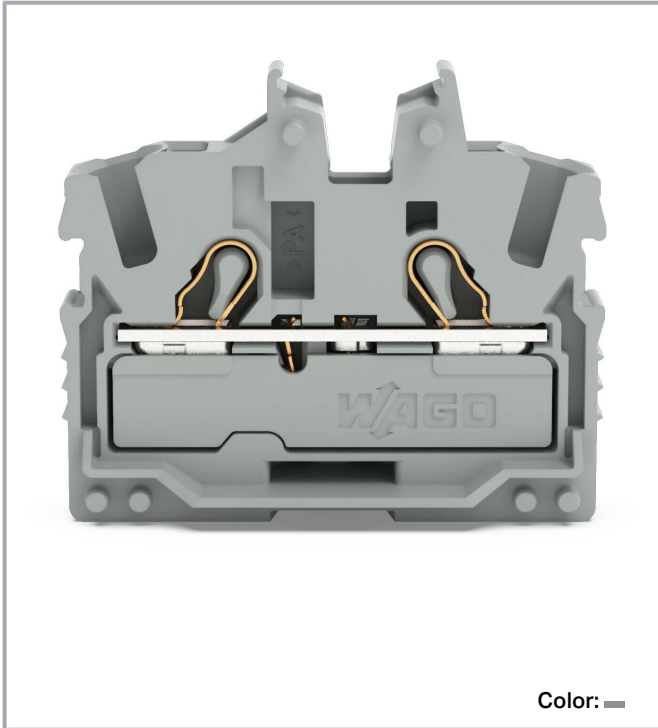

Subject to changes. Please also observe the further product documentation!

WAGO GmbH & Co. KG  
Hansastr. 27  
32423 Minden  
Phone: +49571 887-0 | Fax: +49571 887-169  
Email: [info.de@wago.com](mailto:info.de@wago.com) | Web: [www.wago.com](http://www.wago.com)

Do you have any questions about our products?  
We are always happy to take your call at +49 (571) 887-44222.

Modular terminal blocks and terminal strips with mounting flanges  
 L = (pole no. x 3.5 mm) + 4.3 mm + 6.1 mm

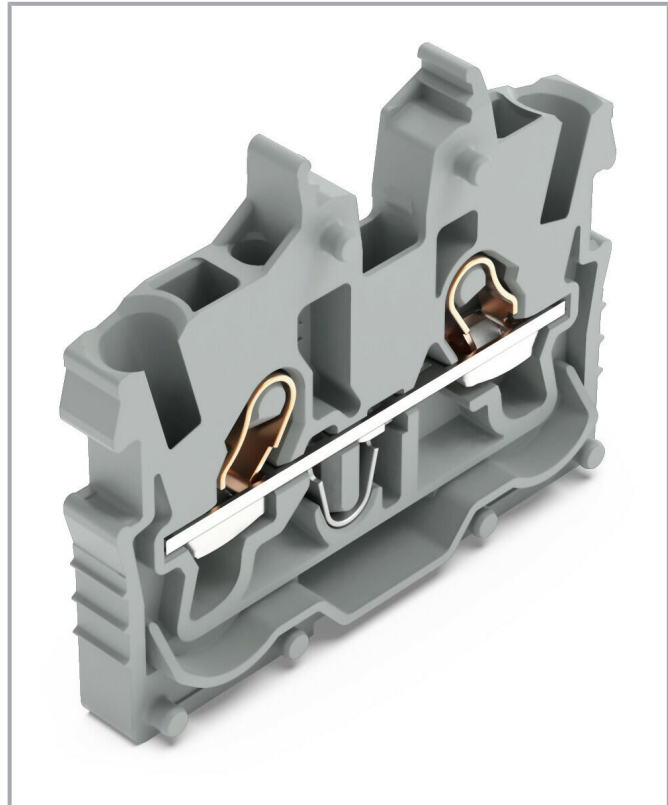
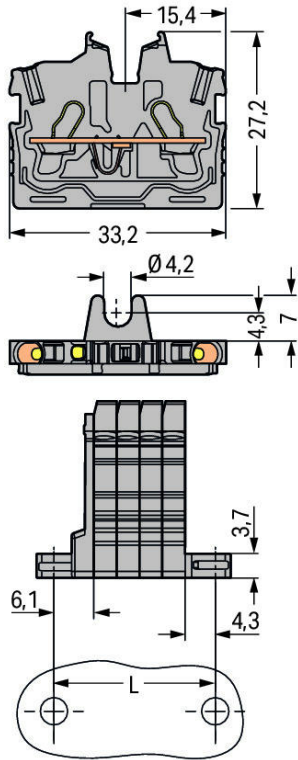

## Data

### Electrical data

#### Ratings per IEC/EN

Ratings per	IEC/EN 60998-2-2
Nominal voltage (III/3)	500 V
Rated surge voltage (III/3)	6 kV
Rated current	13.5 A
Rated current 2	17.5 A
Legend (ratings)	(III / 3) ≙ Overvoltage category III / Pollution degree 3

#### Ratings per UL

Approvals per	UL 1059
Rated voltage UL (Use Group B)	300 V

Subject to changes. Please also observe the further product documentation!

WAGO GmbH & Co. KG  
 Hansastr. 27  
 32423 Minden  
 Phone: +49571 887-0 | Fax: +49571 887-169  
 Email: [info.de@wago.com](mailto:info.de@wago.com) | Web: [www.wago.com](http://www.wago.com)

Do you have any questions about our products?  
 We are always happy to take your call at +49 (571) 887-44222.



Rated current UL (Use Group B)	10 A
Rated voltage UL (Use Group C)	300 V
Rated current UL (Use Group C)	10 A

### Ratings per CSA

Approvals per	C22.2 No 158
Rated voltage CSA (Use Group B)	300 V
Rated current CSA (Use Group B)	10 A
Rated voltage CSA (Use Group C)	300 V
Rated current CSA (Use Group C)	10 A

### Ex information

Ratings per	ATEX: PTB 19 ATEX 1019 U / IECEx: PTB 19.0050U (Ex eb IIC Gb)
Rated voltage EN (Ex e II)	352 V
Rated current (Ex e II)	13.5 A
Rated current (Ex e II) with jumper	12 A

### Connection data

Total number of connection points	2
Total number of potentials	1
Number of levels	1
Number of jumper slots	1

### Connection 1

Connection technology	Push-in CAGE CLAMP®
Actuation type	Push-in Operating tool
Connectable conductor materials	Copper
Nominal cross-section	1 mm <sup>2</sup>
Solid conductor	0.14 ... 1.5 mm <sup>2</sup> / 24 ... 16 AWG
Solid conductor; push-in termination	0.5 ... 1.5 mm <sup>2</sup> / 20 ... 16 AWG
Fine-stranded conductor	0.14 ... 1.5 mm <sup>2</sup> / 24 ... 16 AWG
Fine-stranded conductor; with insulated ferrule	0.14 ... 0.75 mm <sup>2</sup> / 24 ... 18 AWG
Fine-stranded conductor; with ferrule; push-in termination	0.5 ... 0.75 mm <sup>2</sup> / 20 ... 18 AWG
Note (conductor cross-section)	Depending on the conductor characteristic, a conductor with a smaller cross-section can also be inserted via push-in termination.
Strip length	9 ... 11 mm / 0.35 ... 0.43 inch

Subject to changes. Please also observe the further product documentation!

Wiring direction	Front-entry wiring
------------------	--------------------

### Physical data

Width	3.5 mm / 0.138 inch
Height from the surface	27.2 mm / 1.071 inch
Depth	33.2 mm / 1.307 inch

### Mechanical data

Design	horizontal type
Mounting type	Mounting flange
Marking level	Center/side marking

### Material data



Color	gray
Insulation material	Polyamide (PA66)
Flammability class per UL94	V0
Weight	2.5 g

### Commercial data

PU (SPU)	100 Stück
Country of origin	DE
GTIN	4055143968645
Customs tariff number	85369010000

### Approvals / Certificates

#### Ex-Approvals

Logo	Approval	Additional Approval Text	Certificate name
	<b>AEx</b> Underwriters Laboratories Inc.	UL 60079	E185892 (AEx eb IIC resp. Ex eb IIC)
	<b>ATEX</b> Physikalisch Technische Bundesanstalt	EN IEC 60079-0	PTB 19 ATEX 1019 U (II 2G Ex eb IIC Gb or I M 2 Ex eb I Mb)
	<b>CCCEX</b> CQST/CNEx	CNCA-C23-01	2020312313000289

Subject to changes. Please also observe the further product documentation!





**IECEX**  
Physikalisch Technische Bundesanstalt

IEC 60079

IECEX PTB 19.0050  
U (Ex eb IIC Gb or  
EX eb I Mb)

### Country specific Approvals

Logo	Approval	Additional Approval Text	Certificate name
	CCA DEKRA Certification B.V.	EN 60998	NTR NL 7840
	CSA CSA	C22.2 No. 158	80034182
	KEMA/KEUR DEKRA Certification B.V.	EN 60998	71- 113957

### UL-Approvals

Logo	Approval	Additional Approval Text	Certificate name
	cURus Underwriters Laboratories Inc.	UL 1059	E45172

### Counterpart

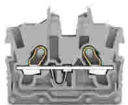

Item no.2050-321

2-conductor miniature through terminal block; with operating slots; 1 mm<sup>2</sup>; with test port; side and center marking;Center terminal block without snap-in mounting foot, without mounting flange; Push-in CAGE CLAMP®; 1,00 mm<sup>2</sup>; gray 321[www.wago.com/2050-](http://www.wago.com/2050-321)

321

### Required accessories

#### End plate

End plate

Subject to changes. Please also observe the further product documentation!

WAGO GmbH &amp; Co. KG

Hansastr. 27

32423 Minden

Phone: +49571 887-0 | Fax: +49571 887-169

Email: [info.de@wago.com](mailto:info.de@wago.com) | Web: [www.wago.com](http://www.wago.com)

Do you have any questions about our products?

We are always happy to take your call at +49 (571) 887-44222.

**Item no.: 2050-381**

End plate; with fixing flange; 1.3 mm thick; gray

[www.wago.com/2050-381](http://www.wago.com/2050-381)

## Optional accessories

### Testing and measuring

#### Testing accessories

**Item no.: 2009-174**

Test plug adapter; for 4 mm Ø test plugs; for testing TOPJOB®S rail-mounted terminal blocks; gray

[www.wago.com/2009-174](http://www.wago.com/2009-174)**Item no.: 2009-182**Testing tap; for max. 2.5 mm<sup>2</sup>; tool-free connection for individual test wires 0.08 - 2.5 mm; gray[www.wago.com/2009-182](http://www.wago.com/2009-182)**Item no.: 210-136**

Test plug; 2 mm Ø; with 500 mm cable; red

[www.wago.com/210-136](http://www.wago.com/210-136)

### Push-in type wire jumper

#### Jumper

**Item no.: 2009-404**Push-in type wire jumper; 0.75 mm<sup>2</sup>; insulated; 110 mm long; gray[www.wago.com/2009-404](http://www.wago.com/2009-404)**Item no.: 2009-402**Push-in type wire jumper; 0.75 mm<sup>2</sup>; insulated; 60 mm long; gray[www.wago.com/2009-402](http://www.wago.com/2009-402)**Item no.: 2009-406**Push-in type wire jumper; 0.75 mm<sup>2</sup>; insulated; 250 mm long; gray[www.wago.com/2009-406](http://www.wago.com/2009-406)

### Tool

#### Operating tool

**Item no.: 210-648**

Operating tool; Blade: 2.5 x 0.4 mm; with a partially insulated shaft; angled; short

[www.wago.com/210-648](http://www.wago.com/210-648)**Item no.: 210-647**

Operating tool; Blade: 2.5 x 0.4 mm; with a partially insulated shaft; multicoloured

[www.wago.com/210-647](http://www.wago.com/210-647)**Item no.: 210-719**

Operating tool; Blade: 2.5 x 0.4 mm; with a partially insulated shaft

[www.wago.com/210-719](http://www.wago.com/210-719)

### Ferrule

#### Ferrule

**Item no.: 216-241**Ferrule; Sleeve for 0.5 mm<sup>2</sup> / 20 AWG; insulated; electro-tin plated; electrolytic copper; gastight crimped; acc. to DIN 46228, Part 4/09.90; white[www.wago.com/216-241](http://www.wago.com/216-241)**Item no.: 216-242**

Subject to changes. Please also observe the further product documentation!

WAGO GmbH &amp; Co. KG

Hansastr. 27

32423 Minden

Phone: +49571 887-0 | Fax: +49571 887-169

Email: [info.de@wago.com](mailto:info.de@wago.com) | Web: [www.wago.com](http://www.wago.com)

Do you have any questions about our products?

We are always happy to take your call at +49 (571) 887-44222.

Ferrule; Sleeve for 0.75 mm<sup>2</sup> / 18 AWG; insulated; electro-tin plated; electrolytic copper; gastight crimped; acc. to DIN 46228, Part 4/09.90; gray

[www.wago.com/216-242](http://www.wago.com/216-242)

**Item no.: 216-243**

Ferrule; Sleeve for 1 mm<sup>2</sup> / AWG 18; insulated; electro-tin plated; electrolytic copper; gastight crimped; acc. to DIN 46228, Part 4/09.90; red

[www.wago.com/216-243](http://www.wago.com/216-243)

**Mounting**

Mounting accessories



**Item no.: 209-123**

Mounting foot with screw; can be screwed on terminal blocks with fixing flange; 6.4 mm wide; gray

[www.wago.com/209-123](http://www.wago.com/209-123)



**Item no.: 209-137**

Mounting adapter; can be used as end stop; 6.5 mm wide; gray

[www.wago.com/209-137](http://www.wago.com/209-137)

**Protective warning marker**

Cover



**Item no.: 2000-115**

Protective warning marker; with high-voltage symbol, black; for 5 terminal blocks; yellow

[www.wago.com/2000-115](http://www.wago.com/2000-115)

**Jumpers**

Marking strip



**Item no.: 2009-110**

Marking strips; for Smart Printer; on reel; not stretchable; plain; snap-on type; white

[www.wago.com/2009-110](http://www.wago.com/2009-110)

Jumper



**Item no.: 2000-408**

Jumper; 8-way; insulated; light gray

[www.wago.com/2000-408](http://www.wago.com/2000-408)



**Item no.: 2000-407**

Jumper; 7-way; insulated; light gray

[www.wago.com/2000-407](http://www.wago.com/2000-407)



**Item no.: 2000-409**

Jumper; 9-way; insulated; light gray

[www.wago.com/2000-409](http://www.wago.com/2000-409)



**Item no.: 2000-408/000-006**

Jumper; 8-way; insulated; blue

[www.wago.com/2000-408/000-006](http://www.wago.com/2000-408/000-006)



**Item no.: 2000-408/000-005**

Jumper; 8-way; insulated; red

[www.wago.com/2000-408/000-005](http://www.wago.com/2000-408/000-005)



**Item no.: 2000-409/000-005**

Jumper; 9-way; insulated; red

[www.wago.com/2000-409/000-005](http://www.wago.com/2000-409/000-005)



**Item no.: 2000-407/000-006**

Jumper; 7-way; insulated; blue

[www.wago.com/2000-407/000-006](http://www.wago.com/2000-407/000-006)

Subject to changes. Please also observe the further product documentation!

WAGO GmbH & Co. KG

Hansastr. 27















32423 Minden

Phone: +49571 887-0 | Fax: +49571 887-169

Email: [info.de@wago.com](mailto:info.de@wago.com) | Web: [www.wago.com](http://www.wago.com)













Do you have any questions about our products?

We are always happy to take your call at +49 (571) 887-44222.

	<b>Item no.: 2000-410</b> Jumper; 10-way; insulated; light gray	<a href="http://www.wago.com/2000-410">www.wago.com/2000-410</a>
	<b>Item no.: 2000-410/000-006</b> Jumper; 10-way; insulated; blue	<a href="http://www.wago.com/2000-410/000-006">www.wago.com/2000-410/000-006</a>
	<b>Item no.: 2000-433/000-005</b> Jumper; from 1 to 3; insulated; red	<a href="http://www.wago.com/2000-433/000-005">www.wago.com/2000-433/000-005</a>
	<b>Item no.: 2000-407/000-005</b> Jumper; 7-way; insulated; red	<a href="http://www.wago.com/2000-407/000-005">www.wago.com/2000-407/000-005</a>
	<b>Item no.: 2000-433/000-006</b> Jumper; from 1 to 3; insulated; blue	<a href="http://www.wago.com/2000-433/000-006">www.wago.com/2000-433/000-006</a>
	<b>Item no.: 2000-410/000-005</b> Jumper; 10-way; insulated; red	<a href="http://www.wago.com/2000-410/000-005">www.wago.com/2000-410/000-005</a>
	<b>Item no.: 2000-435</b> Jumper; from 1 to 5; insulated; light gray	<a href="http://www.wago.com/2000-435">www.wago.com/2000-435</a>
	<b>Item no.: 2000-409/000-006</b> Jumper; 9-way; insulated; blue	<a href="http://www.wago.com/2000-409/000-006">www.wago.com/2000-409/000-006</a>
	<b>Item no.: 2000-436</b> Jumper; from 1 to 6; insulated; light gray	<a href="http://www.wago.com/2000-436">www.wago.com/2000-436</a>
	<b>Item no.: 2000-433</b> Jumper; from 1 to 3; insulated; light gray	<a href="http://www.wago.com/2000-433">www.wago.com/2000-433</a>
	<b>Item no.: 2000-434</b> Jumper; from 1 to 4; insulated; light gray	<a href="http://www.wago.com/2000-434">www.wago.com/2000-434</a>
	<b>Item no.: 2000-402</b> Jumper; 2-way; insulated; light gray	<a href="http://www.wago.com/2000-402">www.wago.com/2000-402</a>
	<b>Item no.: 2000-402/000-006</b> Jumper; 2-way; insulated; blue	<a href="http://www.wago.com/2000-402/000-006">www.wago.com/2000-402/000-006</a>
	<b>Item no.: 2000-403</b> Jumper; 3-way; insulated; light gray	<a href="http://www.wago.com/2000-403">www.wago.com/2000-403</a>
	<b>Item no.: 2000-402/000-005</b> Jumper; 2-way; insulated; red	<a href="http://www.wago.com/2000-402/000-005">www.wago.com/2000-402/000-005</a>

Subject to changes. Please also observe the further product documentation!



	<b>Item no.: 2000-402/000-018</b> Jumper; 2-way; insulated; yellow-green	<a href="http://www.wago.com/2000-402/000-018">www.wago.com/2000-402/000-018</a>
	<b>Item no.: 2000-404</b> Jumper; 4-way; insulated; light gray	<a href="http://www.wago.com/2000-404">www.wago.com/2000-404</a>
	<b>Item no.: 2000-403/000-005</b> Jumper; 3-way; insulated; red	<a href="http://www.wago.com/2000-403/000-005">www.wago.com/2000-403/000-005</a>
	<b>Item no.: 2000-404/000-006</b> Jumper; 4-way; insulated; blue	<a href="http://www.wago.com/2000-404/000-006">www.wago.com/2000-404/000-006</a>
	<b>Item no.: 2000-403/000-006</b> Jumper; 3-way; insulated; blue	<a href="http://www.wago.com/2000-403/000-006">www.wago.com/2000-403/000-006</a>
	<b>Item no.: 2000-404/000-005</b> Jumper; 4-way; insulated; red	<a href="http://www.wago.com/2000-404/000-005">www.wago.com/2000-404/000-005</a>
	<b>Item no.: 2000-405</b> Jumper; 5-way; insulated; light gray	<a href="http://www.wago.com/2000-405">www.wago.com/2000-405</a>
	<b>Item no.: 2000-405/011-000</b> Star point jumper; 3-way; insulated; light gray	<a href="http://www.wago.com/2000-405/011-000">www.wago.com/2000-405/011-000</a>
	<b>Item no.: 2000-405/000-006</b> Jumper; 5-way; insulated; blue	<a href="http://www.wago.com/2000-405/000-006">www.wago.com/2000-405/000-006</a>
	<b>Item no.: 2000-406/000-006</b> Jumper; 6-way; insulated; blue	<a href="http://www.wago.com/2000-406/000-006">www.wago.com/2000-406/000-006</a>
	<b>Item no.: 2000-405/000-005</b> Jumper; 5-way; insulated; red	<a href="http://www.wago.com/2000-405/000-005">www.wago.com/2000-405/000-005</a>
	<b>Item no.: 2000-406</b> Jumper; 6-way; insulated; light gray	<a href="http://www.wago.com/2000-406">www.wago.com/2000-406</a>
	<b>Item no.: 2000-406/000-005</b> Jumper; 6-way; insulated; red	<a href="http://www.wago.com/2000-406/000-005">www.wago.com/2000-406/000-005</a>

Subject to changes. Please also observe the further product documentation!



**Item no.: 2000-406/020-000**  
Delta jumper; insulated; light gray

[www.wago.com/2000-406/020-000](http://www.wago.com/2000-406/020-000)



**Item no.: 2000-437**  
Jumper; from 1 to 7; insulated; light gray

[www.wago.com/2000-437](http://www.wago.com/2000-437)



**Item no.: 2000-438**  
Jumper; from 1 to 8; insulated; light gray

[www.wago.com/2000-438](http://www.wago.com/2000-438)



**Item no.: 2000-439**  
Jumper; from 1 to 9; insulated; light gray

[www.wago.com/2000-439](http://www.wago.com/2000-439)



**Item no.: 2000-440**  
Jumper; from 1 to 10; insulated; light gray

[www.wago.com/2000-440](http://www.wago.com/2000-440)

**Marking accessories**

Marker



**Item no.: 2009-113**  
WMB-Inline; for Smart Printer; 2300 pieces on roll; plain; snap-on type; white

[www.wago.com/2009-113](http://www.wago.com/2009-113)



**Item no.: 2009-113/000-002**  
WMB-Inline; for Smart Printer; 2300 pieces on roll; plain; snap-on type; yellow

[www.wago.com/2009-113/000-002](http://www.wago.com/2009-113/000-002)



**Item no.: 2009-113/000-012**  
WMB-Inline; for Smart Printer; 2300 pieces on roll; plain; snap-on type; orange

[www.wago.com/2009-113/000-012](http://www.wago.com/2009-113/000-012)



**Item no.: 2009-113/000-007**  
WMB-Inline; for Smart Printer; 2300 pieces on roll; plain; snap-on type; gray

[www.wago.com/2009-113/000-007](http://www.wago.com/2009-113/000-007)



**Item no.: 2009-113/000-005**  
WMB-Inline; for Smart Printer; 2300 pieces on roll; plain; snap-on type; red

[www.wago.com/2009-113/000-005](http://www.wago.com/2009-113/000-005)



**Item no.: 2009-113/000-017**  
WMB-Inline; for Smart Printer; 2300 pieces on roll; plain; snap-on type; light green

[www.wago.com/2009-113/000-017](http://www.wago.com/2009-113/000-017)



**Item no.: 2009-113/000-006**  
WMB-Inline; for Smart Printer; 2300 pieces on roll; plain; snap-on type; blue

[www.wago.com/2009-113/000-006](http://www.wago.com/2009-113/000-006)



**Item no.: 2009-113/000-024**  
WMB-Inline; for Smart Printer; 2300 pieces on roll; plain; snap-on type; violet

[www.wago.com/2009-113/000-024](http://www.wago.com/2009-113/000-024)

Subject to changes. Please also observe the further product documentation!



**Item no.:** 2009-113/000-023

WMB-Inline; for Smart Printer; 2300 pieces on roll; plain; snap-on type; green

[www.wago.com/2009-113/000-023](http://www.wago.com/2009-113/000-023)



**Item no.:** 793-3501

WMB marking card; as card; plain; snap-on type; white

[www.wago.com/793-3501](http://www.wago.com/793-3501)

Group marker carrier



**Item no.:** 2009-191

Group marker carrier

[www.wago.com/2009-191](http://www.wago.com/2009-191)

## Downloads

### Documentation

#### Additional Information

	pdf 125.0 kB	Download
	pdf 125.0 kB	Download
Technical explanations	pdf 2.2 MB	Download

## CAD/CAE-Data

### CAD data

2D/3D Models 2050-301	URL	Download
-----------------------	-----	----------

### CAE data

ZUKEN Portal 2050-301	URL	Download
EPLAN Data Portal 2050-301	URL	Download
	URL	Download

## Environmental Product Compliance

### Compliance Search

Environmental Product Compliance 2050-301	URL	Download
2-conductor miniature through terminal block; with operating slots; 1 mm <sup>2</sup> ; with test port; side and center marking; End terminal block with mounting flange; Push-in CAGE CLAMP®; 1,00 mm <sup>2</sup> ; gray		

Subject to changes. Please also observe the further product documentation!

## Installation Notes

### Installation

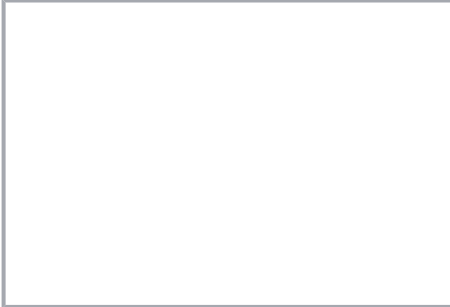

### Conductor termination

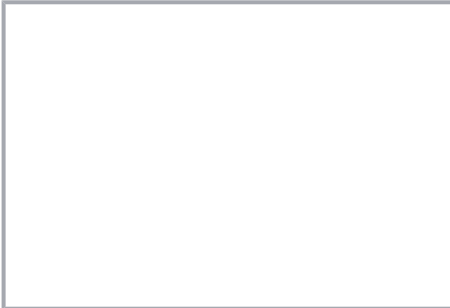

Insert solid conductors via push-in termination.

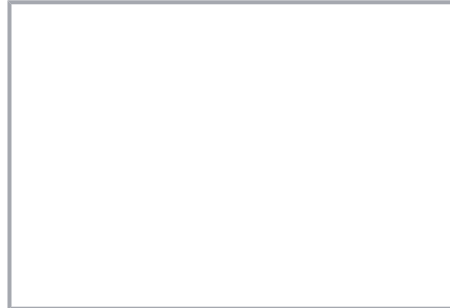

Insert ferruled conductors via push-in termination.

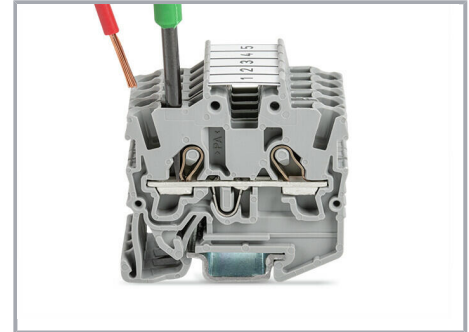

Insert fine-stranded conductors via operating tool.

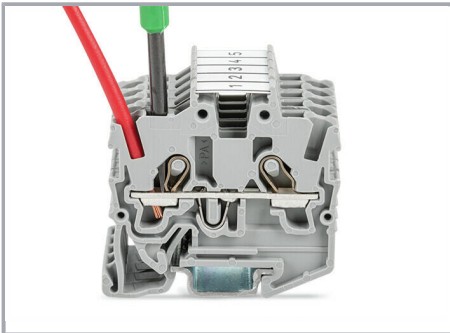

Remove all conductors via operating tool.

### Commoning

Subject to changes. Please also observe the further product documentation!



Insert a jumper (delta jumper) and push down until it hits the backstop (picture shows terminal blocks with push-buttons).

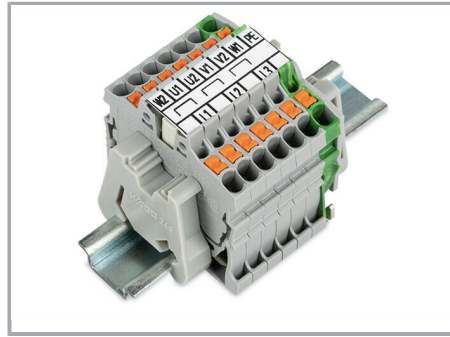

Marking strip (2009-110) inserted in the marking slot with jumper symbols of the inserted jumper (picture shows terminal blocks with push-buttons)

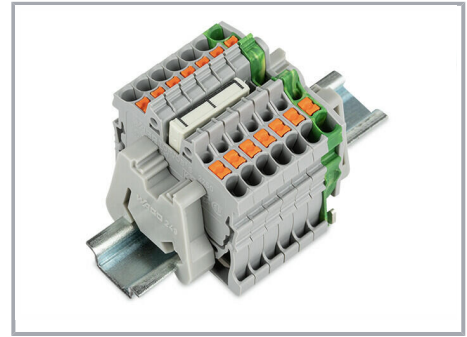

Insert a jumper (star point jumper) and push down until it hits the backstop (picture shows terminal blocks with push-buttons).

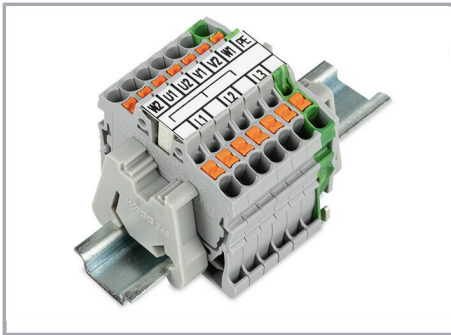

Marking strip (2009-110) inserted in the marking slot with jumper symbols of the inserted jumper (2000-405/011-000 Delta Jumper) (picture shows terminal blocks with push-buttons)

### Testing



Testing with a 2 mm Ø 210-136 Test Plug (max. 42 V).

### Installation

Subject to changes. Please also observe the further product documentation!



Mounting and securing a terminal strip directly to the plate via screw-type flanges (picture shows terminal blocks with push-buttons).



Terminal strip; with mounting flanges; screw mounting (picture shows terminal blocks with push-buttons)

### Marking

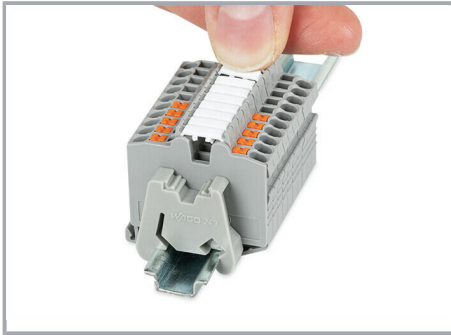

Snapping a WMB marking strip into a marker slot.

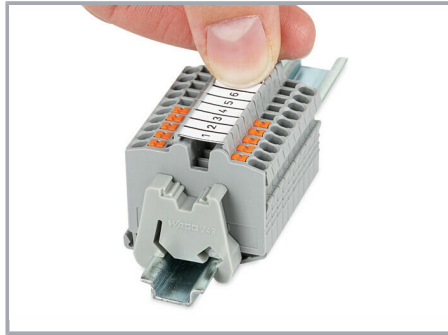

Snapping a marking strip (2009-110) into a marker slot.

### Product family

#### TOPJOB® S

TOPJOB® S: In various industrial applications and modern building installations, WAGO's wide and versatile range of rail-mount terminal blocks provides more than just reliable electrical connections.

[Show all products from the family](#)

Subject to changes. Please also observe the further product documentation!