

PLEASE CHECK WWW.MOLEX.COM FOR LATEST PART INFORMATION

Part Number: [63892-4300](#)
Status: **Active**
Description: Mini-Mac™ Applicator

Documents:
[RoHS Certificate of Compliance \(PDF\)](#)

General

Product Family	Application Tooling
Series	T9999
Comments	See Tooling Specification (PDF) Above
Function	Crimp
Geographic Area	Global
Level of Automation	Automatic, Semi-Automatic
More Detailed Tech Information	applicationtooling@molex.com
Product Name	Mini-Mac™
Survey	www.molex.com//review/apptool_survey.html
Tool Type	Mini-Mac Applicator
UPC	800756656434

Physical

Net Weight 4892.662/g

Material Info

Reference - Drawing Numbers

Application Tooling Documents [ATS-638924300](#), [TM-638000100](#), [TM-638000100SP](#)

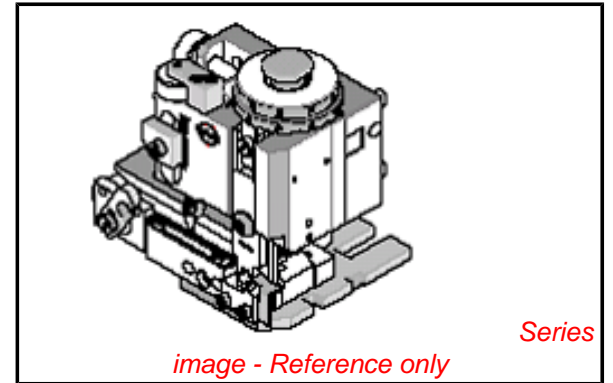

EU RoHS

**ELV and RoHS
Compliant**

REACH SVHC

Not Reviewed

Low-Halogen Status

Not Reviewed

China RoHS



**Need more information on product
environmental compliance?**

Email productcompliance@molex.com
 For a multiple part number RoHS Certificate of
 Compliance, [click here](#)

Please visit the [Contact Us](#) section for any
 non-product compliance questions.

Search Parts in this Series

[T9999Series](#)

Use With

Molex TM-3000™: [63801-7200](#) ,
[63801-7300](#) , Molex TM-4000™:
[63801-7600](#) , Molex TM-2000™:
[63800-8300](#) , [63800-8400](#) , and Most
 Industry Standard Presses or Wire Process
 Machines