

Vertical Mount Inductors

Model HM11

Electrical / Environmental

- Operating Temperature Range -40°C to +105°C
- Temperature Rise, Maximum 45°C
- RoHS Compliant

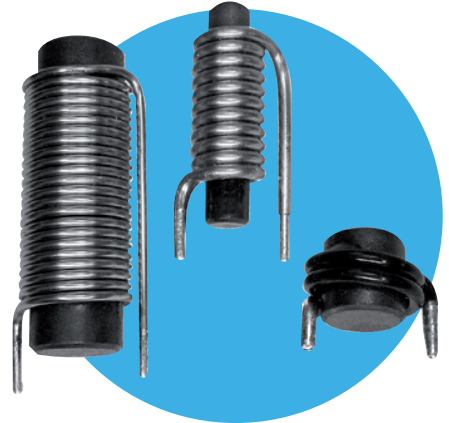

Outline Dimensions (Inch / mm) / Schematic

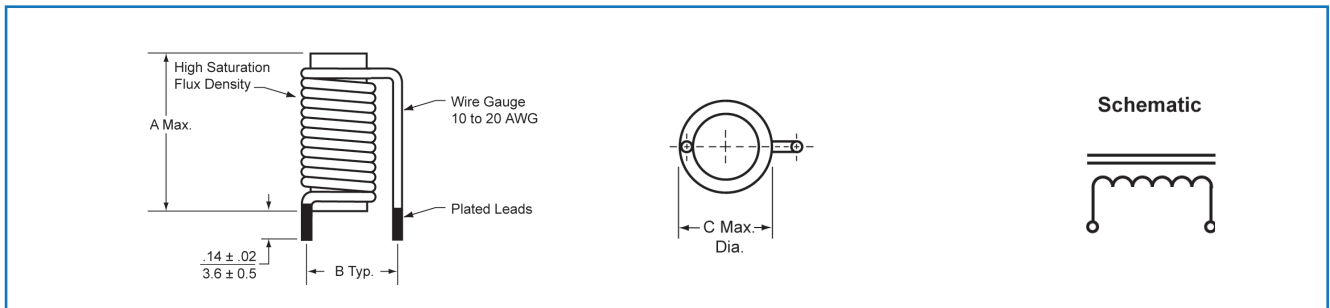

Specifications / Packaging

Part number	Core Size	Wire Gauge AWG mm ⁽¹⁾	Inductance μH @ 10 kHz $\pm 25\%$	DCR Max. m Ω	I_{SAT} DC Amps Approx.	Max. Current DC Amps		Mechanical Outline Dimensions: Inches (mm)			Carton Box Quantity (Units)
						at 35°C Rise	at 45°C Rise	A	B	C	
HM11-11001LF	10 X 40	10 (2.59)	4.46	2.0	48	23.5	26.5	1.65 (42)	.75 (19.0)	.63 (16.0)	250
HM11-11302LF	10 X 35	13 (1.83)	7.20	4.5	36	13.0	15.0	1.46 (37)	.65 (16.5)	.57 (14.5)	300
HM11-11503LF	10 X 35	15 (1.45)	11.00	8.1	28	10.5	12.0	1.46 (37)	.60 (15.2)	.54 (13.7)	300
HM11-11804LF	10 X 35	18 (1.02)	21.00	21.4	20	7.0	8.0	1.46 (37)	.55 (14.0)	.50 (12.8)	300
HM11-12005LF	10 X 35	20 (0.81)	34.00	43.0	16	5.5	6.5	1.46 (37)	.55 (14.0)	.49 (12.4)	300
HM11-21001LF	10 X 25	10 (2.59)	1.40	1.2	85	25.0	28.0	1.06 (27)	.75 (19.0)	.63 (16.0)	300
HM11-21302LF	10 X 25	13 (1.83)	3.30	3.4	60	14.0	16.0	1.06 (27)	.65 (16.5)	.57 (14.5)	300
HM11-21503LF	10 X 25	15 (1.45)	5.00	5.8	46	11.5	13.5	1.06 (27)	.60 (15.2)	.54 (13.7)	300
HM11-21804LF	10 X 25	18 (1.02)	9.30	15.0	30	8.0	9.0	1.06 (27)	.55 (14.0)	.50 (12.8)	300
HM11-22005LF	10 X 25	20 (0.81)	16.20	30.6	22	5.0	5.5	1.06 (27)	.55 (14.0)	.49 (12.4)	1000
HM11-31001LF	8 X 25	10 (2.59)	1.20	1.2	72	28.0	31.0	1.06 (27)	.65 (16.5)	.55 (14.0)	300
HM11-31302LF	8 X 25	13 (1.83)	2.70	2.7	45	14.5	17.0	1.06 (27)	.55 (14.0)	.49 (12.5)	400
HM11-31503LF	8 X 25	15 (1.45)	4.20	4.9	35	11.5	13.5	1.06 (27)	.55 (14.0)	.46 (11.7)	1000
HM11-31804LF	8 X 25	18 (1.02)	7.20	11.6	26	8.0	9.0	1.06 (27)	.50 (12.7)	.43 (10.8)	1000
HM11-32005LF	8 X 25	20 (0.81)	12.00	22.8	22	5.5	6.5	1.06 (27)	.45 (11.4)	.41 (10.4)	1000
HM11-41301LF	6 X 16	13 (1.83)	0.66	1.4	65	13.0	15.0	.71 (18)	.50 (12.7)	.41 (10.5)	660
HM11-41502LF	6 X 16	15 (1.45)	1.00	2.3	50	10.0	12.0	.71 (18)	.45 (11.4)	.38 (9.7)	660
HM11-41803LF	6 X 16	18 (1.02)	2.20	6.1	32	8.0	9.0	.71 (18)	.40 (10.2)	.35 (8.8)	660
HM11-42004LF	6 X 16	20 (.81)	3.30	10.87	23	7.5	8.5	.71 (18)	.40 (10.2)	.33 (8.4)	1,210
HM11-51301LF	5 X 25	13 (1.83)	2.00	1.9	25	17.0	19.5	1.06 (27)	.45 (11.4)	.37 (9.5)	1000
HM11-51502LF	5 X 25	15 (1.45)	2.60	3.2	20	14.5	16.5	1.06 (27)	.45 (11.4)	.34 (8.7)	1000
HM11-51803LF	5 X 25	18 (1.02)	5.50	8.4	14	9.0	10.0	1.06 (27)	.35 (8.9)	.31 (7.8)	1000
HM11-52004LF	5 X 25	20 (0.81)	8.80	16.5	10	6.5	7.0	1.06 (27)	.35 (8.9)	.29 (7.4)	1000
HM11-61301LF	4 X 16	13 (1.83)	0.37	0.9	53	18.0	20.0	.71 (18)	.40 (10.2)	.33 (8.5)	1,210
HM11-61502LF	4 X 16	15 (1.45)	0.68	1.7	38	15.5	17.5	.71 (18)	.40 (10.2)	.30 (7.7)	1,210
HM11-61803LF	4 X 16	18 (1.02)	1.15	3.7	28	10.5	12.0	.71 (18)	.35 (8.9)	.27 (6.8)	450
HM11-62004LF	4 X 16	20 (0.81)	1.80	6.9	20	8.5	9.5	.71 (18)	.30 (7.6)	.25 (6.4)	450
HM11-71001LF	9 X 9	13.5 (1.72)	0.19 \pm 15%	0.76	-	33.0	37.0	.37 (9.5)	.52 (13.2)	.51 (13)	500

Notes: (1) Nominal bare wire diameter. (2) Electrical specifications at 25°C.

General Note

TT Electronics reserves the right to make changes in product specification without notice or liability. All information is subject to TT Electronics' own data and is considered accurate at time of going to print.