

User's Guide

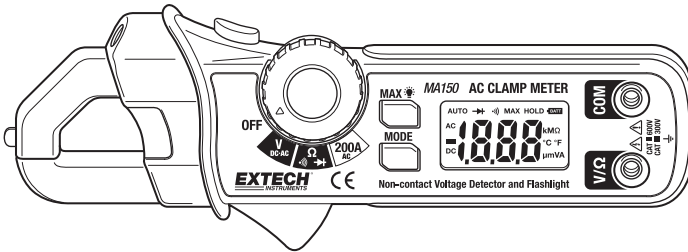

Model MA150 200A AC Mini Clamp-on Meter



- 2000 count LCD display
- White LED backlight
- Built-in non-contact AC voltage detector plus flashlight
- Max Hold
- Autoranging with auto power off
- 0.7" (18mm) Jaw opening

Introduction

Congratulations on your purchase of Extech's MA150 AC Mini Clamp Meter. This meter is shipped fully tested and calibrated and, with proper use, will provide years of reliable service.

Meter Description

- | | |
|---|---------------------------|
| 1. Current sense jaw | 6. LCD display |
| 2. Non-contact AC voltage indicator light | 7. Clamp trigger |
| 3. Flashlight button | 8. MODE key |
| 4. Rotary function switch | 9. COM input jack |
| 5. MAX hold and Backlight key | 10. V Ω input jack |

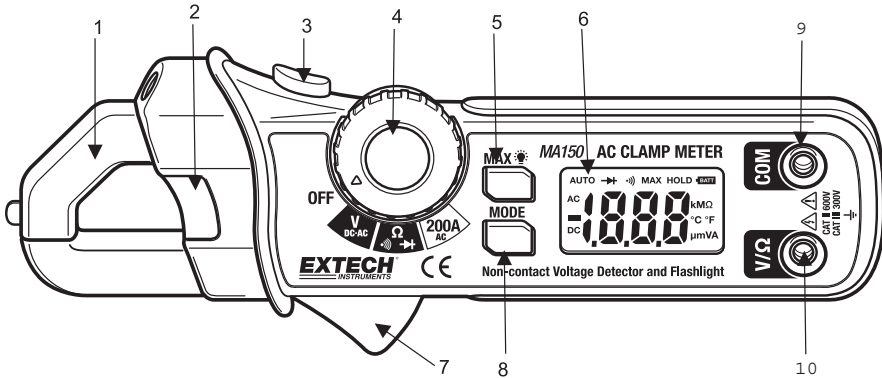

Safety Information

 Caution! Refer to the explanation in this Manual

 Double Insulation

This meter has been designed to be safe in use, but the operator must use caution in its operation. The rules listed below should be carefully followed for safe operation.

- NEVER** apply voltage or current to the meter that exceeds the specified maximum:
- USE EXTREME CAUTION** when working with voltages greater than 60VDC or 25VAC rms. These voltages are considered a shock hazard.
- NEVER** operate the meter unless the back cover and the battery/fuse door are in place and fastened securely.

Input Limits	
Function	Maximum Input
AC Current	200A
AC/DC Voltage	600V AC/DC
Resistance, Diode, Continuity Test	600V AC/DC

Operation

AC Current Measurements



- 1) Set the Function switch to the 200A AC range.
- 2) Press the jaw trigger and clamp around, fully enclosing a single conductor. Do not allow a gap between the two halves of the jaw. Refer to the diagram at right for the correct way to enclose a single conductor.
- 3) Read the ACA value on the LCD.





AC/DC Voltage Measurements

- 1) Insert the black test lead into the negative **COM** terminal and the red test lead into the positive **V** terminal.
- 2) Set the function switch to the **V** position.
- 3) Select AC or DC with the MODE button.
- 4) Connect the test leads in parallel to the circuit under test.
- 5) Read the voltage measurement on the LCD display.

Resistance and Continuity Measurements

- 1) Insert the black test lead into the negative COM terminal and the red test lead into the positive **V** Ω terminal.
- 2) Set the function switch to the Ω  position.
- 3) Use the MODE button to select resistance. The $M\Omega$ icon will appear in the display.
- 4) Touch the test leads across the circuit or component under test. It is best to disconnect one side of the device under test so the rest of the circuit will not interfere with the resistance reading.
- 5) For Resistance tests, read the resistance on the LCD display
- 6) For Continuity, use the MODE button to select continuity ")". The display icons will change when the **MODE** button is pressed.
- 7) If the resistance is $<120 \Omega$  a tone will sound.

Diode Test

- 1) Insert the black test lead banana plug into the negative COM jack and the red test lead banana plug into the positive **V** Ω jack.
- 2) Set the function switch to the Ω  position.
- 3) Press the MODE button to indicate  on the display.
- 4) Touch the test probes to the diode under test. Forward voltage will typically indicate 0.400 to 0.700V. Reverse voltage will indicate "OL". Shorted devices will indicate near 0V and an open device will indicate "OL" in both polarities.

Non-Contact AC Voltage Detection

WARNING: Risk of Electrocution. Before use, always test the Voltage Detector on a known live circuit to verify proper operation

- 1) AC Voltage detection operates on any of the three Function switch positions.
- 2) Touch the probe tip to the hot conductor or insert into the hot side of the electrical outlet.
- 3) If AC voltage is present, the detector light will illuminate.

NOTE: The conductors in electrical cord sets are often twisted. For best results, slowly slide the probe tip along a length of the cord to assure placing the tip in close proximity to the live conductor.

NOTE: The detector is designed with high sensitivity. Static electricity or other sources of energy may randomly turn the detector light on. This is normal operation

MAX Hold

To hold the highest reading on the LCD, momentarily press the “MAX” key. The meter reading will not change as readings change, rather it will only display the highest reading encountered since the MAX hold button was pressed. Press the MAX hold button again to return the meter to normal operation.

Backlight

Press and hold the “MAX” key for more than one second to turn the backlight on. This will also activate the MAX Hold function. To release the MAX Hold function and return the meter to normal operation, press the “MAX” key momentarily. The backlight will automatically turn off after 15 seconds. To manually turn off the backlight, press and hold the “MAX” key for more than 1 second.

Flashlight

Press and hold the top button to turn the flashlight on. Release the button to turn the flashlight off.

Specifications

General Specifications

Display	2000 count Digit LCD with white LED backlight
Polarity	Minus sign (-) indicates negative polarity
Jaw opening	0.7" (18mm)
Current sensor	Hall effect sensor type
AC Current Bandwidth	50/60Hz
AC Voltage Bandwidth	50/400Hz
Overload indication	"OL" displayed on the LCD
Display rate	2 readings/second, nominal
Battery	Two 1.5V AAA batteries
Low Battery indication	"BATT" displayed on the LCD
Auto Power off	approx. 15 minutes
Operating conditions	32 to 86°F (0 to 30°C) 90%RH; 86 to 104°F (30 to 40°C) 75%RH; 104 to 122°F (40 to 50°C) 45%RH
Storage conditions	- 14 to 140°F (-30 to 60°C); < 90% Relative Humidity
Altitude	Operate at less than 3000 meters
Weight	6.2 oz. (176g) including battery
Dimensions	6.5 x 2.6 x 1.3" (164 x 65 x 32mm) (HWD)
Standards	For indoor use and in accordance with the requirements for double insulation to IEC1010-1 (1995): EN61010-1 (1995) Overvoltage Category III 300V and Category II 600V, Pollution Degree 2. 

Range Specifications

Function	Range	Resolution	Accuracy (of reading)
AC Current	200.0A	0.1A	± (2.5% rdg + 10 digits)
DC Voltage	200.0mV	0.1mV	±(0.5% rdg + 5 digits)
	2.000V	1mV	
	20.00V	10mV	
	200.0V	0.1V	±(1.2% rdg + 3 digits)
	600V	1V	
AC Voltage	2.000V	1mV	±(1.5% rdg + 3 digits)
	20.00V	10mV	
	200.0V	0.1V	
	600V	1V	±(2.0% rdg + 4 digits)
Resistance	200.0Ω	0.1Ω	±(1.0% rdg + 4 digits)
	2.000kΩ	1Ω	±(1.5% rdg + 2 digits)
	20.00kΩ	10Ω	
	200.0kΩ	100Ω	
	2.000MΩ	1kΩ	±(2.0% rdg + 3 digits)
	20.00MΩ	10kΩ	±(3.0% rdg + 5 digits)
	Non-Contact AC Voltage	100VAC to 600VAC 50/60Hz	
Diode Test	Test current: 0.3mA typical; Open circuit voltage: 1.5VDC typical		
Continuity	Threshold <120Ω  Test current <1mA		

Maintenance

Battery Replacement

- 1) When the low battery symbol appears on the LCD the batteries must be replaced.
- 2) Power down and remove the rear battery compartment Phillips screw.
- 3) Lift off the battery compartment cover and replace the two 1.5V AAA cells.
- 4) Replace compartment cover and secure the screw.

Cleaning

Caution: Use only a dry cloth to clean the plastic case.

Calibration and Repair Services

Extech offers repair and calibration services for the products we sell. Extech also provides NIST certification for most products. Call the Customer Service Department for information on calibration services available for this product. Extech recommends that annual calibrations be performed to verify meter performance and accuracy.

Warranty

EXTECH INSTRUMENTS CORPORATION warrants this instrument to be free of defects in parts and workmanship for **one year** from date of shipment (a six month limited warranty applies to sensors and cables). If it should become necessary to return the instrument for service during or beyond the warranty period, contact the Customer Service Department at (781) 890-7440 ext. 210 for authorization or visit our website www.extech.com for contact information. A Return Authorization (RA) number must be issued before any product is returned to Extech. The sender is responsible for shipping charges, freight, insurance and proper packaging to prevent damage in transit. This warranty does not apply to defects resulting from action of the user such as misuse, improper wiring, operation outside of specification, improper maintenance or repair, or unauthorized modification. Extech specifically disclaims any implied warranties or merchantability or fitness for a specific purpose and will not be liable for any direct, indirect, incidental or consequential damages. Extech's total liability is limited to repair or replacement of the product. The warranty set forth above is inclusive and no other warranty, whether written or oral, is expressed or implied.



Support line (781) 890-7440

Technical support: Extension 200; E-mail: support@extech.com

Repair & Returns: Extension 210; E-mail: repair@extech.com

Product specifications subject to change without notice

For the latest version of this User Guide, Software updates, and other Up-to-the-minute product information, visit our website: www.extech.com
Extech Instruments Corporation, 285 Bear Hill Road, Waltham, MA 02451

**Copyright © 2007 Extech Instruments Corporation.
All rights reserved including the right of reproduction in whole or in part in any form.**