

PLEASE CHECK WWW.MOLEX.COM FOR LATEST PART INFORMATION

Part Number: [0749525901](#)
Status: **Active**
Overview: vhdm_hsd
Description: 2.00mm (.079") Pitch 5-Row VHDM-HSD™ Backplane Header, Polarizing Pin Module, Code Key A, 40 Circuits

Documents:

[Drawing \(PDF\)](#) [RoHS Certificate of Compliance \(PDF\)](#)
[Product Specification PS-74031-999 \(PDF\)](#)

General

Product Family	Backplane Connectors
Series	74952
Application	Backplane
Application Tooling Documents	Tooling Manual
Comments	Position A, PCB Thickness 4.00mm (.157") to 9.00mm (.354")
Component Type	PCB Header
Overview	vhdm_hsd
Product Name	VHDM-HSD™
Style	N/A

Physical

Circuits (Loaded)	N/A
Durability (mating cycles max)	200
First Mate / Last Break	No
Guide to Mating Part	Yes
Keying to Mating Part	Yes
Material - Metal	Stainless Steel
Number of Columns	6
Number of Pairs	Open Pin Field
Number of Rows	0
Orientation	Vertical
PCB Locator	No
PCB Retention	None
PCB Thickness Recommended (in)	0.071 In
PCB Thickness Recommended (mm)	1.80 mm
Packaging Type	Bag
Pitch - Mating Interface (in)	0.000 In
Pitch - Mating Interface (mm)	0.00 mm
Polarized to PCB	Yes
Surface Mount Compatible (SMC)	Yes
Temperature Range - Operating	N/A

Electrical

Current - Maximum per Contact	N/A
Data Rate	5.0 Gbps
Shield Type	N/A
Shielded	No
Voltage - Maximum	N/A

Material Info

Reference - Drawing Numbers

Product Specification	PS-74031-999
Sales Drawing	SD-74952-002

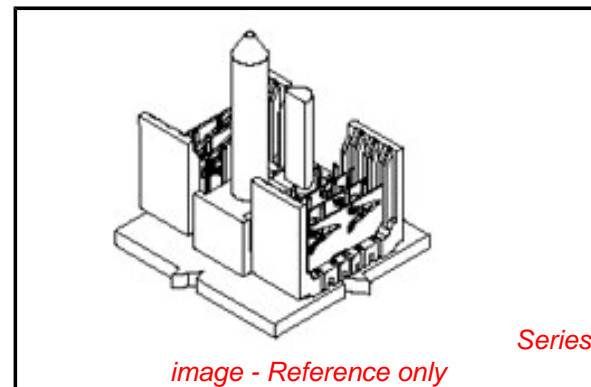

image - Reference only

EU RoHS **China RoHS**

Compliance Status

Not Reviewed

REACH SVHC

Not Reviewed

Halogen-Free

Status

Not Reviewed

Need more information on product environmental compliance?

Email productcompliance@molex.com
 For a multiple part number RoHS Certificate of Compliance, [click here](#)

Please visit the [Contact Us](#) section for any non-product compliance questions.

Search Parts in this Series









[74952Series](#)

| VHDM-HSD is a trademark of Amphenol Corporation

This document was generated on 05/28/2010

PLEASE CHECK WWW.MOLEX.COM FOR LATEST PART INFORMATION

20 19 18 17 16 15 14 13 12 11 10 9 8 7 6 5 4 3 2 1

MATERIAL NUMBER PCB THICKNESS >4.0 - 9.0	MATERIAL NUMBER PCB THICKNESS 18 - 4.0	BUSHING CLOCK POSITION
74952-5901	74952-5001	A 
74952-5902	74952-5002	B 
74952-5903	74952-5003	C 
74952-5904	74952-5004	D 
74952-5905	74952-5005	E 
74952-5906	74952-5006	F 
74952-5907	74952-5007	G 
74952-5908	74952-5008	H 

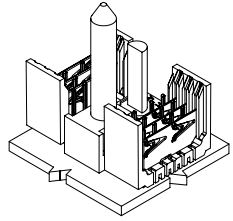
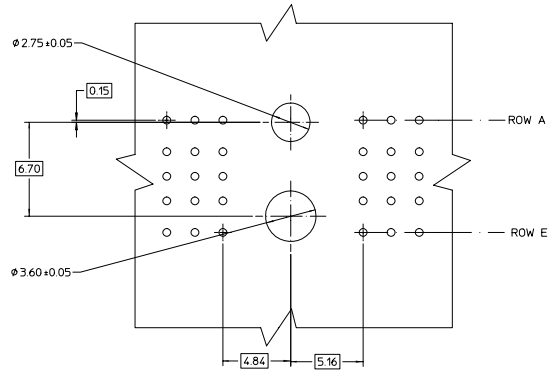
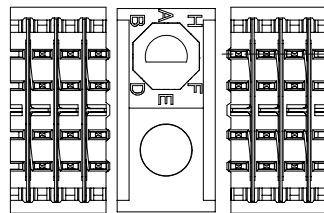

BILL OF MATERIAL FOR 74952-50**

ITEM	DESCRIPTION	QTY.
1	GUIDE PIN	1
2	GUIDANCE & POLARIZING MODULE	1
3	KEYING PIN	1
4	SCREW & WASHER (PCB 18-4.0)	1

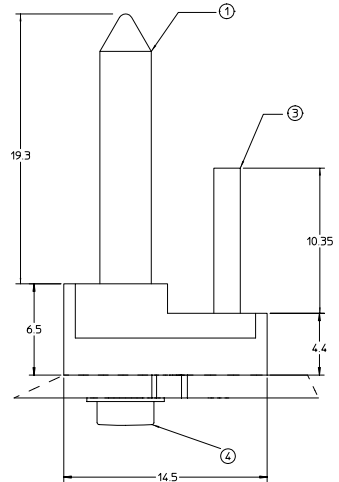
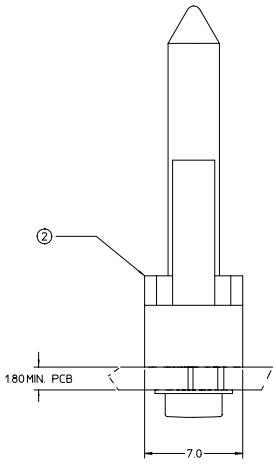

BILL OF MATERIAL FOR 74952-59**

ITEM	DESCRIPTION	QTY.
1	GUIDE PIN	1
2	GUIDANCE & POLARIZING MODULE	1
3	KEYING PIN	1
4	SCREW & WASHER (PCB >4.0-9.0)	1

- NOTES:**
- MATERIAL:
HOUSING: LIQUID CRYSTAL POLYMER (LCP),
COLOR: BLACK
GUIDE PIN / KEYING PIN: STAINLESS STEEL
 - THIS PART CONFORMS TO MOLEX PRODUCT SPECIFICATION PS-74031-999.
 - PACKAGING: STANDARD BULK PACK, 100 PER BAG PACKAGE SCREW SEPARATELY.

EC NO. UDT2002-0216 DRWN: LMSLEY 2001/12/19 CHKD: SREED 2001/12/19 APPR: CBXLER 2001/12/20	QUALITY SYMBOLS ▽-0 ▽-0	GENERAL TOLERANCES (UNLESS SPECIFIED)		SCALE 6:1	DESIGN UNITS METRIC	THIRD ANGLE PROJECTION	REVISE ON CAD ONLY	
		4 PLACES ± --- ± --- 3 PLACES ± --- ± --- 2 PLACES ± --- ± --- 1 PLACE ± --- ± ---	DIMENSION STYLE MM ONLY	DRAWN BY NMARTIN DATE 01/12/11	TITLE BACKPLANE GUIDANCE AND POLARIZING MODULE 5 ROW HSD SALES DRAWING			
		ANGULAR ± 2 °	CHECKED BY SREED DATE 01/12/11	MOLEX MOLEX INCORPORATED				
		DRAFT WHERE APPLICABLE MUST REMAIN WITHIN DIMENSIONS	APPROVED BY CBXLER DATE 01/12/11	MATERIAL NO. SEE CHART	DOCUMENT NO. SD-74952-002	SHEET NO. 1 OF 1	D	

THIS DRAWING CONTAINS INFORMATION THAT IS PROPRIETARY TO MOLEX INCORPORATED AND SHOULD NOT BE USED WITHOUT WRITTEN PERMISSION

1b_frame_D rev B 2000/06/12 19 18 17 16 15 14 13 12 11 10 9 8 7 6 5 4 3 2 1