

Data sheet | Item number: 2002-3217

Triple-deck terminal block; Ground conductor/through/through terminal block; 2.5 mm²; PE/N/L; suitable for Ex e II applications; without marker carrier; for DIN-rail 35 x 15 and 35 x 7.5; Push-in CAGE CLAMP®; 2,50 mm²; gray

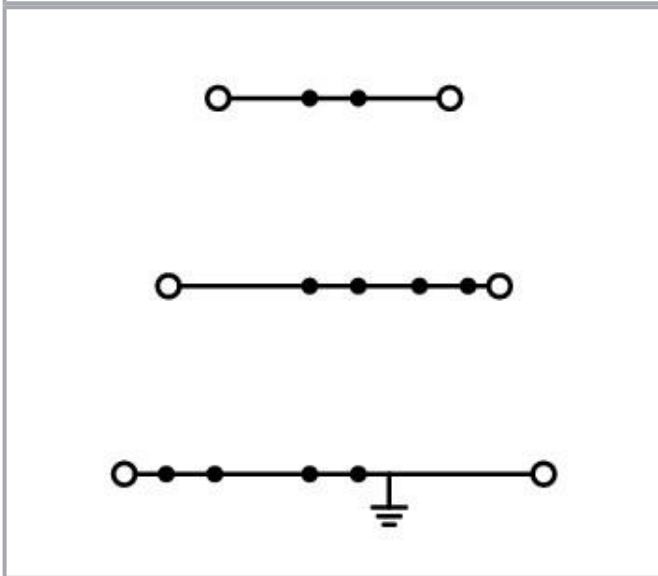

www.wago.com/2002-3217

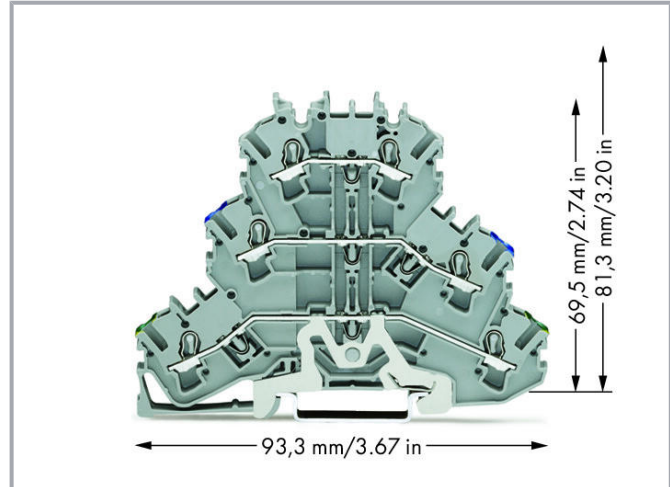
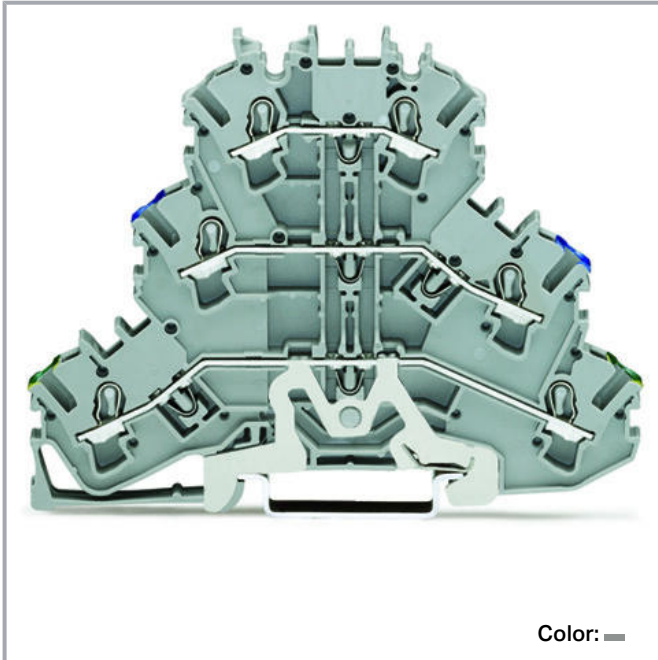

Data

Electrical data

Subject to changes. Please also observe the further product documentation!

WAGO GmbH & Co. KG
Hansastr. 27
32423 Minden
Phone: +49571 887-0 | Fax: +49571 887-169
Email: info.de@wago.com | Web: www.wago.com

Do you have any questions about our products?
We are always happy to take your call at +49 (571) 887-44222.



Ratings per IEC/EN

Ratings per	IEC/EN 60947-7-1
Nominal voltage (III/3)	500 V
Rated surge voltage (III/3)	6 kV
Rated current	24 A
Rated current 2	28 A
Legend (ratings)	(III / 3) ≙ Overvoltage category III / Pollution degree 3

Ratings per UL

Approvals per	UL 1059
Rated voltage UL (Use Group B)	300 V
Rated current UL (Use Group B)	20 A
Rated voltage UL (Use Group C)	300 V
Rated current UL (Use Group C)	20 A
Rated voltage UL (Use Group D)	600 V
Rated current UL (Use Group D)	5 A

Ratings per CSA

Approvals per	C22.2 No 158
Rated voltage CSA (Use Group B)	600 V
Rated current CSA (Use Group B)	20 A
Rated voltage CSA (Use Group C)	600 V
Rated current CSA (Use Group C)	20 A

Ex information

Ratings per	ATEX: PTB 03 ATEX 1162 U / IECEx: PTB 03.0004U (Ex eb IIC Gb)
Rated voltage EN (Ex e II)	440 V
Rated current (Ex e II)	19 A
Rated current (Ex e II) with jumper	17 A

Connection data

Total number of connection points	6
Total number of potentials	3
Number of levels	3
Number of jumper slots	6

Subject to changes. Please also observe the further product documentation!

WAGO GmbH & Co. KG
 Hansastr. 27
 32423 Minden
 Phone: +49571 887-0 | Fax: +49571 887-169
 Email: info.de@wago.com | Web: www.wago.com

Do you have any questions about our products?
 We are always happy to take your call at +49 (571) 887-44222.



Connection 1

Connection technology	Push-in CAGE CLAMP®
Number of connection points	3
Actuation type	Push-in Operating tool
Connectable conductor materials	Copper
Nominal cross-section	2.5 mm ²
Solid conductor	0.25 ... 4 mm ² / 22 ... 12 AWG
Solid conductor; push-in termination	0.75 ... 4 mm ² / 18 ... 12 AWG
Fine-stranded conductor	0.25 ... 4 mm ² / 22 ... 12 AWG
Fine-stranded conductor; with insulated ferrule	0.25 ... 2.5 mm ² / 22 ... 14 AWG
Fine-stranded conductor; with ferrule; push-in termination	1 ... 2.5 mm ² / 18 ... 14 AWG
Note (conductor cross-section)	Depending on the conductor characteristic, a conductor with a smaller cross-section can also be inserted via push-in termination.
Strip length	10 ... 12 mm / 0.39 ... 0.47 inch
Wiring direction	Front-entry wiring

Connection 2

Number of connection points 2	3
-------------------------------	---

Physical data

Width	5.2 mm / 0.205 inch
Height	93.3 mm / 3.673 inch
Depth from upper edge of DIN-rail	69.5 mm / 2.736 inch

Mechanical data

Potentialkennzeichnung	PE/N/L
Design	horizontal type
Mounting type	DIN-35 rail
Marking level	Center/side marking

Material data

Color	gray
Insulation material	Polyamide (PA66)
Flammability class per UL94	V0
Fire load	0.334 MJ

Subject to changes. Please also observe the further product documentation!





Weight	19.7 g
--------	--------

Commercial data

Product Group	22 (TOPJOB S)
PU (SPU)	50 Stück
Packaging type	box
Country of origin	DE
GTIN	4044918691208
Customs tariff number	85369010000

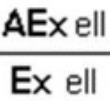
Approvals / Certificates

Ex-Approvals

Logo	Approval	Additional Approval Text	Certificate name
	AEx Underwriters Laboratories Inc.	UL 60079	E185892 (AEx eb IIC resp. Ex eb IIC)
	ATEX Physikalisch Technische Bundesanstalt (PTB)	EN 60079	PTB 03 ATEX 1162 U (II 2 G Ex eb IIC Gb bzw. I M 2 Ex eb I Mb)
	CCCEX CQST/CNEx	CNCA-C23-01	2020312313000238
	EAC Brjansker Zertifizierungsstelle	TP TC 012/2011	RU C-DE.AM02.B. 00127/19 (Ex e IIC Gb U)
	IECEX Physikalisch Technische Bundesanstalt	IEC 60079	IECEX PTB 03.0004 U (Ex eb IIC Gb or Ex eb I Mb)

Country specific Approvals

Logo	Approval	Additional Approval Text	Certificate name
	CCA DEKRA Certification B.V.	EN 60947	71- 107687

Subject to changes. Please also observe the further product documentation!



CCA
DEKRA Certification B.V.

EN 60947

NTR NL
7730





CCA
DEKRA Certification B.V.

C22.2 No. 158

1536069

Ship Approvals

Logo	Approval	Additional Approval Text	Certificate name
	ABS American Bureau of Shipping	EN 60947	20- HG1941090- PDA
	BV Bureau Veritas S.A.	EN 60947	38586/A0 BV
	DNV GL Det Norske Veritas, Germanischer Lloyd	-	TAE00001V2

UL-Approvals

Logo	Approval	Additional Approval Text	Certificate name
	UL Underwriters Laboratories Inc.	UL 1059	E45172

Required accessories

End plate

End plate



Item no.: 2002-3292
End and intermediate plate; 0.8 mm thick; orange

www.wago.com/2002-3292



Item no.: 2002-3291
End and intermediate plate; 0.8 mm thick; gray

www.wago.com/2002-3291





Subject to changes. Please also observe the further product documentation!

WAGO GmbH & Co. KG
Hansastr. 27
32423 Minden
Phone: +49571 887-0 | Fax: +49571 887-169
Email: info.de@wago.com | Web: www.wago.com









Do you have any questions about our products?
We are always happy to take your call at +49 (571) 887-44222.

Optional accessories

Push-in type wire jumper

Jumper		
	Item no.: 2009-412 Push-in type wire jumper; insulated; 60 mm long; black	www.wago.com/2009-412
	Item no.: 2009-414 Push-in type wire jumper; 1.5 mm ² ; insulated; 110 mm long; black	www.wago.com/2009-414
	Item no.: 2009-416 Push-in type wire jumper; 1.5 mm ² ; insulated; 250 mm long; black	www.wago.com/2009-416
	Item no.: 2009-414/000-005 Push-in type wire jumper; 1.5 mm ² ; insulated; 110 mm long; black	www.wago.com/2009-414/000-005
	Item no.: 2009-414/000-006 Push-in type wire jumper; insulated; 110 mm long; black	www.wago.com/2009-414/000-006

Ferrule

Ferrule		
	Item no.: 216-241 Ferrule; Sleeve for 0.5 mm ² / 20 AWG; insulated; electro-tin plated; electrolytic copper; gastight crimped; acc. to DIN 46228, Part 4/09.90; white	www.wago.com/216-241
	Item no.: 216-242 Ferrule; Sleeve for 0.75 mm ² / 18 AWG; insulated; electro-tin plated; electrolytic copper; gastight crimped; acc. to DIN 46228, Part 4/09.90; gray	www.wago.com/216-242
	Item no.: 216-243 Ferrule; Sleeve for 1 mm ² / AWG 18; insulated; electro-tin plated; electrolytic copper; gastight crimped; acc. to DIN 46228, Part 4/09.90; red	www.wago.com/216-243
	Item no.: 216-244 Ferrule; Sleeve for 1.5 mm ² / AWG 16; insulated; electro-tin plated; electrolytic copper; gastight crimped; acc. to DIN 46228, Part 4/09.90; black	www.wago.com/216-244
	Item no.: 216-263 Ferrule; Sleeve for 1 mm ² / AWG 18; insulated; electro-tin plated; electrolytic copper; gastight crimped; acc. to DIN 46228, Part 4/09.90; red	www.wago.com/216-263
	Item no.: 216-246 Ferrule; Sleeve for 2.5 mm ² / AWG 14; insulated; electro-tin plated; electrolytic copper; gastight crimped; acc. to DIN 46228, Part 4/09.90; blue	www.wago.com/216-246
	Item no.: 216-266 Ferrule; Sleeve for 2.5 mm ² / AWG 14; insulated; electro-tin plated; electrolytic copper; gastight crimped; acc. to DIN 46228, Part 4/09.90; blue	www.wago.com/216-266
	Item no.: 216-264 Ferrule; Sleeve for 1.5 mm ² / AWG 16; insulated; electro-tin plated; electrolytic copper; gastight crimped; acc. to DIN 46228, Part 4/09.90; black	www.wago.com/216-264
	Item no.: 216-262 Ferrule; Sleeve for 0.75 mm ² / 18 AWG; insulated; electro-tin plated; electrolytic copper; gastight crimped; acc. to DIN 46228, Part 4/09.90; gray	www.wago.com/216-262

Subject to changes. Please also observe the further product documentation!

Mounting

Mounting accessories



Item no.: 709-156

Cover; Type 3; suitable for cover carrier, type 3; 1 m long; transparent

www.wago.com/709-156



Item no.: 709-169

Cover carrier; Type 3; gray

www.wago.com/709-169

Protective warning marker

Cover

Item no.: 2002-115

Protective warning marker; with high-voltage symbol, black; for 5 terminal blocks; yellow

www.wago.com/2002-115

Testing and measuring

Testing accessories



Item no.: 2009-174

Test plug adapter; for 4 mm Ø test plugs; for testing TOPJOB®S rail-mounted terminal blocks; gray

www.wago.com/2009-174



Item no.: 2009-182

Testing tap; for max. 2.5 mm²; tool-free connection for individual test wires 0.08 - 2.5 mm; gray

www.wago.com/2009-182



Item no.: 2002-611

TOPJOB®S L-type test plug module; modular; 1-pole; 2,50 mm²; gray

www.wago.com/2002-611



Item no.: 2002-649

TOPJOB®S L-type spacer module; modular; e.g., for bridging commoned terminal blocks; gray

www.wago.com/2002-649

Carrier rail

Mounting accessories



Item no.: 210-197

Steel carrier rail; 35 x 15 mm; 1.5 mm thick; 2 m long; slotted; similar to EN 60715; silver-colored

www.wago.com/210-197



Item no.: 210-198

Copper carrier rail; 35 x 15 mm; 2.3 mm thick; 2 m long; unslotted; according to EN 60715; copper-colored

www.wago.com/210-198



Item no.: 210-504

Steel carrier rail; 35 x 7.5 mm; 1 mm thick; 2 m long; slotted; galvanized; according to EN 60715; silver-colored

www.wago.com/210-504

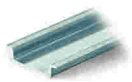

Item no.: 210-505

Steel carrier rail; 35 x 7.5 mm; 1 mm thick; 2 m long; unslotted; galvanized; according to EN 60715; silver-colored

www.wago.com/210-505



Item no.: 210-506

Steel carrier rail; 35 x 15 mm; 1.5 mm thick; 2 m long; unslotted; galvanized; similar to EN 60715; silver-colored

www.wago.com/210-506

Item no.: 210-508

Subject to changes. Please also observe the further product documentation!

WAGO GmbH & Co. KG

Hansastr. 27











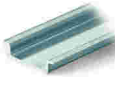

32423 Minden

Phone: +49571 887-0 | Fax: +49571 887-169





Email: info.de@wago.com | Web: www.wago.com

Do you have any questions about our products?

We are always happy to take your call at +49 (571) 887-44222.

	Steel carrier rail; 35 x 15 mm; 1.5 mm thick; 2 m long; slotted; galvanized; similar to EN 60715; silver-colored	www.wago.com/210-508
	Item no.: 210-113 Steel carrier rail; 35 x 7.5 mm; 1 mm thick; 2 m long; unslotted; according to EN 60715; silver-colored	www.wago.com/210-113
	Item no.: 210-118 Steel carrier rail; 35 x 15 mm; 2.3 mm thick; 2 m long; unslotted; according to EN 60715; silver-colored	www.wago.com/210-118
	Item no.: 210-112 Steel carrier rail; 35 x 7.5 mm; 1 mm thick; 2 m long; slotted; according to EN 60715; "Hole width 25 mm; silver-colored	www.wago.com/210-112
	Item no.: 210-114 Steel carrier rail; 35 x 15 mm; 1.5 mm thick; 2 m long; unslotted; similar to EN 60715; silver-colored	www.wago.com/210-114
	Item no.: 210-115 Steel carrier rail; 35 x 7.5 mm; 1 mm thick; 2 m long; slotted; according to EN 60715; "Hole width 18 mm; silver-colored	www.wago.com/210-115
	Item no.: 210-196 Aluminum carrier rail; 35 x 8.2 mm; 1.6 mm thick; 2 m long; unslotted; similar to EN 60715; silver-colored	www.wago.com/210-196
Marking accessories		
Marking strip		
	Item no.: 2009-110 Marking strips; for Smart Printer; on reel; not stretchable; plain; snap-on type; white	www.wago.com/2009-110
Marker carrier		
	Item no.: 2009-198 Adaptor; gray	www.wago.com/2009-198
	Item no.: 2002-131 Adaptor; gray	www.wago.com/2002-131
	Item no.: 2002-161 Adaptor; gray	www.wago.com/2002-161
Marker		
	Item no.: 2009-115/000-002 WMB-Inline; for Smart Printer; 1500 pieces on roll; stretchable 5 - 5.2 mm; plain; snap-on type; yellow	www.wago.com/2009-115/000-002
	Item no.: 2009-115/000-007 WMB-Inline; for Smart Printer; 1500 pieces on roll; stretchable 5 - 5.2 mm; plain; snap-on type; gray	www.wago.com/2009-115/000-007
Item no.: 2009-115/000-017		

Subject to changes. Please also observe the further product documentation!

	WMB-Inline; for Smart Printer; 1500 pieces on roll; stretchable 5 - 5.2 mm; plain; snap-on type; light green	www.wago.com/2009-115/000-017
	Item no.: 2009-115/000-023 WMB-Inline; for Smart Printer; 1500 pieces on roll; stretchable 5 - 5.2 mm; plain; snap-on type; green	www.wago.com/2009-115/000-023
	Item no.: 2009-115/000-024 WMB-Inline; for Smart Printer; 1500 pieces on roll; stretchable 5 - 5.2 mm; plain; snap-on type; violet	www.wago.com/2009-115/000-024
	Item no.: 2009-145/000-006 Mini-WSB Inline; for Smart Printer; 1700 pieces on roll; stretchable 5 - 5.2 mm; plain; snap-on type; blue	www.wago.com/2009-145/000-006
	Item no.: 2009-145 Mini-WSB Inline; for Smart Printer; 1700 pieces on roll; stretchable 5 - 5.2 mm; plain; snap-on type; white	www.wago.com/2009-145
	Item no.: 2009-145/000-002 Mini-WSB Inline; for Smart Printer; 1700 pieces on roll; stretchable 5 - 5.2 mm; plain; snap-on type; yellow	www.wago.com/2009-145/000-002
	Item no.: 2009-145/000-007 Mini-WSB Inline; for Smart Printer; 1700 pieces on roll; stretchable 5 - 5.2 mm; plain; snap-on type; gray	www.wago.com/2009-145/000-007
	Item no.: 2009-145/000-005 Mini-WSB Inline; for Smart Printer; 1700 pieces on roll; stretchable 5 - 5.2 mm; plain; snap-on type; red	www.wago.com/2009-145/000-005
	Item no.: 2009-145/000-012 Mini-WSB Inline; for Smart Printer; 1700 pieces on roll; stretchable 5 - 5.2 mm; plain; snap-on type; orange	www.wago.com/2009-145/000-012
	Item no.: 2009-145/000-023 Mini-WSB Inline; for Smart Printer; 1700 pieces on roll; stretchable 5 - 5.2 mm; plain; snap-on type; green	www.wago.com/2009-145/000-023
	Item no.: 2009-145/000-024 Mini-WSB Inline; for Smart Printer; 1700 pieces on roll; stretchable 5 - 5.2 mm; plain; snap-on type; violet	www.wago.com/2009-145/000-024
	Item no.: 2009-115 WMB-Inline; for Smart Printer; 1500 pieces on roll; stretchable 5 - 5.2 mm; plain; snap-on type; white	www.wago.com/2009-115
	Item no.: 248-501/000-006 Mini-WSB marking card; as card; not stretchable; plain; snap-on type; blue	www.wago.com/248-501/000-006

Subject to changes. Please also observe the further product documentation!



Item no.: 248-501/000-007
Mini-WSB marking card; as card; not stretchable; plain; snap-on type; gray

www.wago.com/248-501/000-007



Item no.: 248-501/000-002
Mini-WSB marking card; as card; not stretchable; plain; snap-on type; yellow

www.wago.com/248-501/000-002



Item no.: 248-501/000-012
Mini-WSB marking card; as card; not stretchable; plain; snap-on type; orange

www.wago.com/248-501/000-012



Item no.: 248-501
Mini-WSB marking card; as card; not stretchable; plain; snap-on type; white

www.wago.com/248-501



Item no.: 248-501/000-017
Mini-WSB marking card; as card; not stretchable; plain; snap-on type; light green

www.wago.com/248-501/000-017



Item no.: 248-501/000-005
Mini-WSB marking card; as card; not stretchable; plain; snap-on type; red

www.wago.com/248-501/000-005



Item no.: 248-501/000-024
Mini-WSB marking card; as card; not stretchable; plain; snap-on type; violet

www.wago.com/248-501/000-024



Item no.: 248-501/000-023
Mini-WSB marking card; as card; not stretchable; plain; snap-on type; green

www.wago.com/248-501/000-023

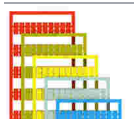

Item no.: 793-5501/000-007
WMB marking card; as card; for terminal block width 5 - 17.5 mm; stretchable 5 - 5.2 mm; plain; snap-on type; gray

www.wago.com/793-5501/000-007



Item no.: 793-5501/000-012
WMB marking card; as card; for terminal block width 5 - 17.5 mm; stretchable 5 - 5.2 mm; plain; snap-on type; orange

www.wago.com/793-5501/000-012



Item no.: 793-5501/000-014
WMB marking card; as card; for terminal block width 5 - 17.5 mm; stretchable 5 - 5.2 mm; plain; snap-on type; brown

www.wago.com/793-5501/000-014

Item no.: 793-5501/000-017

Subject to changes. Please also observe the further product documentation!



WMB marking card; as card; for terminal block width 5 - 17.5 mm; stretchable 5 - 5.2 mm; plain; snap-on type; green www.wago.com/793-5501/000-017



Item no.: 793-5501/000-023
WMB marking card; as card; for terminal block width 5 - 17.5 mm; stretchable 5 - 5.2 mm; plain; snap-on type; light green www.wago.com/793-5501/000-023



Item no.: 793-5501/000-024
WMB marking card; as card; for terminal block width 5 - 17.5 mm; stretchable 5 - 5.2 mm; plain; snap-on type; violet www.wago.com/793-5501/000-024



Item no.: 793-501/000-002
WMB marking card; as card; not stretchable; plain; snap-on type; yellow www.wago.com/793-501/000-002



Item no.: 793-501/000-007
WMB marking card; as card; not stretchable; plain; snap-on type; gray www.wago.com/793-501/000-007



Item no.: 793-501/000-017
WMB marking card; as card; not stretchable; plain; snap-on type; light green www.wago.com/793-501/000-017



Item no.: 793-501/000-012
WMB marking card; as card; not stretchable; plain; snap-on type; orange www.wago.com/793-501/000-012



Item no.: 793-501/000-023
WMB marking card; as card; not stretchable; plain; snap-on type; green www.wago.com/793-501/000-023

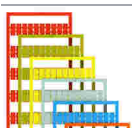

Item no.: 793-501/000-006
WMB marking card; as card; not stretchable; plain; snap-on type; blue www.wago.com/793-501/000-006

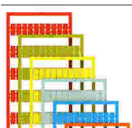

Item no.: 793-501/000-005
WMB marking card; as card; not stretchable; plain; snap-on type; red www.wago.com/793-501/000-005



Item no.: 793-501
WMB marking card; as card; not stretchable; plain; snap-on type; white www.wago.com/793-501

Subject to changes. Please also observe the further product documentation!



Item no.: 793-501/000-024
WMB marking card; as card; not stretchable; plain; snap-on type; violet

www.wago.com/793-501/000-024



Item no.: 793-5501/000-005
WMB marking card; as card; for terminal block width 5 - 17.5 mm; stretchable 5 - 5.2 mm; plain; snap-on type; red

www.wago.com/793-5501/000-005



Item no.: 793-5501/000-002
WMB marking card; as card; for terminal block width 5 - 17.5 mm; stretchable 5 - 5.2 mm; plain; snap-on type; yellow

www.wago.com/793-5501/000-002



Item no.: 793-5501/000-006
WMB marking card; as card; for terminal block width 5 - 17.5 mm; stretchable 5 - 5.2 mm; plain; snap-on type; blue

www.wago.com/793-5501/000-006



Item no.: 793-5501
WMB marking card; as card; for terminal block width 5 - 17.5 mm; stretchable 5 - 5.2 mm; plain; snap-on type; white

www.wago.com/793-5501



Item no.: 2009-115/000-012
WMB-Inline; for Smart Printer; 1500 pieces on roll; stretchable 5 - 5.2 mm; plain; snap-on type; orange

www.wago.com/2009-115/000-012



Item no.: 2009-115/000-006
WMB-Inline; for Smart Printer; 1500 pieces on roll; stretchable 5 - 5.2 mm; plain; snap-on type; blue

www.wago.com/2009-115/000-006



Item no.: 2009-115/000-005
WMB-Inline; for Smart Printer; 1500 pieces on roll; stretchable 5 - 5.2 mm; plain; snap-on type; red

www.wago.com/2009-115/000-005

Group marker carrier



Item no.: 2009-193
Group marker carrier

www.wago.com/2009-193



Item no.: 2009-192
Group marker carrier

www.wago.com/2009-192



Item no.: 2009-191
Group marker carrier

www.wago.com/2009-191

Jumpers

Jumper

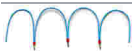

Item no.: 210-123
Wire commoning chain; insulated; blue













www.wago.com/210-123



Item no.: 2002-402
Jumper; 2-way; insulated; light gray

www.wago.com/2002-402

Subject to changes. Please also observe the further product documentation!

	Item no.: 2002-402/000-005 Jumper; 2-way; insulated; red	www.wago.com/2002-402/000-005
	Item no.: 2002-400 Continuous jumper; 2-way; insulated; light gray	www.wago.com/2002-400
	Item no.: 2002-403 Jumper; 3-way; insulated; light gray	www.wago.com/2002-403
	Item no.: 2002-404/000-005 Jumper; 4-way; insulated; red	www.wago.com/2002-404/000-005
	Item no.: 2002-403/000-006 Jumper; 3-way; insulated; blue	www.wago.com/2002-403/000-006
	Item no.: 2002-404/000-006 Jumper; 4-way; insulated; blue	www.wago.com/2002-404/000-006
	Item no.: 2002-403/000-005 Jumper; 3-way; insulated; red	www.wago.com/2002-403/000-005
	Item no.: 2002-405/000-005 Jumper; 5-way; insulated; red	www.wago.com/2002-405/000-005
	Item no.: 2002-402/000-006 Jumper; 2-way; insulated; blue	www.wago.com/2002-402/000-006
	Item no.: 2002-405/000-006 Jumper; 5-way; insulated; blue	www.wago.com/2002-405/000-006
	Item no.: 2002-404 Jumper; 4-way; insulated; light gray	www.wago.com/2002-404
	Item no.: 2002-406/000-006 Jumper; 6-way; insulated; blue	www.wago.com/2002-406/000-006
	Item no.: 2002-406/000-005 Jumper; 6-way; insulated; red	www.wago.com/2002-406/000-005

Subject to changes. Please also observe the further product documentation!



Item no.: 2002-406/020-000
Delta jumper; insulated; light gray

www.wago.com/2002-406/020-000



Item no.: 2002-405
Jumper; 5-way; insulated; light gray

www.wago.com/2002-405



Item no.: 2002-407/000-005
Jumper; 7-way; insulated; red

www.wago.com/2002-407/000-005



Item no.: 2002-408
Jumper; 8-way; insulated; light gray

www.wago.com/2002-408



Item no.: 2002-408/000-006
Jumper; 8-way; insulated; blue

www.wago.com/2002-408/000-006



Item no.: 2002-405/011-000
Star point jumper; 3-way; insulated; light gray

www.wago.com/2002-405/011-000



Item no.: 2002-407/000-006
Jumper; 7-way; insulated; blue

www.wago.com/2002-407/000-006



Item no.: 2002-408/000-005
Jumper; 8-way; insulated; red

www.wago.com/2002-408/000-005



Item no.: 2002-407
Jumper; 7-way; insulated; light gray

www.wago.com/2002-407



Item no.: 2002-406
Jumper; 6-way; insulated; light gray

www.wago.com/2002-406



Item no.: 2002-410/000-005
Jumper; 10-way; insulated; red

www.wago.com/2002-410/000-005



Item no.: 2002-410/000-006
Jumper; 10-way; insulated; blue

www.wago.com/2002-410/000-006



Item no.: 2002-410
Jumper; 10-way; insulated; light gray

www.wago.com/2002-410

Subject to changes. Please also observe the further product documentation!



Item no.: 2002-409/000-006
Jumper; 9-way; insulated; blue

www.wago.com/2002-409/000-006



Item no.: 2002-409/000-005
Jumper; 9-way; insulated; red

www.wago.com/2002-409/000-005



Item no.: 2002-409
Jumper; 9-way; insulated; light gray

www.wago.com/2002-409



Item no.: 2002-423/000-006
Continuous jumper; from 1 to 3; insulated; blue

www.wago.com/2002-423/000-006



Item no.: 2002-423
Continuous jumper; from 1 to 3; insulated; light gray

www.wago.com/2002-423

Item no.: 2002-433
Jumper; from 1 to 3; insulated; light gray

www.wago.com/2002-433

Item no.: 2002-434
Jumper; from 1 to 4; insulated; light gray

www.wago.com/2002-434



Item no.: 2002-423/000-005
Continuous jumper; from 1 to 3; insulated; red

www.wago.com/2002-423/000-005

Item no.: 2002-435
Jumper; from 1 to 5; insulated; light gray

www.wago.com/2002-435

Item no.: 2002-436
Jumper; from 1 to 6; insulated; light gray

www.wago.com/2002-436

Item no.: 2002-437
Jumper; from 1 to 7; insulated; light gray

www.wago.com/2002-437

Item no.: 2002-438
Jumper; from 1 to 8; insulated; light gray

www.wago.com/2002-438

Item no.: 2002-439
Jumper; from 1 to 9; insulated; light gray

www.wago.com/2002-439

Item no.: 2002-440
Jumper; from 1 to 10; insulated; light gray

www.wago.com/2002-440



Item no.: 2002-472
Staggered jumper; 2-way; insulated; light gray

www.wago.com/2002-472



Item no.: 2002-473
Staggered jumper; 3-way; insulated; light gray

www.wago.com/2002-473

Subject to changes. Please also observe the further product documentation!



Item no.: 2002-475/011-000
Staggered jumper; 3-way; insulated; light gray

www.wago.com/2002-475/011-000



Item no.: 2002-475
Staggered jumper; 5-way; insulated; light gray

www.wago.com/2002-475



Item no.: 2002-476
Staggered jumper; 6-way; insulated; light gray

www.wago.com/2002-476



Item no.: 2002-474
Staggered jumper; 4-way; insulated; light gray

www.wago.com/2002-474



Item no.: 2002-477
Staggered jumper; 7-way; insulated; light gray

www.wago.com/2002-477



Item no.: 2002-473/011-000
Staggered jumper; 2-way; from 1 to 3; insulated; light gray

www.wago.com/2002-473/011-000



Item no.: 2002-479
Staggered jumper; 9-way; insulated; light gray

www.wago.com/2002-479



Item no.: 2002-478
Staggered jumper; 8-way; insulated; light gray

www.wago.com/2002-478



Item no.: 2002-479/011-000
Staggered jumper; insulated; light gray

www.wago.com/2002-479/011-000



Item no.: 2002-480
Staggered jumper; 10-way; insulated; light gray

www.wago.com/2002-480



Item no.: 2002-477/011-000
Staggered jumper; insulated; light gray

www.wago.com/2002-477/011-000



Item no.: 2002-492
Vertical jumper; insulated; light gray

www.wago.com/2002-492



Item no.: 2002-481/011-000
Staggered jumper; insulated; light gray

www.wago.com/2002-481/011-000



Item no.: 2002-493
Vertical jumper; insulated; light gray

www.wago.com/2002-493

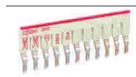

Item no.: 2002-481
Staggered jumper; 11-way; insulated; light gray

www.wago.com/2002-481

Subject to changes. Please also observe the further product documentation!

Item no.: 2002-492/000-012
Vertical jumper; insulated; orange

www.wago.com/2002-492/000-012



Item no.: 2002-482
Staggered jumper; 12-way; insulated; light gray

www.wago.com/2002-482



Item no.: 210-103
Wire commoning chain; insulated; black

www.wago.com/210-103

Insulation stop

Insulation stop

Item no.: 2002-171
Insulation stop; 0.25 - 0.5 mm²; 5 pieces/strip; light gray

www.wago.com/2002-171

Item no.: 2002-172
Insulation stop; 0.75 - 1 mm²; 5 pieces/strip; dark gray

www.wago.com/2002-172

Tool

Operating tool



Item no.: 210-658
Operating tool; Blade: 3.5 x 0.5 mm; with a partially insulated shaft; angled; short; multicoloured

www.wago.com/210-658



Item no.: 210-720
Operating tool; Blade: 3.5 x 0.5 mm; with a partially insulated shaft; multicoloured

www.wago.com/210-720

Downloads

Documentation

Bid Text

2002-3217 docx - Datei	2019. 4. 18.	docx 15.9 kB	Download
2002-3217 X81 - Datei	2019. 4. 18.	xml 4.4 kB	Download

Additional Information

Technical explanations		pdf 2.2 MB	Download
------------------------	--	---------------	----------

CAD/CAE-Data

CAD data

2D/3D Models 2002-3217		URL	Download
------------------------	--	-----	----------

CAE data

Subject to changes. Please also observe the further product documentation!

EPLAN Data Portal 2002-3217	URL	Download
WSCAD Universe 2002-3217	URL	Download
ZUKEN Portal 2002-3217	URL	Download

Environmental Product Compliance

Compliance Search

Environmental Product Compliance 2002-3217	URL	Download
--	---------------------	--------------------------

Triple-deck terminal block; Ground conductor/through/through terminal block; 2.5 mm²; PE/N/L; suitable for Ex e II applications; without marker carrier; for DIN-rail 35 x 15 and 35 x 7.5; Push-in CAGE CLAMP®; 2,50 mm²; gray

Installation Notes

Conductor termination

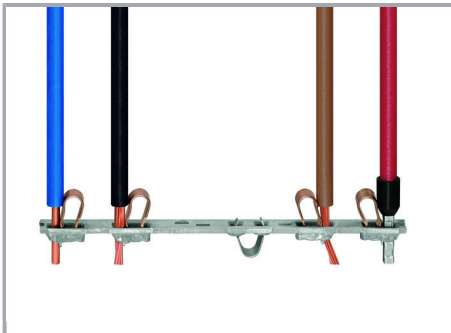

All conductor types at a glance

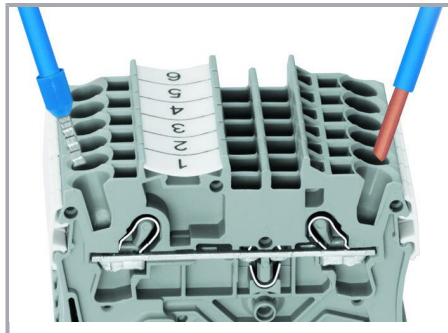

Push-in termination of solid and ferruled conductors

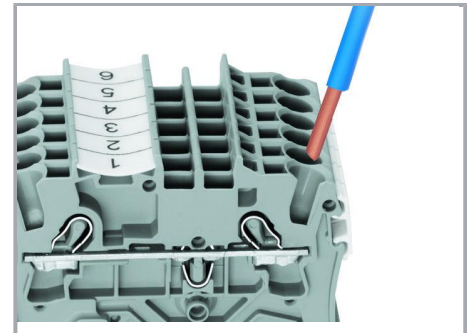

Inserting a conductor via push-in termination:

Solid conductors with cross-sections from either one size above, or up to two sizes below, the rated cross-section can be simply pushed in – no tools needed.

Subject to changes. Please also observe the further product documentation!



Inserting a conductor via operating tool:

Conductor termination – insulation stop

Connecting fine-stranded conductors without ferrules, or small cross-sectional conductors that cannot be pushed in, is performed similarly to the original CAGE CLAMP® – just use an operating tool.

Advantage:

To open the clamp, the operating tool is inserted vertically. The conductor entry is less than 15 degrees for easier wiring.

Commoning

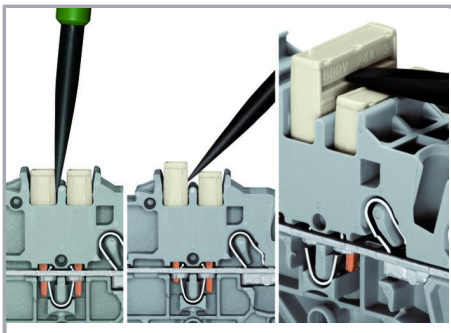

Removing a push-in type jumper bar:

Insert the operating tool between the jumper and partition wall of the dual jumper slots, then lift up the jumper.

Place the operating tool in the center of jumpers for up to five contacts (see above), or alternately on both sides for jumpers with more than five contacts.

Subject to changes. Please also observe the further product documentation!

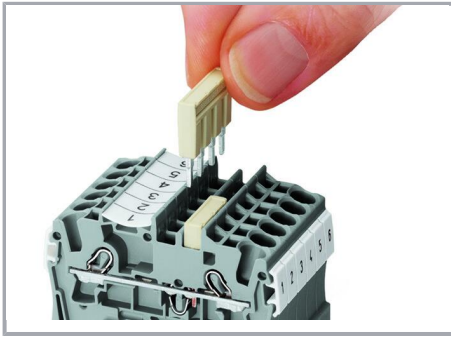

The push-in type jumper bar system is based on the common plug and socket principle. Each terminal block is spring-loaded with a double socket and a resilient CrNi steel spring. The jumper contact material is pure electrolytic copper, which allows for an extremely small design capable of carrying the full-rated current of the terminal block. Ground terminal blocks can also be commoned using the same jumper system. Custom jumpers are created by breaking and removing jumper contacts (2000, 2001, 2002, 2004 Series).

Commoning

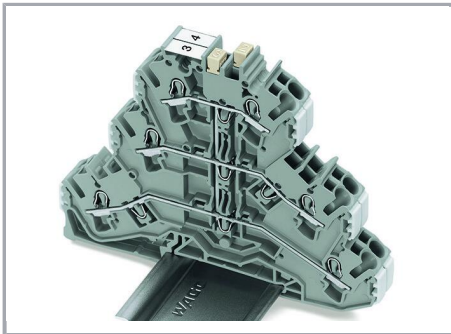

Commoning three levels via triple-deck vertical jumper (2002-493).



Created for double- and triple-deck TOPJOB® S Terminal Blocks, the vertical jumpers can common two or three levels. Clearly marked numerals ("2" and "3") distinguish the double-deck (2002-0492) and triple-deck vertical jumpers (2002-0493), even when inserted.

Product family

Subject to changes. Please also observe the further product documentation!



TOPJOB® S

TOPJOB® S: In various industrial applications and modern building installations, WAGO's wide and versatile range of rail-mount terminal blocks provides more than just reliable electrical connections.

[Show all products from the family](#)

Subject to changes. Please also observe the further product documentation!

WAGO GmbH & Co. KG
Hansastr. 27
32423 Minden
Phone: +49571 887-0 | Fax: +49571 887-169
Email: info.de@wago.com | Web: www.wago.com

Do you have any questions about our products?
We are always happy to take your call at +49 (571) 887-44222.