



LIGITEK

LIGITEK ELECTRONICS CO.,LTD.  
Property of Ligitek Only

---

SINGLE DIGIT LED DISPLAY (0.50 Inch)

## LSD505/61-XX/RP20

# DATA SHEET

DOC. NO : QW0905-LSD505/61-XX/RP20

REV. : A

DATE : 22 - Nov. - 2005



### Package Dimensions

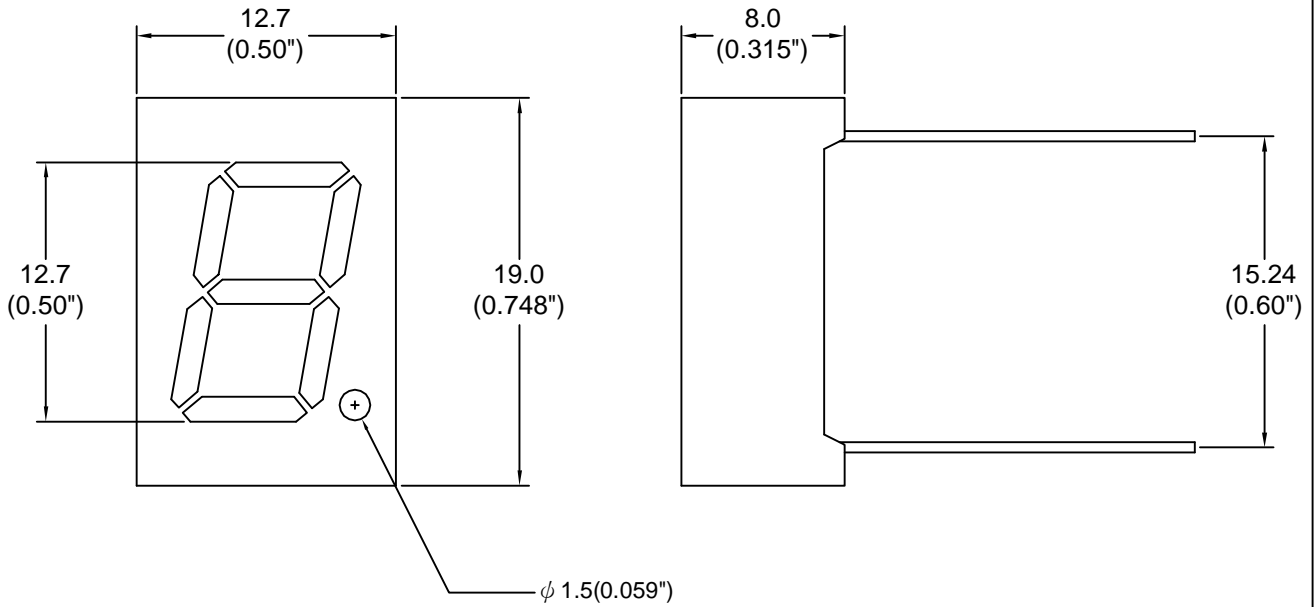

LSD505/61-XX/RP20  
LIGITEK

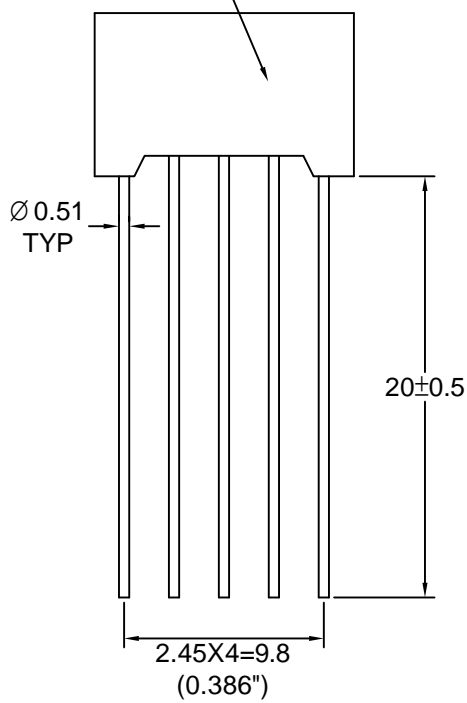

PIN NO.1 →

Note : 1.All dimension are in millimeters and (Inch) tolerance is  $\pm 0.25(0.01")$  unless otherwise noted.  
2.Specifications are subject to change without notice.



Internal Circuit Diagram

LSD5051-XX/RP20

3,8

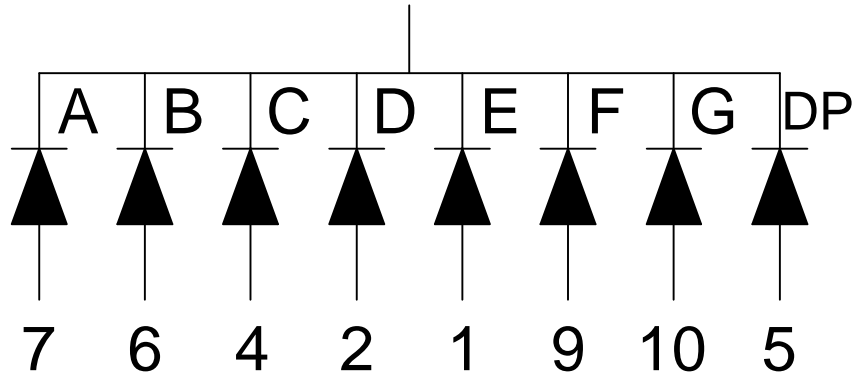

LSD5061-XX/RP20

3,8

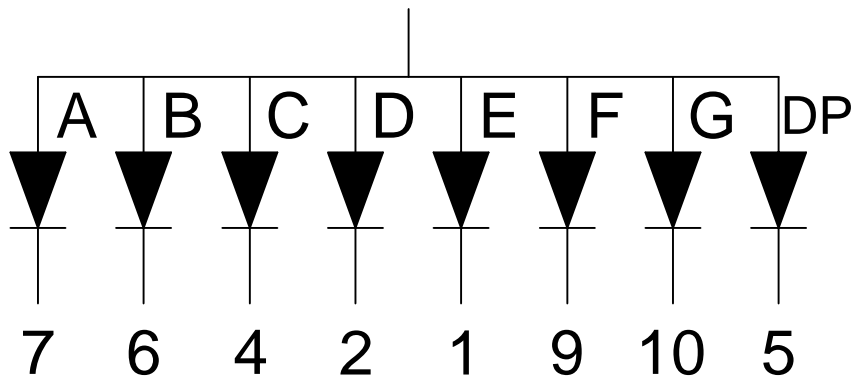



### Electrical Connection

| PIN NO. | LSD5051-XX/RP20 | PIN NO. | LSD5061-XX/RP20 |
|---------|-----------------|---------|-----------------|
| 1       | Anode E         | 1       | Cathode E       |
| 2       | Anode D         | 2       | Cathode D       |
| 3       | Common Cathode  | 3       | Common Anode    |
| 4       | Anode C         | 4       | Cathode C       |
| 5       | Anode DP        | 5       | Cathode DP      |
| 6       | Anode B         | 6       | Cathode B       |
| 7       | Anode A         | 7       | Cathode A       |
| 8       | Common Cathode  | 8       | Common Anode    |
| 9       | Anode F         | 9       | Cathode F       |
| 10      | Anode G         | 10      | Cathode G       |



## Absolute Maximum Ratings at Ta=25 °C

| Parameter  | Symbol | Ratings   | UNIT |
|--|--------|-----------|------|
|  |        | H         |      |
| Forward Current Per Chip   | IF     | 15        | mA   |
| Peak Forward Current Per Chip (Duty 1/10,0.1ms Pulse Width)              | IFP    | 60        | mA   |
| Power Dissipation Per Chip   | PD     | 40        | mW   |
| Reverse Current Per Any Chip   | Ir     | 10        | μA   |
| Operating Temperature  | Topr   | -25 ~ +85 | °C   |
| Storage Temperature  | Tstg   | -25 ~ +85 | °C   |
| Solder Temperature 1/16 Inch Below Seating Plane For 3 Seconds At 260 °C |        |           |      |

## Part Selection And Application Information(Ratings at 25°C)

| PART NO         | CHIP     |         | common cathode or anode | λ P (nm) | Δ λ (nm) | Electrical |      |      |         |      | IV-M |
|-----------------|----------|---------|-------------------------|----------|----------|------------|------|------|---------|------|------|
|                 | Material | Emitted |                         |          |          | Vf(v)      |      |      | Iv(mcd) |      |      |
|                 |          |         |                         |          |          | Min.       | Typ. | Max. | Min.    | Typ. |      |
| LSD5051-XX/RP20 | GaP      | Red     | Common Cathode          | 697      | 90       | 1.7        | 2.1  | 2.6  | 0.35    | 0.5  | 2:1  |
| LSD5061-XX/RP20 |          |         | Common Anode            |          |          |            |      |      |         |      |      |

- Note : 1.The forward voltage data did not including  $\pm 0.1V$  testing tolerance.  
2. The luminous intensity data did not including  $\pm 15\%$  testing tolerance.

**Test Condition For Each Parameter**

| Parameter                         | Symbol           | Unit    | Test Condition       |
|-----------------------------------|------------------|---------|----------------------|
| Forward Voltage Per Chip          | V <sub>f</sub>   | volt    | I <sub>f</sub> =20mA |
| Luminous Intensity Per Chip       | I <sub>v</sub>   | mcd     | I <sub>f</sub> =10mA |
| Peak Wavelength                   | $\lambda P$      | nm      | I <sub>f</sub> =20mA |
| Spectral Line Half-Width          | $\Delta \lambda$ | nm      | I <sub>f</sub> =20mA |
| Reverse Current Any Chip          | I <sub>r</sub>   | $\mu A$ | V <sub>r</sub> =5V   |
| Luminous Intensity Matching Ratio | IV-M             |         |                      |



### Typical Electro-Optical Characteristics Curve

H CHIP

Fig.1 Forward current vs. Forward Voltage

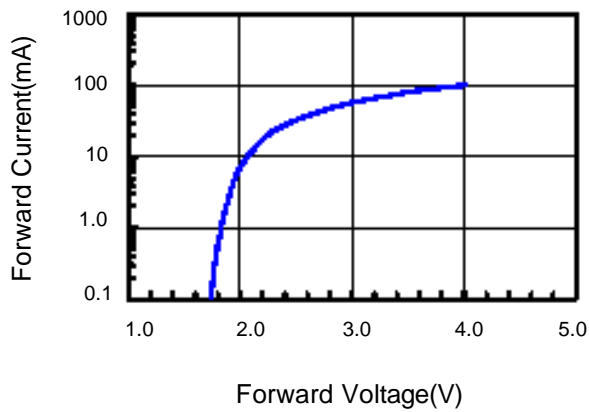

Fig.2 Relative Intensity vs. Forward Current

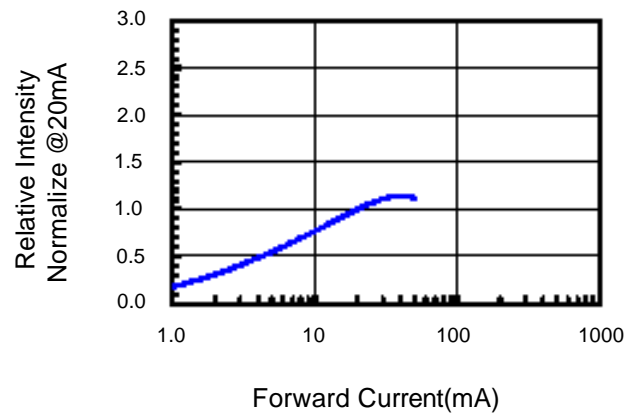

Fig.3 Forward Voltage vs. Temperature

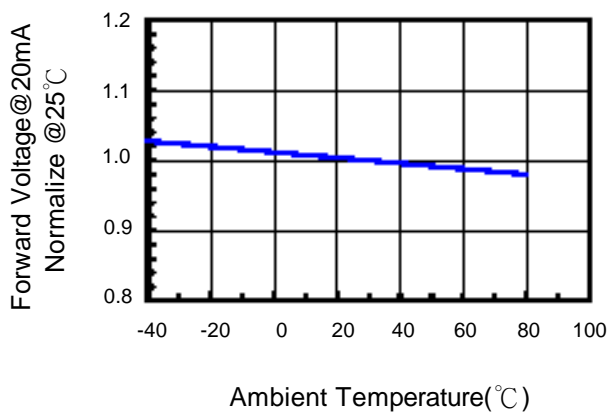

Fig.4 Relative Intensity vs. Temperature

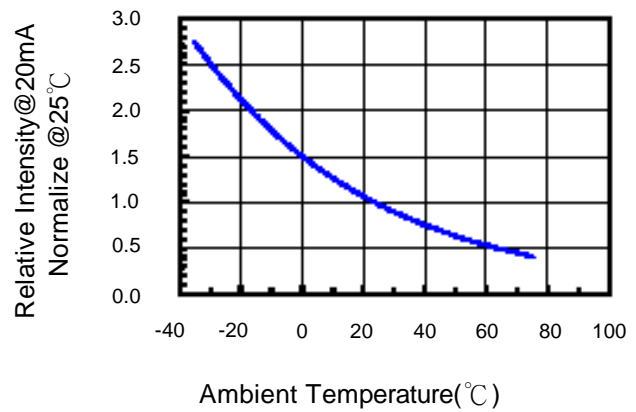
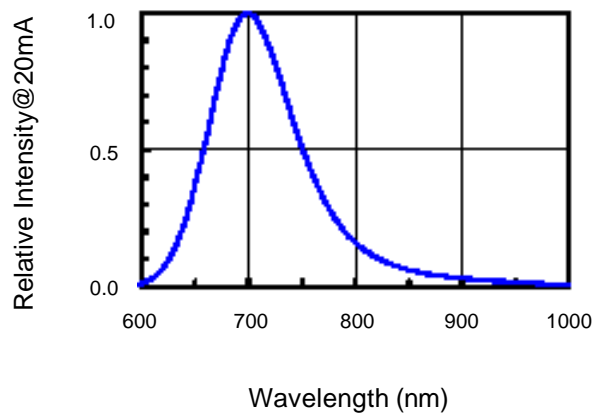

Fig.5 Relative Intensity vs. Wavelength





Reliability Test:

| Test Item                           | Test Condition   | Description   | Reference Standard   |
|-------------------------------------|--|---|--|
| Operating Life Test                 | 1.Under Room Temperature<br>2.If=10mA<br>3.t=1000 hrs (-24hrs, +72hrs) | This test is conducted for the purpose of determining the resistance of a part in electrical and thermal stressed.  | MIL-STD-750: 1026<br>MIL-STD-883: 1005<br>JIS C 7021: B-1                      |
| High Temperature Storage Test       | 1.Ta=105 °C ±5°C<br>2.t=1000 hrs (-24hrs, +72hrs)                      | The purpose of this is the resistance of the device which is laid under condition of high temperature for hours.  | MIL-STD-883:1008<br>JIS C 7021: B-10   |
| Low Temperature Storage Test        | 1.Ta=-40 °C ±5°C<br>2.t=1000 hrs (-24hrs, +72hrs)                      | The purpose of this is the resistance of the device which is laid under condition of low temperature for hours.   | JIS C 7021: B-12   |
| High Temperature High Humidity Test | 1.Ta=65 °C ±5°C<br>2.RH=90%~95%<br>3.t=240hrs ±2hrs                    | The purpose of this test is the resistance of the device under tropical for hours.  | MIL-STD-202:103B<br>JIS C 7021: B-11   |
| Thermal Shock Test                  | 1.Ta=105 °C ±5°C & -40 °C ±5°C<br>(10min) (10min)<br>2.total 10 cycles | The purpose of this is the resistance of the device to sudden extreme changes in high and low temperature.  | MIL-STD-202: 107D<br>MIL-STD-750: 1051<br>MIL-STD-883: 1011                    |
| Solder Resistance Test              | 1.T.Sol=260 °C ±5°C<br>2.Dwell time= 10 ±1sec.                         | This test intended to determine the thermal characteristic resistance of the device to sudden exposures at extreme changes in temperature when soldering the lead wire. | MIL-STD-202: 210A<br>MIL-STD-750: 2031<br>JIS C 7021: A-1                      |
| Solderability Test                  | 1.T.Sol=230 °C ±5°C<br>2.Dwell time=5 ±1sec                            | This test intended to see soldering well performed or not.  | MIL-STD-202: 208D<br>MIL-STD-750: 2026<br>MIL-STD-883: 2003<br>JIS C 7021: A-2 |