

PLEASE CHECK WWW.MOLEX.COM FOR LATEST PART INFORMATION

Part Number: [0512423002](#)
Status: **Active**
Overview: microclasp
Description: 2.00mm (.079") Pitch MicroClasp™ Wire-to-Board Receptacle Housing, Positive Lock, Dual Row, With Terminal Retainer Option, 30 circuits, Red Color Housing

Documents:

[3D Model](#) [Product Specification PS-51242-002 \(PDF\)](#)
[Drawing \(PDF\)](#) [RoHS Certificate of Compliance \(PDF\)](#)
[Product Specification PS-51242-001 \(PDF\)](#)

General

Product Family Crimp Housings
 Series [51242](#)
 Overview [microclasp](#)
 Product Name MicroClasp™

Physical

Circuits (maximum) 30
 Color - Resin Red
 Gender Female
 Glow-Wire Compliant No
 Lock to Mating Part Yes
 Material - Resin Nylon
 Number of Rows 2
 Packaging Type Bag
 Panel Mount No
 Pitch - Mating Interface (in) 0.079 In
 Pitch - Mating Interface (mm) 2.00 mm
 Stackable No
 Temperature Range - Operating -25°C to +85°C

Electrical

Current - Maximum per Contact 3A

Material Info

Reference - Drawing Numbers

Product Specification PS-51242-001, PS-51242-002, RPS-51242-003, RPS-51242-004, RPS-51242-005
 Sales Drawing SD-51242-002

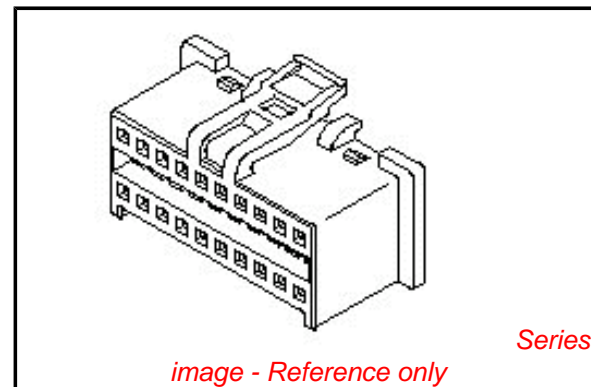

image - Reference only

EU RoHS

ELV and RoHS Compliant
REACH SVHC
 Not Reviewed
Halogen-Free
Status

China RoHS



Not Reviewed

Need more information on product environmental compliance?

Email productcompliance@molex.com
 For a multiple part number RoHS Certificate of Compliance, [click here](#)

Please visit the [Contact Us](#) section for any non-product compliance questions.

Search Parts in this Series

[51242Series](#)

Mates With

[55763](#)

Use With

[55767](#), [56134](#)

DWG. NO. SD-51242-002

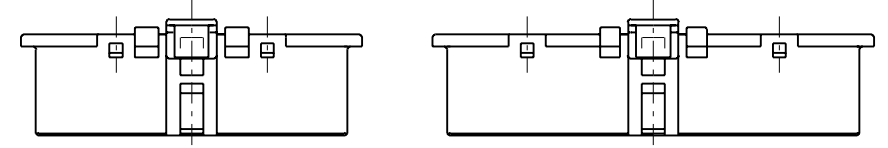
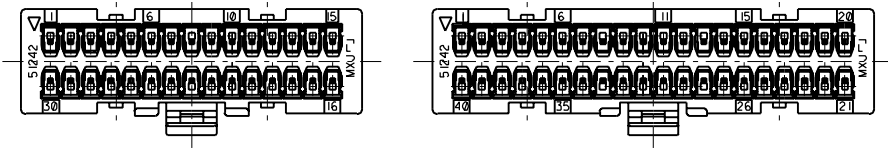
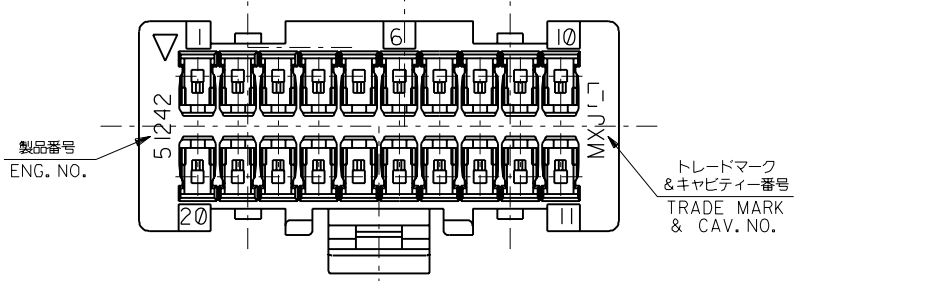

VIEW OF 30, 40 CIRCUIT (2:1)

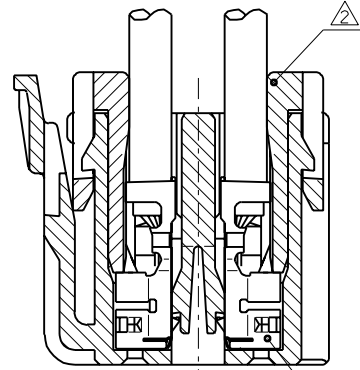
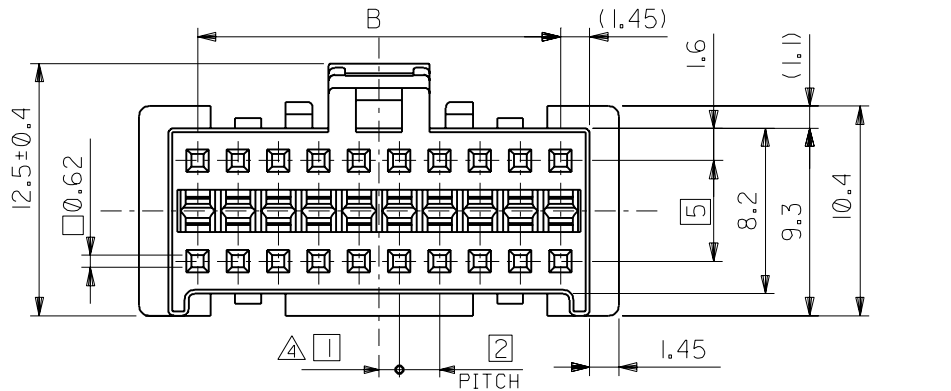
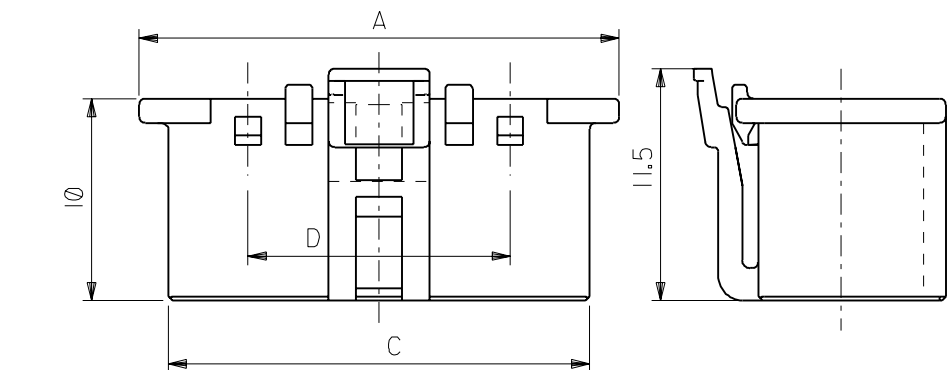

TERMINAL & RETAINER ASSEMBLY DRAWING SCALE 5:1

注記
NOTES

- △1 適合ターミナル : 56134シリーズ
APPLICABLE TERMINAL : 56134 SERIES
- △2 適合リテーナー : 55767シリーズ
APPLICABLE RETAINER : 55767 SERIES
- 3. 嵌合相手 : 55763シリーズ
MATE WITH : 55763 SERIES
(全極数/2) = 偶数の場合に適用。
APPLY FOR (CIRCUIT/2)=EVEN
- △5 製品番号
MATERIAL NO.

51242-**0*	ナチュラル(白) NATURAL(WHITE)	0
極数CIRCUIT SIZE	色COLOR	赤 RED
		2

25	40.9	38	43.8	51242-400*	40
15	30.9	28	33.8	51242-300*	30
13	20.9	18	23.8	51242-200*	20
D	C	B	A	△5 MATERIAL NO.	CKT.

DO NOT SCALE DRAWING

064NO. DRWN: CH'K: APPR: 063NO. DRWN: CH'K: APPR: 062NO. DRWN: CH'K: APPR: REVISED 061NO. J2002-0125 DRWN: N.ITO '01/08/02 CH'K: K.ASAKAWA APPR: T.YAMAGUCHI RELEASED 060NO. JC2001-0805 DRWN: N.ITO '01/04/02 CH'K: T.YAMAGUCHI APPR: M.FUKUSHIMA	MATERIAL 材料 ポリアミド (PA66)、ガラス入り、 GLASS FILLED 66 NYLON, UL94V-0, 色: 表参照 COLOR: SEE CHART	GENERAL TOLERANCES: (UNLESS SPECIFIED) 一般公差 10 UNDER 未満 ±0.2 10 OVER 以上 30 UNDER 未満 ±0.25 30 OVER 以上 ±0.3 ANGLE 角度 ±3°	SCALE 4 : 1 DESIGN UNITS <input checked="" type="checkbox"/> mm <input type="checkbox"/> INCH PROJECTION <input checked="" type="checkbox"/> FIRST ANGLE DRAWN BY & DATE N.ITO '01/04/02 CHECKED BY & DATE K.ASAKAWA '01/08/02 APPROVED BY & DATE T.YAMAGUCHI '01/08/02 CAD FILENAME 51242002.S01	MODEL NO. 51242-**0* DIMENSIONS: <input type="checkbox"/> mm <input type="checkbox"/> INCH <input checked="" type="checkbox"/> mm ONLY SHT 1 REV REVISE ON CAD ONLY	TITLE: 2.0mm W+B DUAL CONN RECEPTACLE HOUSING MOLEX MOLEX INCORPORATED MATERIAL NO. SEE CHART DRAWING NO. SD-51242-002 SHEET NO. 1 OF 1