

## 150KHz, 1.5A PWM Buck DC/DC Converter

### ■ Features

- Output voltage: 3.3V and adjustable output version
- Adjustable version output voltage range, 1.23V to 18V+4%
- 150KHz  $\pm 15\%$  fixed switching frequency
- Voltage mode non-synchronous PWM control
- Thermal-shutdown and current-limit protection
- Operating voltage can be up to 22V
- Output load current: 1.5A
- SIP-4L **Pb-Free** package
- Low power standby mode
- Built-in switching transistor on chip
- Very Low Cost

### ■ Applications

- Simple High-efficiency step-down regulator
- On-card switching regulators
- Positive to negative converter

### ■ Pin Assignments

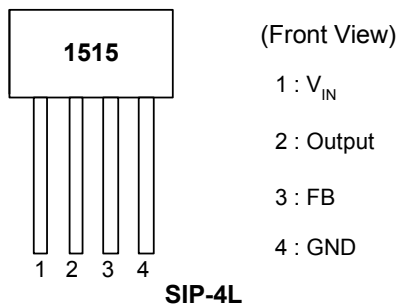

### ■ General Description

The AP1515 series are monolithic IC designed for a step-down DC/DC converter, and own the ability of driving a 1.5A load without additional transistor component. Due to reducing the number of external component, the board space can be saved easily. The external shutdown function can be controlled by logic level and then come into standby mode. The internal compensation makes feedback control have good line and load regulation without external design. Regarding protected function, thermal shutdown is to prevent over temperature operating from damage, and current limit is against over current operating of the output switch. If current limit function occurred and  $V_{FB}$  is down to 0.5V below, the switching frequency will be reduced. The AP1515 series operates at a switching frequency of 150KHz thus allowing smaller sized filter components than what would be needed with lower frequency switching regulators. Other features include a guaranteed  $\pm 4\%$  tolerance on output voltage under specified input voltage and output load conditions, and  $\pm 15\%$  on the oscillator frequency. The output version included fixed 3.3V and an adjustable type. The packages are available in a standard 4-lead SIP-4L package.

### ■ Pin Descriptions

Name	Description
$V_{IN}$	Operating voltage input
Output	Switching output
FB	Output voltage feedback control
GND	Ground

## 150KHz, 1.5A PWM Buck DC/DC Converter

### ■ Ordering Information

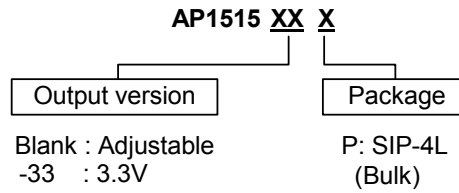

### ■ Block Diagram

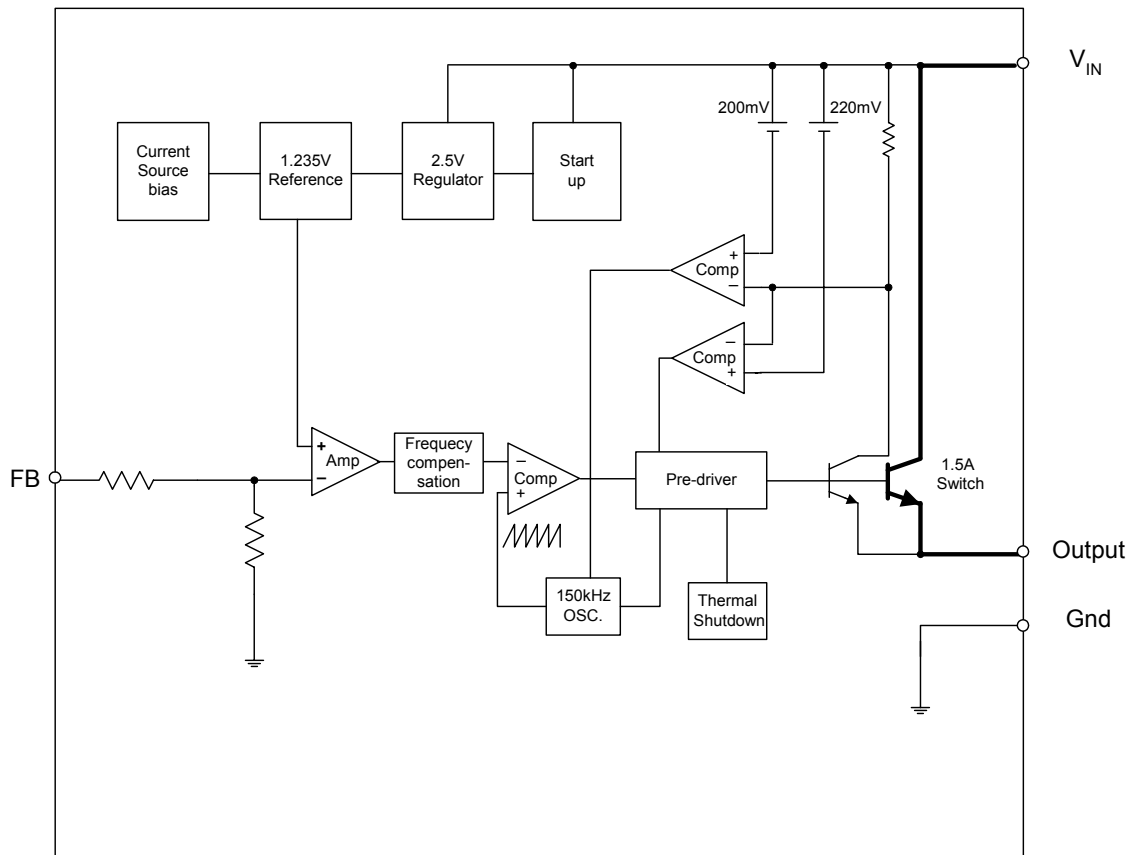



## 150KHz, 1.5A PWM Buck DC/DC Converter

### ■ Absolute Maximum Ratings

Symbol	Parameter	Rating	Unit
V <sub>CC</sub>	Supply Voltage	+24	V
V <sub>SD</sub>	ON/OFF Pin input voltage	-0.3 to +18	V
V <sub>FB</sub>	Feedback Pin voltage	-0.3 to +18	V
V <sub>OUT</sub>	Output voltage to Ground	-1	V
P <sub>D</sub>	Power dissipation	Internally limited	W
T <sub>ST</sub>	Storage temperature	-65 to +150	°C
T <sub>OP</sub>	Operating temperature	-40 to +125	°C
V <sub>OP</sub>	Operating voltage	+4.5 to +22	V

### ■ Electrical Characteristics (All Output Voltage Versions)

Unless otherwise specified, V<sub>IN</sub>= 12V for 3.3V, 5V, adjustable version and V<sub>IN</sub>=18V for the 12V version. I<sub>LOAD</sub> = 0.5A

Symbol	Parameter	Conditions	Min.	Typ.	Max.	Unit
I <sub>FB</sub>	Feedback bias current	V <sub>FB</sub> =1.3V (Adjustable version only)	-	-10	-50 <b>-100</b>	nA
F <sub>OSC</sub>	Oscillator frequency		127 <b>110</b>	150	173 <b>173</b>	KHz
F <sub>SCP</sub>	Oscillator frequency of short circuit protect	When current limit occurred and V <sub>FB</sub> < 0.5V, Ta=25°C	5	15	25	KHz
V <sub>SAT</sub>	Saturation voltage	I <sub>OUT</sub> =2A No outside circuit V <sub>FB</sub> =0V force driver on	-	1.25	1.4 <b>1.5</b>	V
DC	Max. Duty Cycle (ON)	V <sub>FB</sub> =0V force driver on	-	100	-	%
	Min. Duty Cycle (OFF)	V <sub>FB</sub> =12V force driver off	-	0	-	
I <sub>CL</sub>	Current limit	Peak current No outside circuit V <sub>FB</sub> =0V force driver on	2	-	-	A
I <sub>L</sub>	Output = 0	Output leakage current No outside circuit V <sub>FB</sub> =12V force driver off V <sub>IN</sub> =22V	-	-	-200	uA
	Output = -1		-	-5		
I <sub>Q</sub>	Quiescent Current	V <sub>FB</sub> =12V force driver off	-	5	10	mA
I <sub>STBY</sub>	Standby Quiescent Current	ON/OFF pin=5V V <sub>IN</sub> =22V	-	70	150 <b>200</b>	uA
θ <sub>JC</sub>	Thermal Resistance	Junction to case	-	30	-	°C/W
θ <sub>JA</sub>	Note 1	Junction to ambient	-	100	-	°C/W

Part Number	Symbol	Parameter	Conditions	Typ.	Limit	Unit
AP1515-ADJ	V <sub>FB</sub>	Output Feedback	4.5V ≤ V <sub>IN</sub> ≤ 22V 0.2A ≤ I <sub>LOAD</sub> ≤ 1.5A V <sub>OUT</sub> programmed for 3V	1.23	1.193/ <b>1.18</b> 1.267/ <b>1.28</b>	V V <sub>MIN</sub> V <sub>MAX</sub>
	η	Efficiency	V <sub>IN</sub> = 12V, I <sub>LOAD</sub> =1.5A	78		%
AP1515-3.3V	V <sub>OUT</sub>	Output voltage	4.75V ≤ V <sub>IN</sub> ≤ 22V 0.2A ≤ I <sub>LOAD</sub> ≤ 1.5A	3.3	3.168/ <b>3.135</b> 3.432/ <b>3.465</b>	V V <sub>MIN</sub> V <sub>MAX</sub>
	η	Efficiency	V <sub>IN</sub> = 12V, I <sub>LOAD</sub> =1.5A	80		%

Specifications with **boldface type** are for full operating temperature range, the other type are for T<sub>J</sub>=25°C.

**Note 1:** Pin 4(GND) (< 1 mm length) & direct connect to internal GND layer.

## 150KHz, 1.5A PWM Buck DC/DC Converter

### ■ Typical Application Circuit

#### (1) Fixed Type Circuit

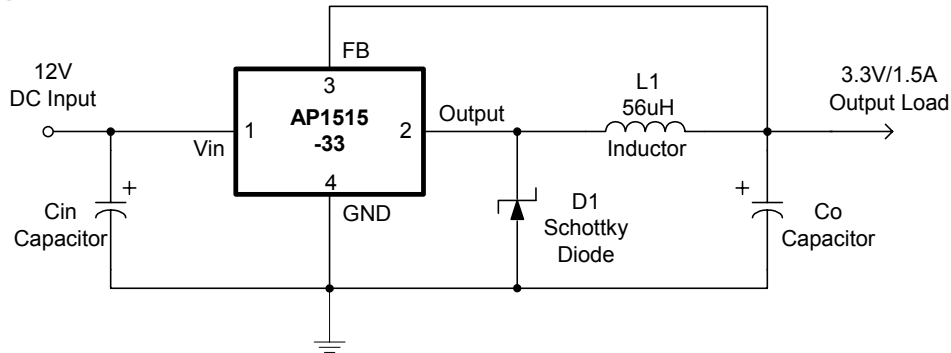

#### (2) Adjustable Type Circuit

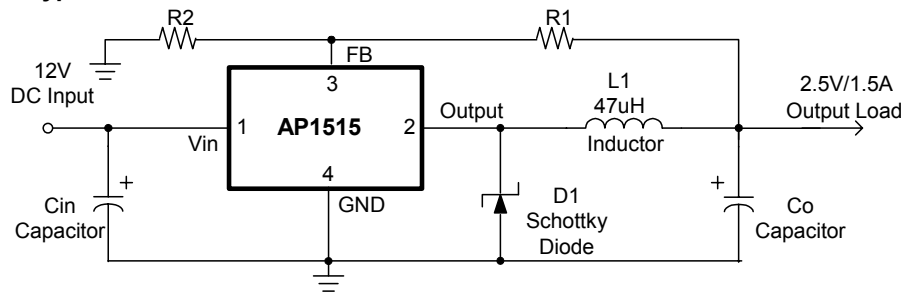

$$V_{out} = V_{FB} \times \left(1 + \frac{R1}{R2}\right)$$

$$V_{FB} = 1.23V$$

$$R2 = 1K \sim 3K$$

### ■ Typical Performance Characteristics

AP1515 Output Voltage v.s. Temperature  
(Vin=12V, Io=1.5A)

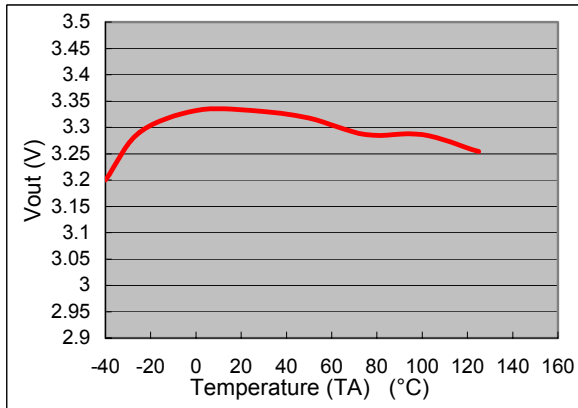

AP1515 Efficiency v.s. Temperature  
(Vin=12V, Vout=3.3V, Io=1.5A)

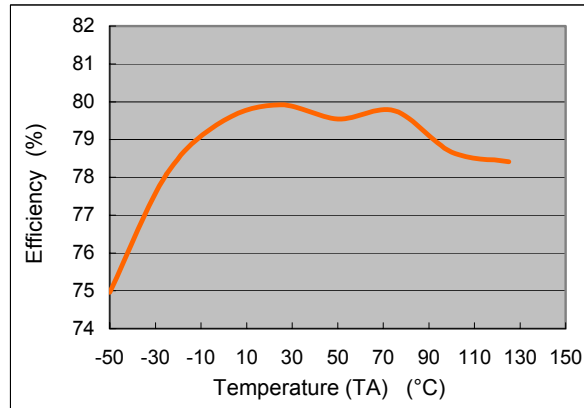

### ■ Typical Performance Characteristics (Continued)

**AP1515 Saturation Voltage v.s. Temperature**  
(Vcc=12V, Vfb=0V, VSD=0)

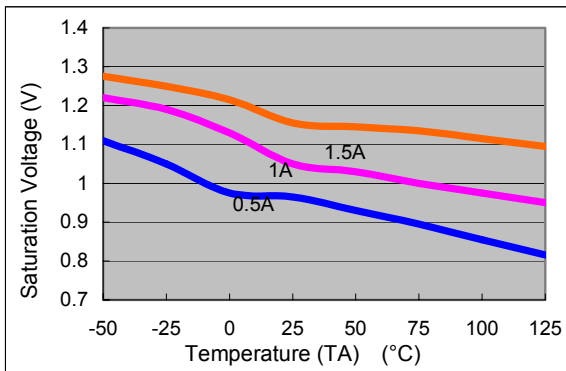

**AP1515 Switch Current Limit v.s. Temperature**  
(Vcc=12V, Vfb=0V)

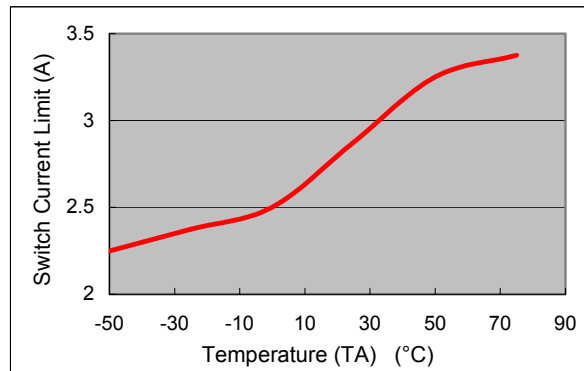

**AP1515 Supply Current v.s. Temperature**  
(Vcc=12V, No Load, Von/off =0V(Switch ON), Von/off =5V(Switch OFF))

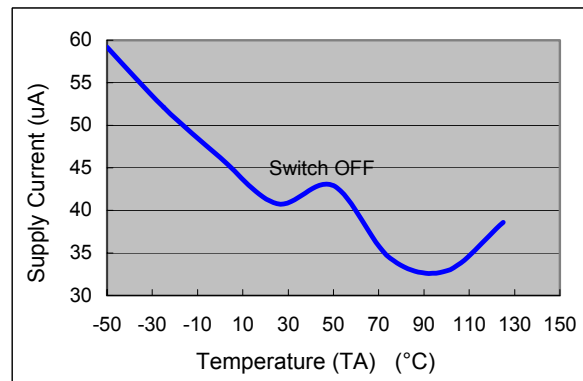
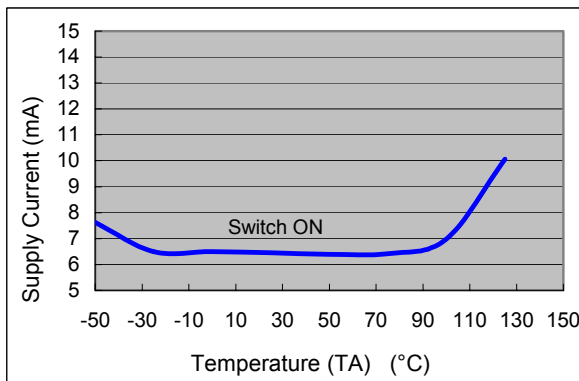

**AP1515 Frequency v.s. Temperature**  
(Vcc=12V, Io=500mA, Vout=5V)

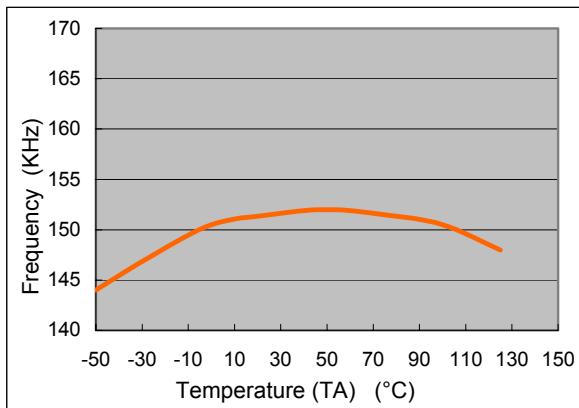

**AP1515 Feedback Current v.s. Temperature**  
(Vcc=12V, Vout=5V, Vfb=1.3V)

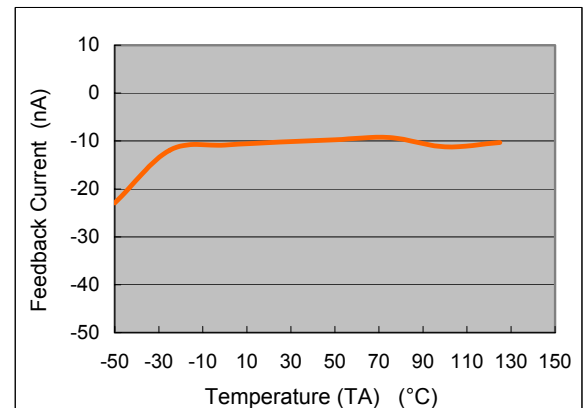

## 150KHz, 1.5A PWM Buck DC/DC Converter

### ■ Function Description

#### Pin Functions

##### $+V_{IN}$

This is the positive input supply for the IC switching regulator. A suitable input bypass capacitor must be present at this pin to minimize voltage transients and to supply the switching currents needed by the regulator.

##### Ground

Circuit ground.

##### Output

Internal switch. The voltage at this pin switches between  $(+V_{IN} - V_{SAT})$  and approximately  $-0.5V$ , with a duty cycle of approximately  $V_{OUT} / V_{IN}$ . To minimize coupling to sensitive circuitry, the PC board copper area connected to this pin should be kept a minimum.

##### Feedback

Senses the regulated output voltage to complete the feedback loop.

### ■ Marking Information

#### SIP-4L

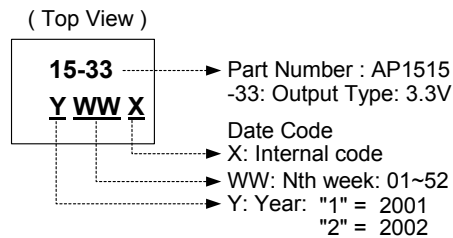
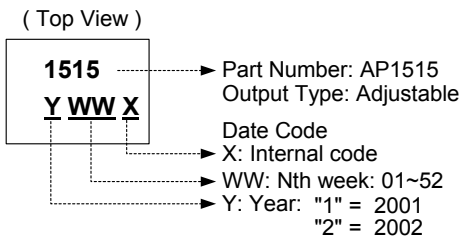

### ■ Package Information

Package Type: SIP-4L

