

# Silicon Double Balanced HMIC™ Mixer, 1300 - 1900 MHz

MA4EX180H-1225T

## Features

- SOT-25 Low Cost Miniature Plastic Package
- 6.5 dB Typical Conversion Loss at 1550 MHz
- 7.6 dB Typical Conversion Loss at 1800 MHz
- +13 to +17 dBm LO Drive
- HMIC™ Patented Process
- Silicon High Barrier Schottky Diodes
- DC - 500 MHz IF Bandwidth

## Description

M/A-COM's MA4EX180H-1225T is a silicon monolithic 1300-1900 MHz double balanced mixer in a low cost miniature surface mount SOT-25 package. The die uses M/A-COM's unique HMIC™ silicon/glass process to achieve low loss passive elements while retaining the advantages of high barrier silicon Schottky diodes.

## Applications

These mixers are well suited for high volume wireless and cellular applications where small size and repeatability are required. Typical applications include frequency conversion, modulation, and demodulation for receivers and transmitters in both portable cellular and base station applications.

## Absolute Maximum Ratings<sup>1</sup>

Parameter	Absolute Maximum
Operating Temperature	-65 °C to +125 °C
Storage Temperature	-65 °C to +150 °C
Incident LO Power	+20 dBm
Incident RF Power	+20 dBm

1. Exceeding these limits may cause permanent damage.

## SOT-25 Package Outline (Topview)

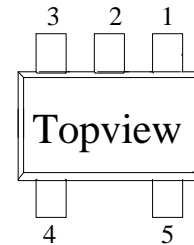

## PIN Configuration

PIN	Function	PIN	Function
1	GND	4	RF
2	GND	5	LO
3	IF		

## Functional Schematic

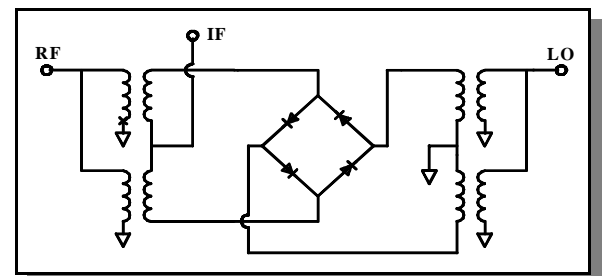

Electrical Specifications:  $T_A = + 25 \text{ }^\circ\text{C}$

Parameter	Frequency Range	Test Conditions	Units	Min.	Typ.	Max.
Conversion Loss	1550 MHz	LO Drive = +15 dBm	dB		6.5	7.5
	1300-1900 MHz	RF = -10 dBm, IF = 60 MHz	dB		7.5	9.5
L - R Isolation	1550 MHz	LO Drive = +15 dBm	dB		27.0	
	1300-1900 MHz	RF Level = -10 dBm	dB		18.6	
L - I Isolation	1550 MHz	LO Drive = +15 dBm	dB		28.9	
	1300-1900 MHz	RF Level = -10 dBm	dB		24.0	
R - I Isolation	1550 MHz	LO Drive = +15 dBm	dB		15.8	
	1300-1900 MHz	RF Level = -10 dBm	dB		16.9	
RF VSWR	1550 MHz	LO Drive = +15 dBm			1.4:1	
	1300-1900 MHz	RF Level = -10 dBm			2.1:1	
IF VSWR	DC - 500 MHz	LO Drive = +15 dBm RF Level = -10 dBm			1.5:1	
Input IP3	1550 MHz	LO Drive = +15 dBm	dBm	19.5	23.0	
	1300-1900 MHz	IF = 60 MHz	dBm	17.5	22.0	
Input 1 dB Compression	1550 MHz	LO Drive = +15 dBm	dBm	7.5	8.5	
	1300-1900 MHz	IF = 60 MHz	dBm	7.5	9.5	
IF 1 dB Bandwidth			MHz	0	500.0	

Typical Performance Curves (LO Drive = +15 dBm, RF = -10 dBm, IF = 60 MHz)

Conversion Loss

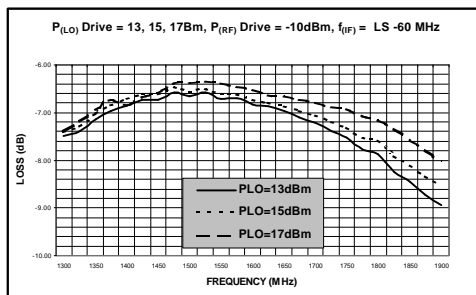

Isolation

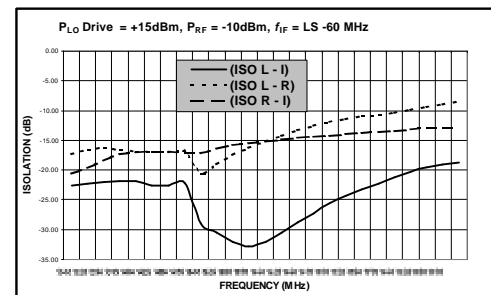

RF and IF VSWR

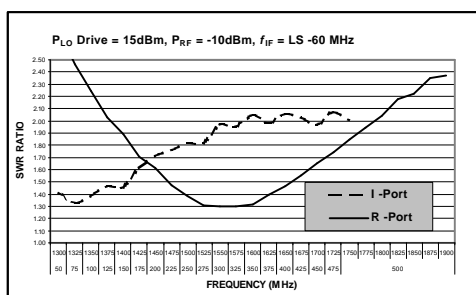

Third Order Intercept and Input 1 dB Compression Power

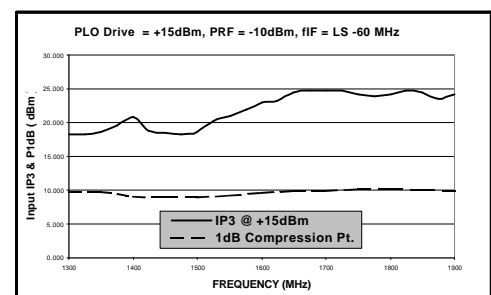

Specifications subject to change without notice.

- North America: Tel. (800) 366-2266
- Asia/Pacific: Tel. +81-44-844-8296, Fax +81-44-844-8298
- Europe: Tel. +44 (1344) 869 595, Fax +44 (1344) 300 020

Visit [www.macom.com](http://www.macom.com) for additional data sheets and product information.

SOT-25 Package Outline<sup>1,2</sup>

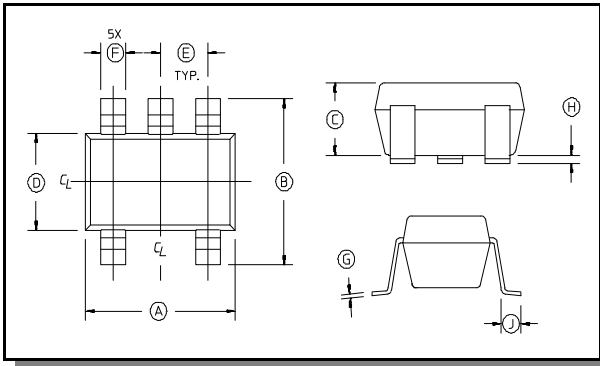

1. Dimensions do not include mold flash, protrusion or gate burrs which shall not exceed 0.0098 in (.25mm) per side.
2. Lead Coplanarity is 0.003 (0.08) max.

SOT-25 Dimensions

Dim	Inches		Millimeters	
	Min.	Max.	Min.	Max.
A		.122	2.70	3.10
B	.100	.118	2.54	3.00
C	—	.051	—	1.30
D	.063 REF.		1.60 REF.	
E	.032	.043	.80	1.10
F	.014	.020	.35	.50
G	.003	—	.08	—
H	.000	.006	.00	.15
J	.018 REF.		.45 REF.	

Ordering Information

Part Number	Package
MA4EX180H-1225T	Tape and Reel

Specifications subject to change without notice.

- North America: Tel. (800) 366-2266
- Asia/Pacific: Tel.+81-44-844-8296, Fax +81-44-844-8298
- Europe: Tel. +44 (1344) 869 595, Fax+44 (1344) 300 020

Visit [www.macom.com](http://www.macom.com) for additional data sheets and product information.