

flowPACK 0 3rd gen

1200V/25A

**Features**

- 2 clip housing in 12mm and 17mm height
- Trench Fieldstop IGBT<sup>4</sup> technology
- Compact and low inductance design
- Built-in NTC

**Target Applications**

- Motor Drives
- Power Generation
- UPS

**Types**

- V23990-P869-F49-PM: 17mm height
- V23990-P869-F48-PM: 12mm height

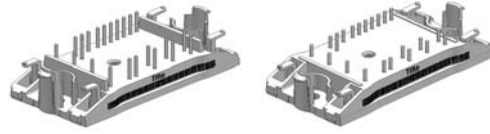
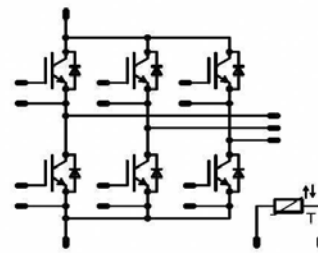
**flow0 housing**

**Schematic**

## Maximum Ratings

 T<sub>j</sub>=25°C, unless otherwise specified

Parameter	Symbol	Condition	Value	Unit
<b>Inverter Transistor</b>				
Collector-emitter voltage	V <sub>CE</sub>		1200	V
DC collector current	I <sub>C</sub>	T <sub>j</sub> =T <sub>jmax</sub> T <sub>h</sub> =80°C T <sub>c</sub> =80°C	28	A
Repetitive peak collector current	I <sub>Cpulse</sub>	t <sub>p</sub> limited by T <sub>jmax</sub>	75	A
Power dissipation per IGBT	P <sub>tot</sub>	T <sub>j</sub> =T <sub>jmax</sub> T <sub>h</sub> =80°C T <sub>c</sub> =80°C	73	W
Gate-emitter peak voltage	V <sub>GE</sub>		±20	V
Short circuit ratings*	t <sub>SC</sub> V <sub>CC</sub>	T <sub>j</sub> ≤150°C V <sub>GE</sub> =15V	10 800	μs V
Maximum Junction Temperature	T <sub>jmax</sub>		175	°C

\* It is recommended to not exceed 1000 short circuit situations in the lifetime of the module and to allow at least 1s between short circuits

**Inverter Diode**

Peak Repetitive Reverse Voltage	V <sub>RRM</sub>	T <sub>j</sub> =25°C	1200	V
DC forward current	I <sub>F</sub>	T <sub>j</sub> =T <sub>jmax</sub> T <sub>h</sub> =80°C T <sub>c</sub> =80°C	27	A
Repetitive peak forward current	I <sub>FRM</sub>	t <sub>p</sub> limited by T <sub>jmax</sub>	50	A
Power dissipation per Diode	P <sub>tot</sub>	T <sub>j</sub> =T <sub>jmax</sub> T <sub>h</sub> =80°C T <sub>c</sub> =80°C	51	W
Maximum Junction Temperature	T <sub>jmax</sub>		175	°C

**Thermal properties**

Storage temperature	T <sub>stg</sub>		-40.....+125	°C
Operation junction temperature	T <sub>op</sub>		-40.....+T <sub>jmax</sub> -25	°C

### Maximum Ratings

T<sub>j</sub>=25°C, unless otherwise specified

Parameter	Symbol	Condition	Value	Unit
<b>Insulation properties</b>				
Insulation voltage	V <sub>is</sub>	t=2s DC voltage	4000	V
Creepage distance			min.12,7	mm
Clearance			min.12,7	mm

**Characteristic Values**

Parameter	Symbol	Conditions					Value			Unit	
		$V_{GE} [V]$ or $V_{GS} [V]$	$V_r [V]$ or $V_{CE} [V]$ or $V_{DS} [V]$	$I_c [A]$ or $I_F [A]$ or $I_D [A]$	$T_j$	Min	Typ	Max			
<b>Inverter Transistor</b>											
Gate emitter threshold voltage	$V_{GE(th)}$	VCE=VGE			0,00085	T <sub>J</sub> =25°C T <sub>J</sub> =150°C	5	5,8	6,5	V	
Collector-emitter saturation voltage	$V_{CE(sat)}$		15		25	T <sub>J</sub> =25°C T <sub>J</sub> =150°C		1,91 2,33	2,4	V	
Collector-emitter cut-off current incl. Diode	$I_{CES}$		0	1200		T <sub>J</sub> =25°C T <sub>J</sub> =150°C			10	μA	
Gate-emitter leakage current	$I_{GES}$		20	0		T <sub>J</sub> =25°C T <sub>J</sub> =150°C			200	nA	
Integrated Gate resistor	$R_{gint}$							none		Ω	
Turn-on delay time	$t_{d(on)}$	R <sub>gon</sub> =32Ω R <sub>goff</sub> =32Ω	±15	600	25	T <sub>J</sub> =25°C		130	ns		
Rise time	$t_r$					T <sub>J</sub> =150°C		127			
Turn-off delay time	$t_{d(off)}$					T <sub>J</sub> =25°C		26			
						T <sub>J</sub> =150°C		32			
Fall time	$t_f$					T <sub>J</sub> =25°C		220			
Turn-on energy loss per pulse	$E_{on}$	T <sub>J</sub> =25°C		286	mWs						
		T <sub>J</sub> =150°C		77							
Turn-off energy loss per pulse	$E_{off}$	T <sub>J</sub> =25°C		118	mWs						
		T <sub>J</sub> =150°C		2,001 3,002							
Input capacitance	$C_{ies}$							1430	pF		
Output capacitance	$C_{oss}$	f=1MHz	0	25	T <sub>J</sub> =25°C			115			
Reverse transfer capacitance	$C_{rss}$							85			
Gate charge	$Q_{Gate}$		15	960	25	T <sub>J</sub> =25°C			120	nC	
Thermal resistance chip to heatsink per chip	$R_{thJH}$	Thermal grease thickness≤50um λ = 0,61 W/mK							1,305	K/W	
<b>Inverter Diode</b>											
Diode forward voltage	$V_F$				25	T <sub>J</sub> =25°C T <sub>J</sub> =150°C		1,87 1,80	2,35	V	
Reverse leakage current	$I_R$					T <sub>J</sub> =25°C T <sub>J</sub> =150°C			10	μA	
Peak reverse recovery current	$I_{RRM}$	R <sub>gon</sub> =32Ω	±15	600	25	T <sub>J</sub> =25°C		18,3	ns		
Reverse recovery time	$t_{rr}$					T <sub>J</sub> =150°C		21,7			
						T <sub>J</sub> =25°C		360			
Reverse recovered charge	$Q_{rr}$					T <sub>J</sub> =150°C		588			μC
						T <sub>J</sub> =25°C		2,41			
Peak rate of fall of recovery current	$di(rec)max/dt$					T <sub>J</sub> =25°C T <sub>J</sub> =150°C		75 48	A/μs		
Reverse recovered energy	$E_{rec}$					T <sub>J</sub> =150°C		1,971	mWs		
Thermal resistance chip to heatsink per chip	$R_{thJH}$	Thermal grease thickness≤50um λ = 0,61 W/mK							1,851	K/W	
<b>Thermistor</b>											
Rated resistance	$R_{25}$	Tol. ±5%				T <sub>J</sub> =25°C	20,9	22	23,1	kΩ	
Deviation of R100	$\Delta R/R$	R100=1486Ω				T <sub>J</sub> =100°C		2,9		%/K	
Power dissipation	$P$					T <sub>J</sub> =25°C		210		mW	
B-value	$B_{(25/100)}$	Tol. ±3%				T <sub>J</sub> =25°C		4000		K	

## Output Inverter

**Figure 1** Output inverter IGBT

**Typical output characteristics**

$I_C = f(V_{CE})$

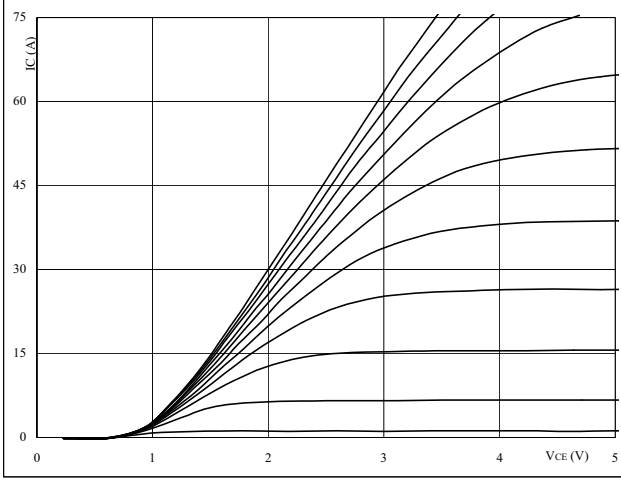
 $t_p = 250 \mu s$   
 $T_j = 25 \text{ } ^\circ C$   
 $V_{GE}$  from 7 V to 17 V in steps of 1 V

**Figure 2** Output inverter IGBT

**Typical output characteristics**

$I_C = f(V_{CE})$

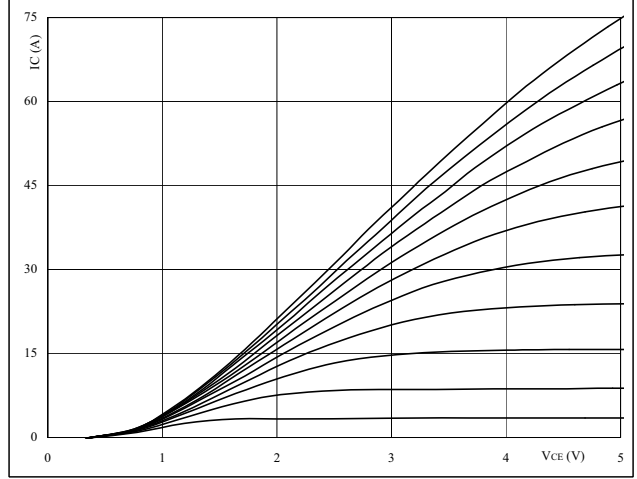
 $t_p = 250 \mu s$   
 $T_j = 150 \text{ } ^\circ C$   
 $V_{GE}$  from 7 V to 17 V in steps of 1 V

**Figure 3** Output inverter IGBT

**Typical transfer characteristics**

$I_C = f(V_{GE})$

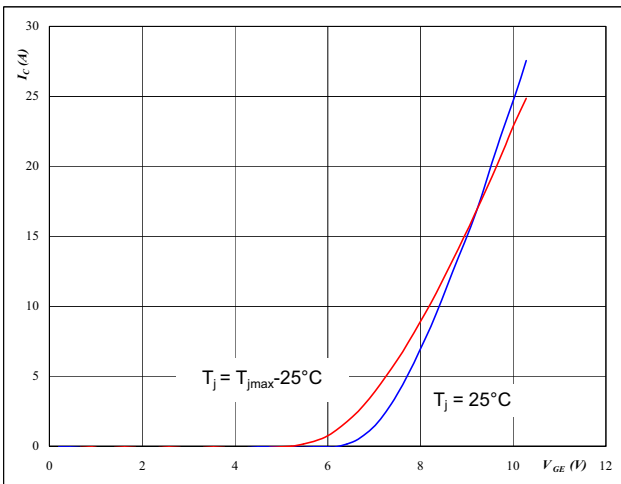
 $t_p = 250 \mu s$   
 $V_{CE} = 10 \text{ V}$ 
**Figure 4** Output inverter FRED

**Typical diode forward current as a function of forward voltage**

$I_F = f(V_F)$

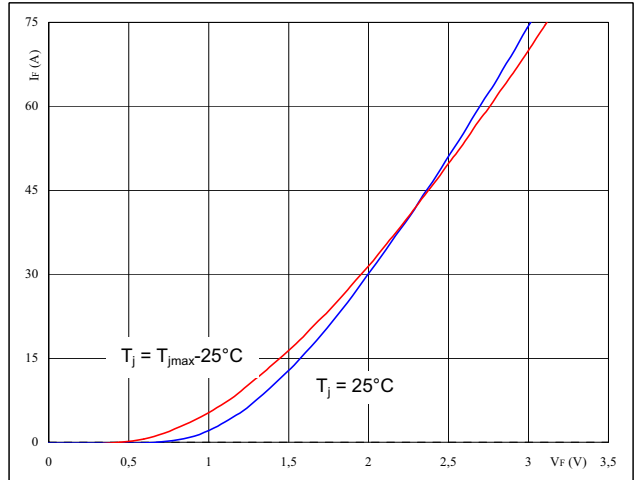

 $t_p = 250 \mu s$

## Output Inverter

**Figure 5** Output inverter IGBT

**Typical switching energy losses**  
 as a function of collector current

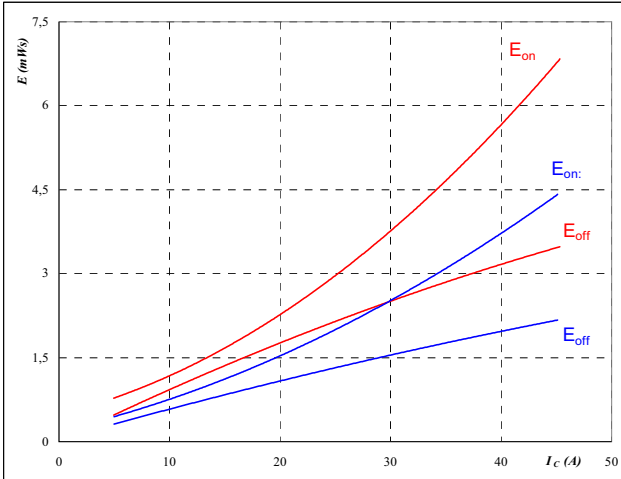
$$E = f(I_C)$$



inductive load

$T_J =$	25/150	°C
$V_{CE} =$	600	V
$V_{GE} =$	±15	V
$R_{gon} =$	32	Ω
$R_{goff} =$	32	Ω

**Figure 6** Output inverter IGBT

**Typical switching energy losses**  
 as a function of gate resistor

$$E = f(R_G)$$

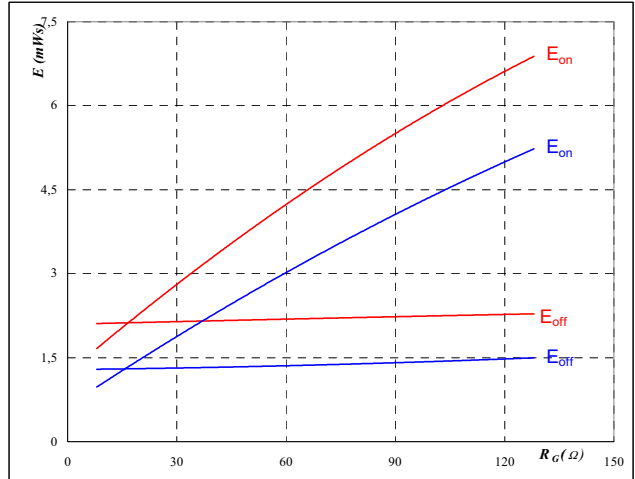

inductive load

$T_J =$	25/150	°C
$V_{CE} =$	600	V
$V_{GE} =$	±15	V
$I_C =$	25	A

**Figure 7** Output inverter IGBT

**Typical reverse recovery energy loss**  
 as a function of collector current

$$E_{rec} = f(I_C)$$

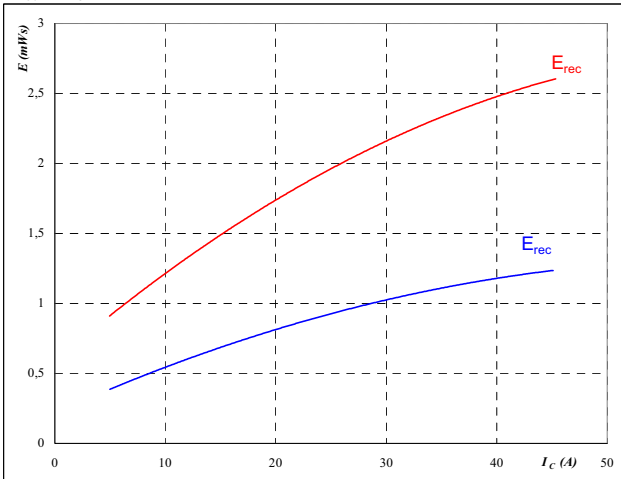

inductive load

$T_J =$	25/150	°C
$V_{CE} =$	600	V
$V_{GE} =$	±15	V
$R_{gon} =$	32	Ω

**Figure 8** Output inverter IGBT

**Typical reverse recovery energy loss**  
 as a function of gate resistor

$$E_{rec} = f(R_G)$$

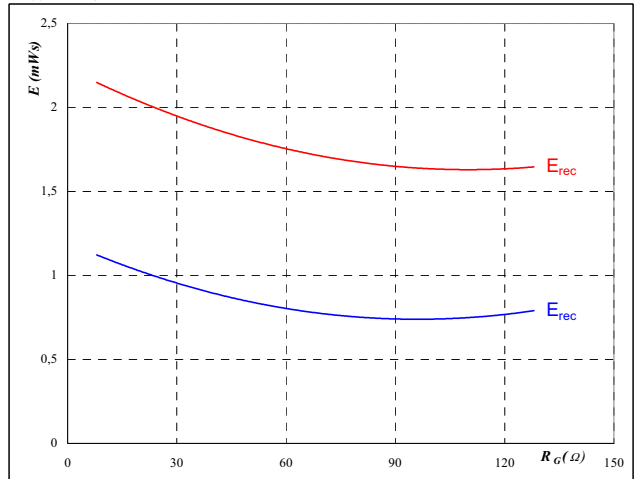

inductive load

$T_J =$	25/150	°C
$V_{CE} =$	600	V
$V_{GE} =$	±15	V
$I_C =$	25	A

## Output Inverter

**Figure 9** Output inverter IGBT

**Typical switching times as a function of collector current**

$t = f(I_C)$

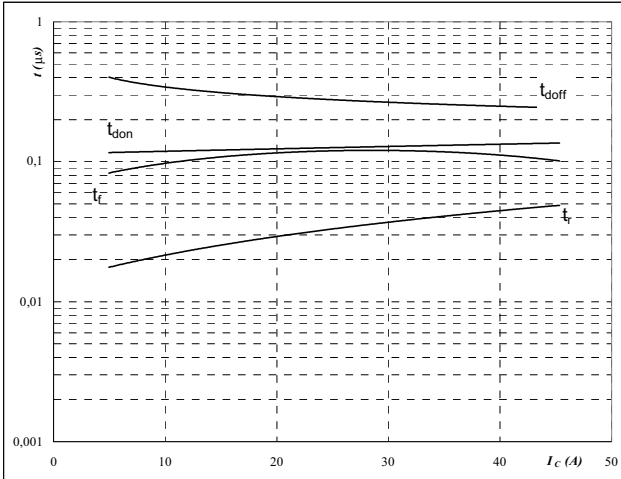

inductive load

$T_J =$	150	°C
$V_{CE} =$	600	V
$V_{GE} =$	±15	V
$R_{gon} =$	32	Ω
$R_{goff} =$	32	Ω

**Figure 10** Output inverter IGBT

**Typical switching times as a function of gate resistor**

$t = f(R_G)$

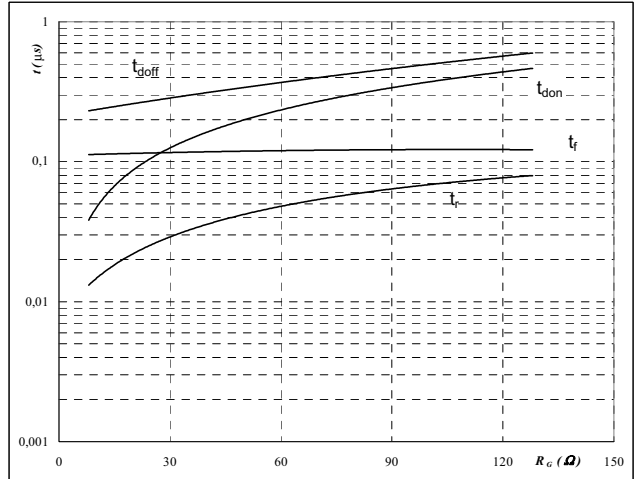

inductive load

$T_J =$	150	°C
$V_{CE} =$	600	V
$V_{GE} =$	±15	V
$I_C =$	25	A

**Figure 11** Output inverter FRED

**Typical reverse recovery time as a function of collector current**

$t_{rr} = f(I_C)$

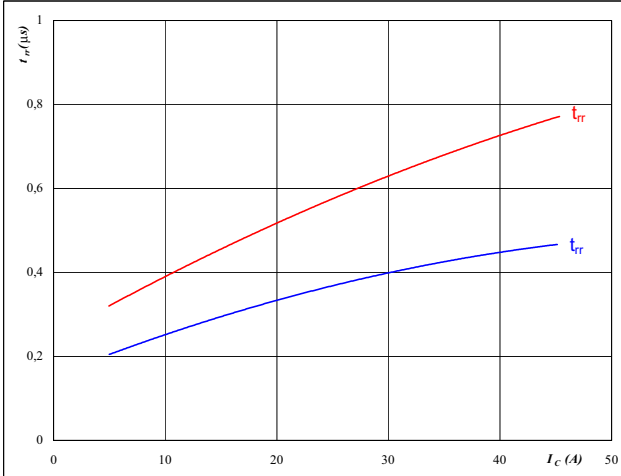

$T_J =$	25/150	°C
$V_{CE} =$	600	V
$V_{GE} =$	±15	V
$R_{gon} =$	32	Ω

**Figure 12** Output inverter FRED

**Typical reverse recovery time as a function of IGBT turn on gate resistor**

$t_{rr} = f(R_{gon})$

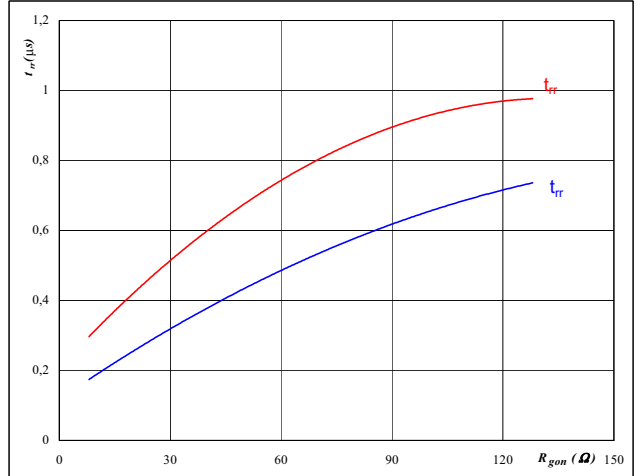

$T_J =$	25/150	°C
$V_R =$	600	V
$I_F =$	25	A
$V_{GE} =$	±15	V

## Output Inverter

**Figure 13** Output inverter FRED

Typical reverse recovery charge as a function of collector current

$$Q_{rr} = f(I_C)$$

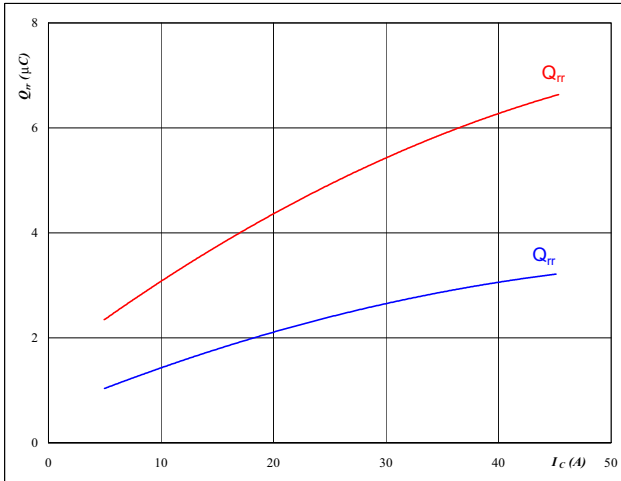

$T_J = 25/150$  °C  
 $V_{CE} = 600$  V  
 $V_{GE} = \pm 15$  V  
 $R_{gon} = 32$  Ω

**Figure 14** Output inverter FRED

Typical reverse recovery charge as a function of IGBT turn on gate resistor

$$Q_{rr} = f(R_{gon})$$

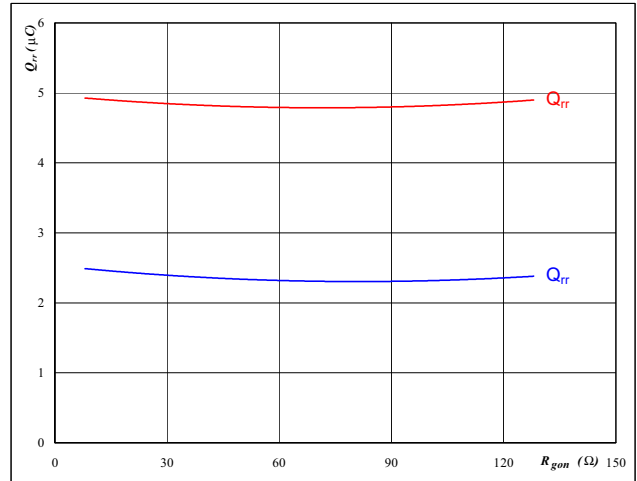

$T_J = 25/150$  °C  
 $V_R = 600$  V  
 $I_F = 25$  A  
 $V_{GE} = \pm 15$  V

**Figure 15** Output inverter FRED

Typical reverse recovery current as a function of collector current

$$I_{RRM} = f(I_C)$$

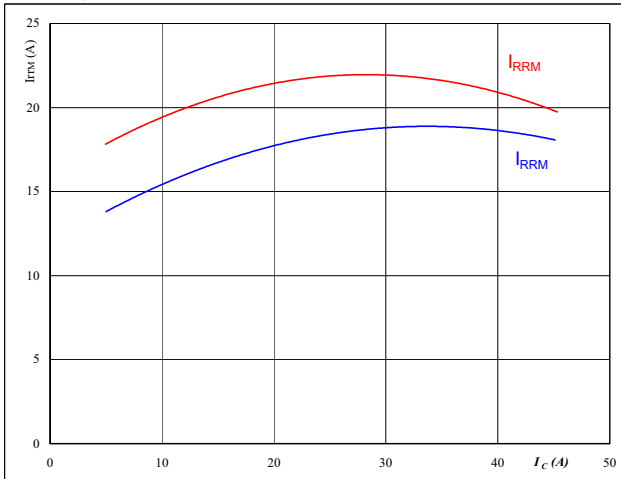

$T_J = 25/150$  °C  
 $V_{CE} = 600$  V  
 $V_{GE} = \pm 15$  V  
 $R_{gon} = 32$  Ω

**Figure 16** Output inverter FRED

Typical reverse recovery current as a function of IGBT turn on gate resistor

$$I_{RRM} = f(R_{gon})$$

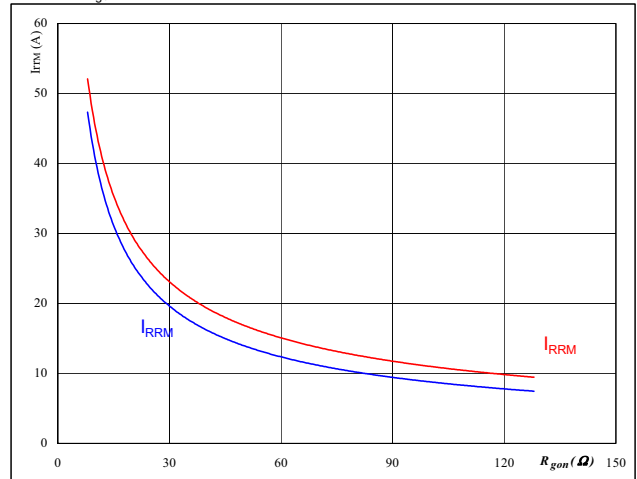

$T_J = 25/150$  °C  
 $V_R = 600$  V  
 $I_F = 25$  A  
 $V_{GE} = \pm 15$  V

### Output Inverter

Figure 17 Output inverter FRED

Typical rate of fall of forward and reverse recovery current as a function of collector current

$$di_o/dt, di_{rec}/dt = f(I_c)$$

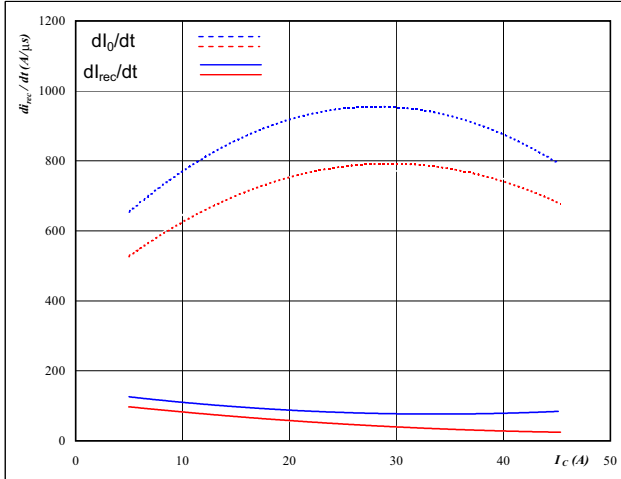

T<sub>J</sub> = 25/150 °C  
V<sub>CE</sub> = 600 V  
V<sub>GE</sub> = ±15 V  
R<sub>gon</sub> = 32 Ω

Figure 18 Output inverter FRED

Typical rate of fall of forward and reverse recovery current as a function of IGBT turn on gate resistor

$$di_o/dt, di_{rec}/dt = f(R_{gon})$$

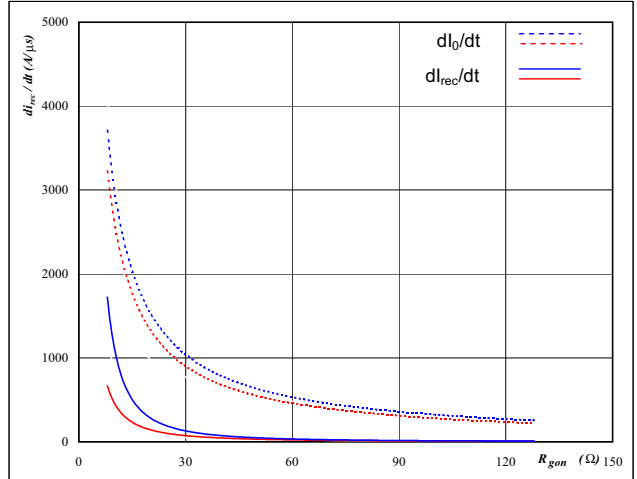

T<sub>J</sub> = 25/150 °C  
V<sub>R</sub> = 600 V  
I<sub>F</sub> = 25 A  
V<sub>GE</sub> = ±15 V

Figure 19 Output inverter IGBT

IGBT transient thermal impedance as a function of pulse width

$$Z_{thJH} = f(t_p)$$

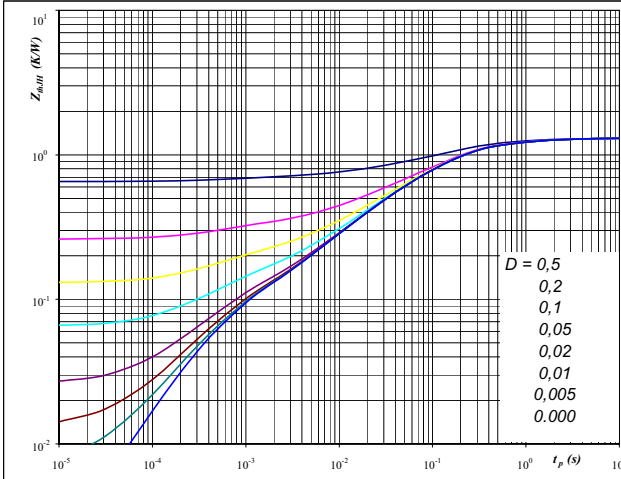

D = t<sub>p</sub> / T  
R<sub>thJH</sub> = 1,31 K/W

IGBT thermal model values

R (C/W)	Tau (s)
0,06	3,5E+00
0,18	6,2E-01
0,65	1,3E-01
0,27	2,3E-02
0,08	3,9E-03
0,07	4,6E-04

Figure 20 Output inverter FRED

FRED transient thermal impedance as a function of pulse width

$$Z_{thJH} = f(t_p)$$

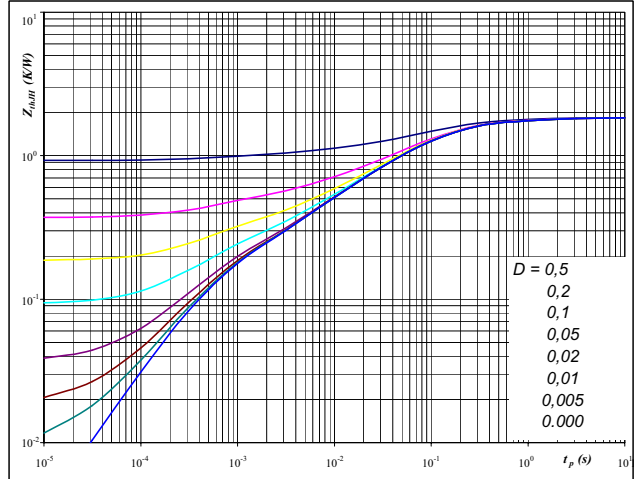

D = t<sub>p</sub> / T  
R<sub>thJH</sub> = 1,85 K/W

FRED thermal model values

R (C/W)	Tau (s)
0,04	9,4E+00
0,19	8,3E-01
0,80	1,3E-01
0,50	2,9E-02
0,19	4,5E-03
0,13	4,9E-04



## Output Inverter

**Figure 21** Output inverter IGBT

**Power dissipation as a function of heatsink temperature**

$$P_{tot} = f(T_h)$$

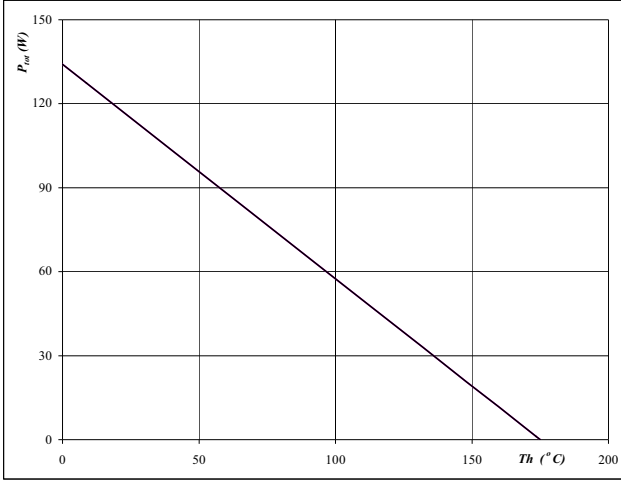
 $T_J = 175 \text{ } ^\circ\text{C}$ 
**Figure 22** Output inverter IGBT

**Collector current as a function of heatsink temperature**

$$I_C = f(T_h)$$

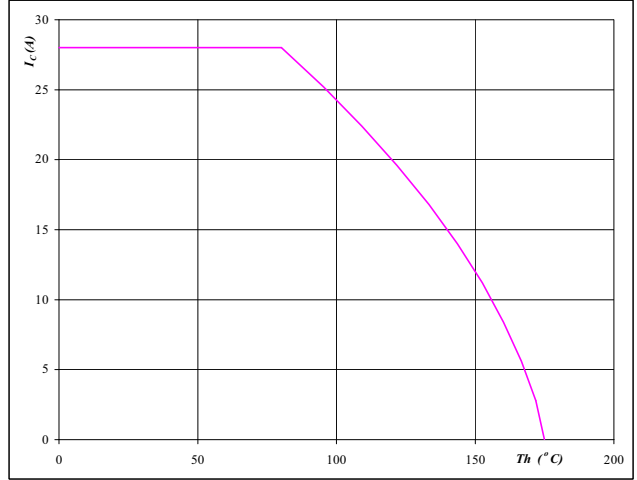
 $T_J = 175 \text{ } ^\circ\text{C}$   
 $V_{GE} = 15 \text{ V}$ 
**Figure 23** Output inverter FRED

**Power dissipation as a function of heatsink temperature**

$$P_{tot} = f(T_h)$$

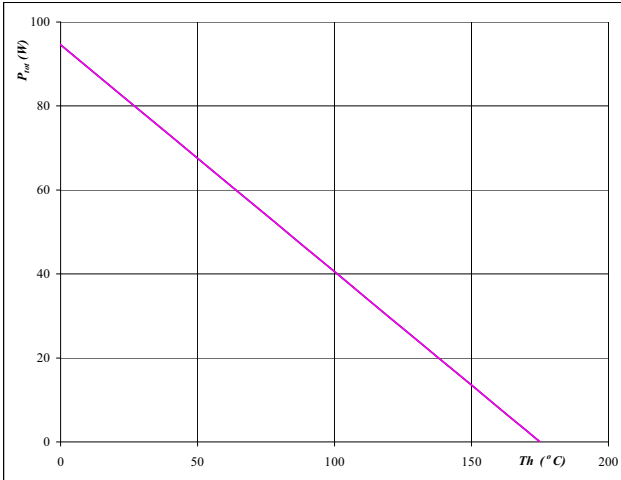
 $T_J = 175 \text{ } ^\circ\text{C}$ 
**Figure 24** Output inverter FRED

**Forward current as a function of heatsink temperature**

$$I_F = f(T_h)$$

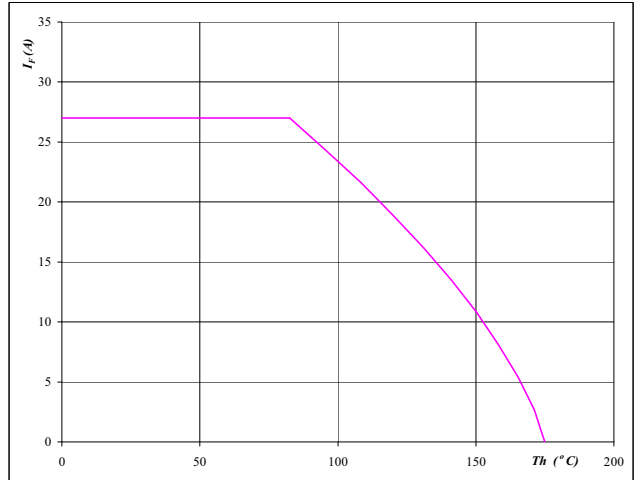
 $T_J = 175 \text{ } ^\circ\text{C}$

## Output Inverter

**Figure 25** Output inverter IGBT

Safe operating area as a function of collector-emitter voltage  
 $I_C = f(V_{CE})$

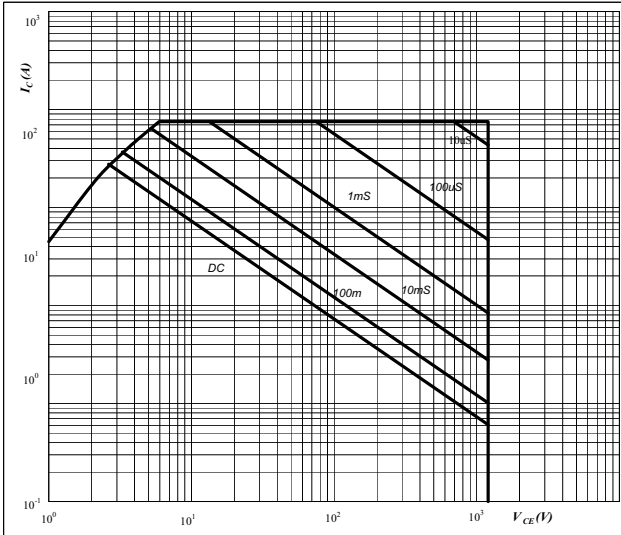

D = single pulse  
 $T_n = 80 \text{ } ^\circ\text{C}$   
 $V_{GE} = \pm 15 \text{ V}$   
 $T_j = T_{jmax} \text{ } ^\circ\text{C}$

**Figure 26** Output inverter IGBT

Gate voltage vs Gate charge

$$V_{GE} = f(Q_g)$$

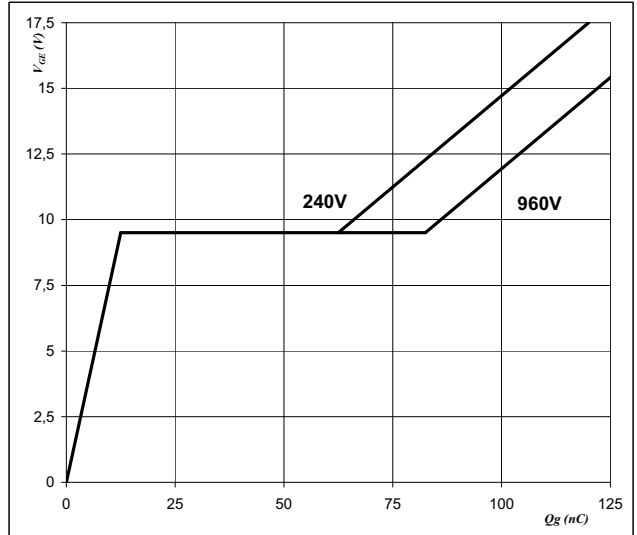

$I_C = 25 \text{ A}$

## Thermistor

**Figure 1** Thermistor

Typical NTC characteristic as a function of temperature  
 $R_T = f(T)$

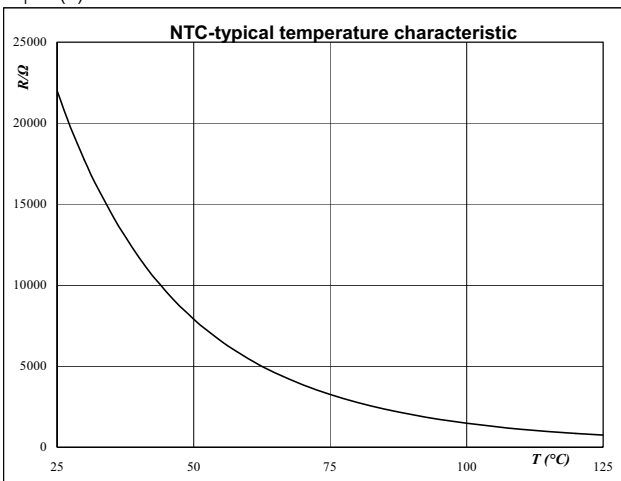

## Switching Definitions Output Inverter

**General conditions**

$T_j$	=	150 °C
$R_{gon}$	=	32 $\Omega$
$R_{goff}$	=	32 $\Omega$

**Figure 1** Output inverter IGBT

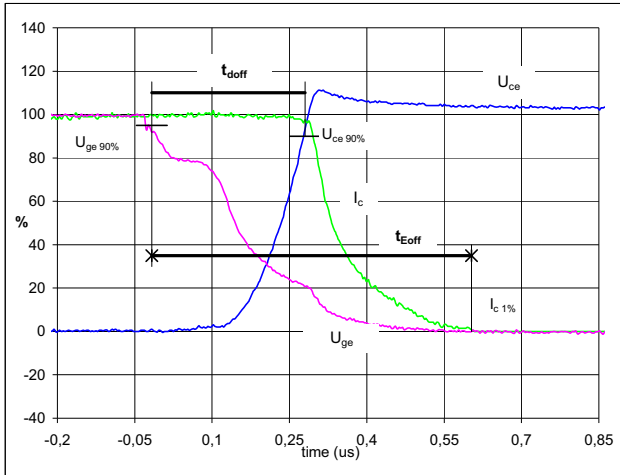
**Turn-off Switching Waveforms & definition of  $t_{doff}$ ,  $t_{Eoff}$**   
 ( $t_{Eoff}$  = integrating time for  $E_{off}$ )

$V_{GE}(0\%)$	=	-15	V
$V_{GE}(100\%)$	=	15	V
$V_C(100\%)$	=	600	V
$I_C(100\%)$	=	25	A
$t_{doff}$	=	0,29	$\mu s$
$t_{Eoff}$	=	0,62	$\mu s$

**Figure 2** Output inverter IGBT

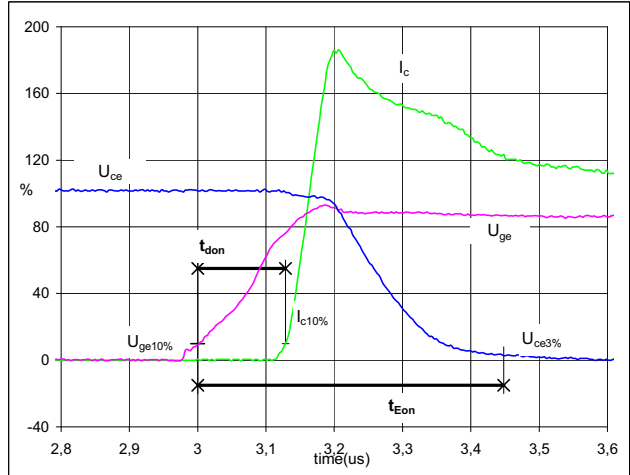
**Turn-on Switching Waveforms & definition of  $t_{don}$ ,  $t_{Eon}$**   
 ( $t_{Eon}$  = integrating time for  $E_{on}$ )

$V_{GE}(0\%)$	=	-15	V
$V_{GE}(100\%)$	=	15	V
$V_C(100\%)$	=	600	V
$I_C(100\%)$	=	25	A
$t_{don}$	=	0,13	$\mu s$
$t_{Eon}$	=	0,45	$\mu s$

**Figure 3** Output inverter IGBT

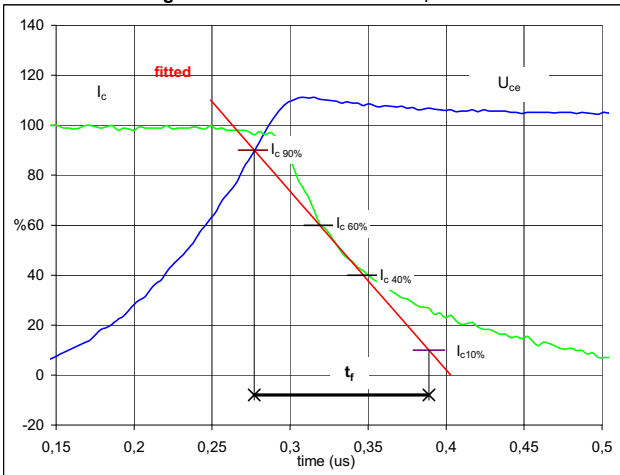
**Turn-off Switching Waveforms & definition of  $t_f$** 

$V_C(100\%)$	=	600	V
$I_C(100\%)$	=	25	A
$t_f$	=	0,12	$\mu s$

**Figure 4** Output inverter IGBT

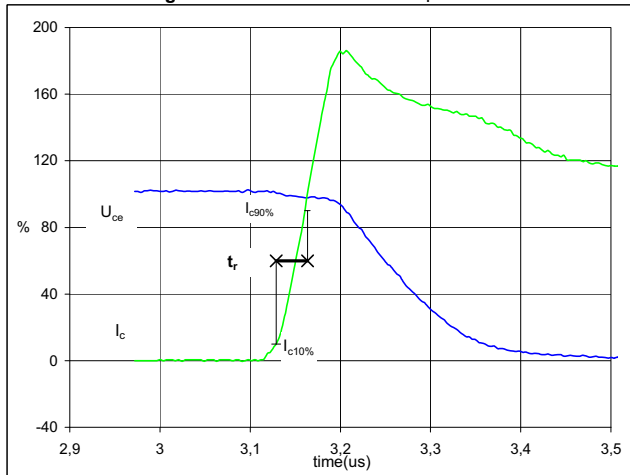
**Turn-on Switching Waveforms & definition of  $t_r$** 

$V_C(100\%)$	=	600	V
$I_C(100\%)$	=	25	A
$t_r$	=	0,03	$\mu s$

## Switching Definitions Output Inverter

**Figure 5** Output inverter IGBT

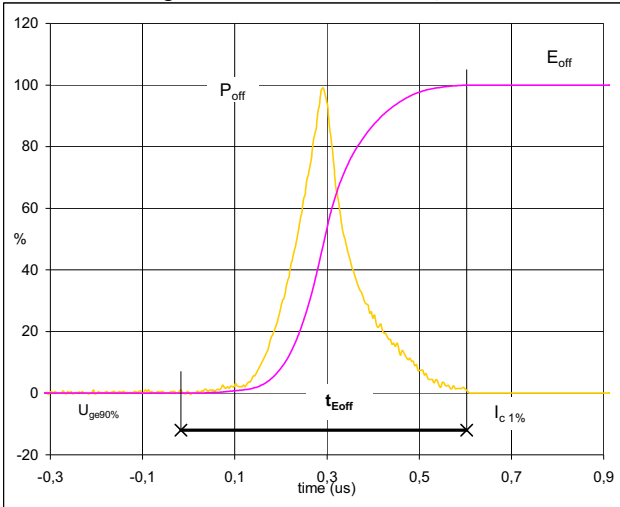
**Turn-off Switching Waveforms & definition of  $t_{Eoff}$** 

$P_{off} (100\%) =$	15,10	kW
$E_{off} (100\%) =$	2,16	mJ
$t_{Eoff} =$	0,62	$\mu$ s

**Figure 6** Output inverter IGBT

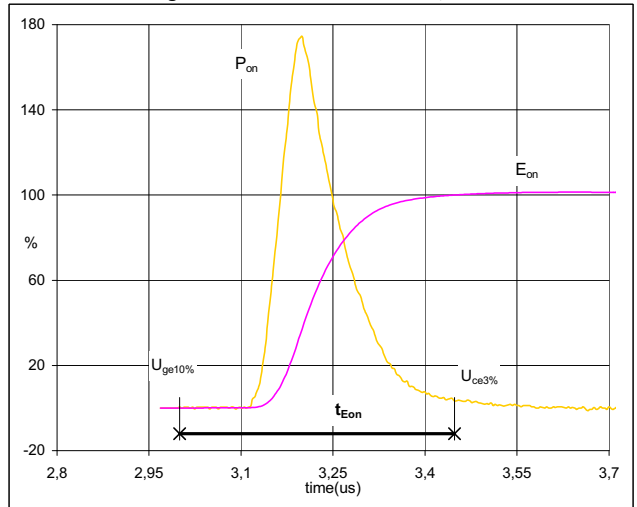
**Turn-on Switching Waveforms & definition of  $t_{Eon}$** 

$P_{on} (100\%) =$	15,10	kW
$E_{on} (100\%) =$	3,00	mJ
$t_{Eon} =$	0,45	$\mu$ s

**Figure 7** Output inverter FRED

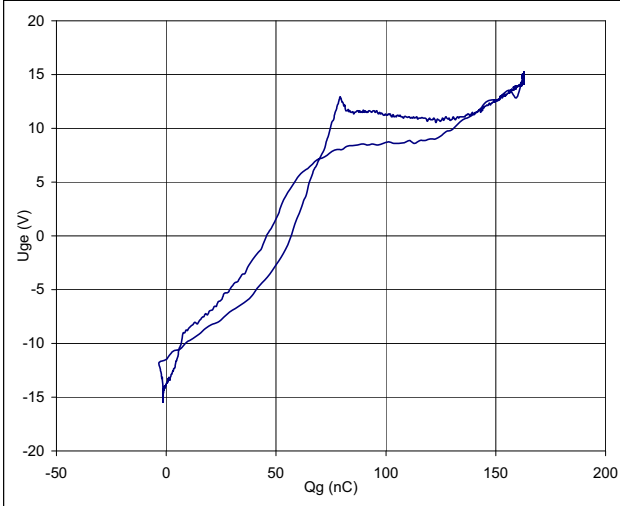
**Gate voltage vs Gate charge (measured)**

$V_{GEoff} =$	-15	V
$V_{GEon} =$	15	V
$V_C (100\%) =$	600	V
$I_C (100\%) =$	25	A
$Q_g =$	678	nC

**Figure 8** Output inverter IGBT

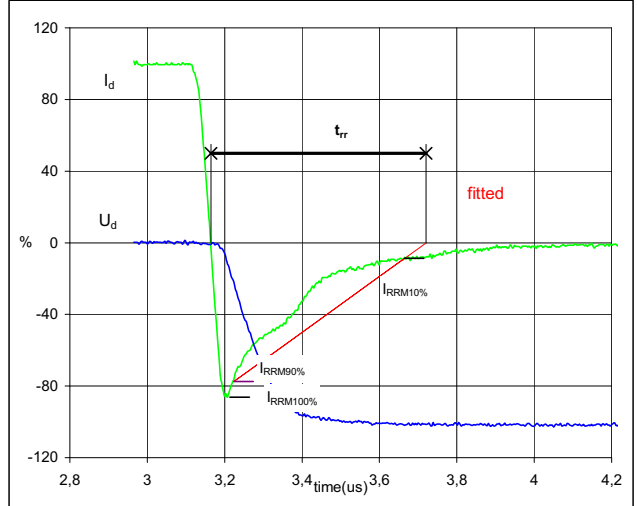
**Turn-off Switching Waveforms & definition of  $t_{rr}$** 

$V_d (100\%) =$	600	V
$I_d (100\%) =$	25	A
$I_{RRM} (100\%) =$	-22	A
$t_{rr} =$	0,59	$\mu$ s

## Switching Definitions Output Inverter

**Figure 9** Output inverter FRED

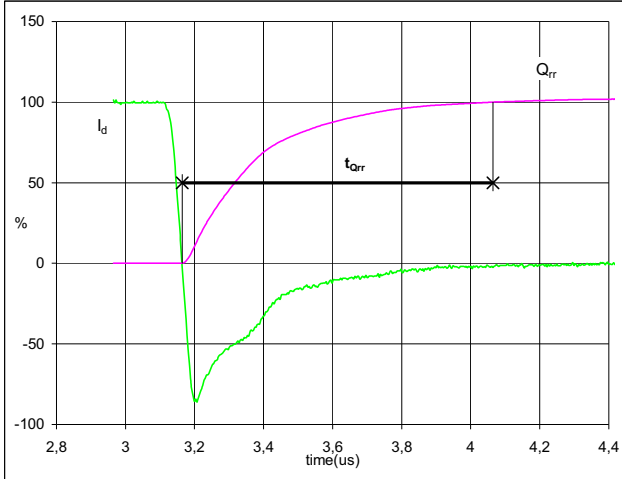
**Turn-on Switching Waveforms & definition of  $t_{Qrr}$**   
 ( $t_{Qrr}$  = integrating time for  $Q_{rr}$ )

$I_d$ (100%) =	25	A
$Q_{rr}$ (100%) =	4,94	$\mu\text{C}$
$t_{Qrr}$ =	0,90	$\mu\text{s}$

**Figure 10** Output inverter FRED

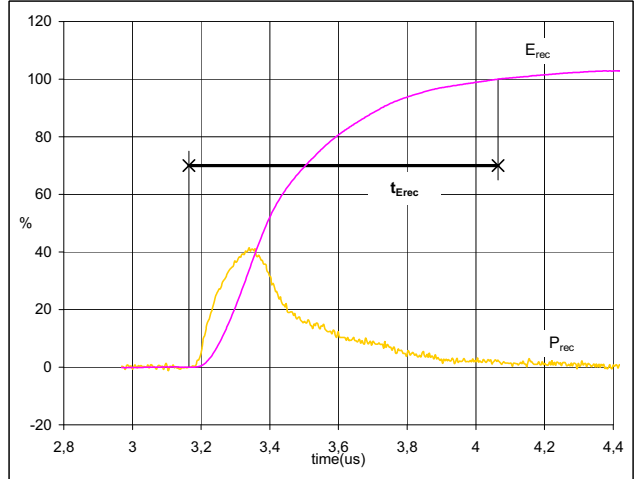
**Turn-on Switching Waveforms & definition of  $t_{Erec}$**   
 ( $t_{Erec}$  = integrating time for  $E_{rec}$ )

$P_{rec}$ (100%) =	15,10	kW
$E_{rec}$ (100%) =	1,97	mJ
$t_{Erec}$ =	0,90	$\mu\text{s}$

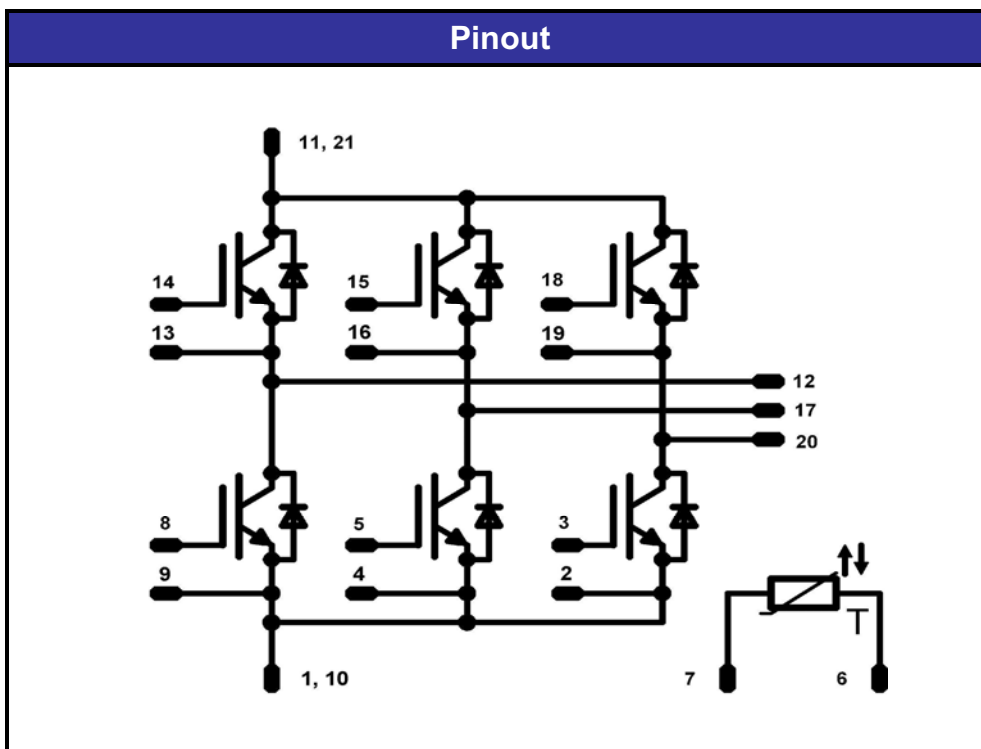
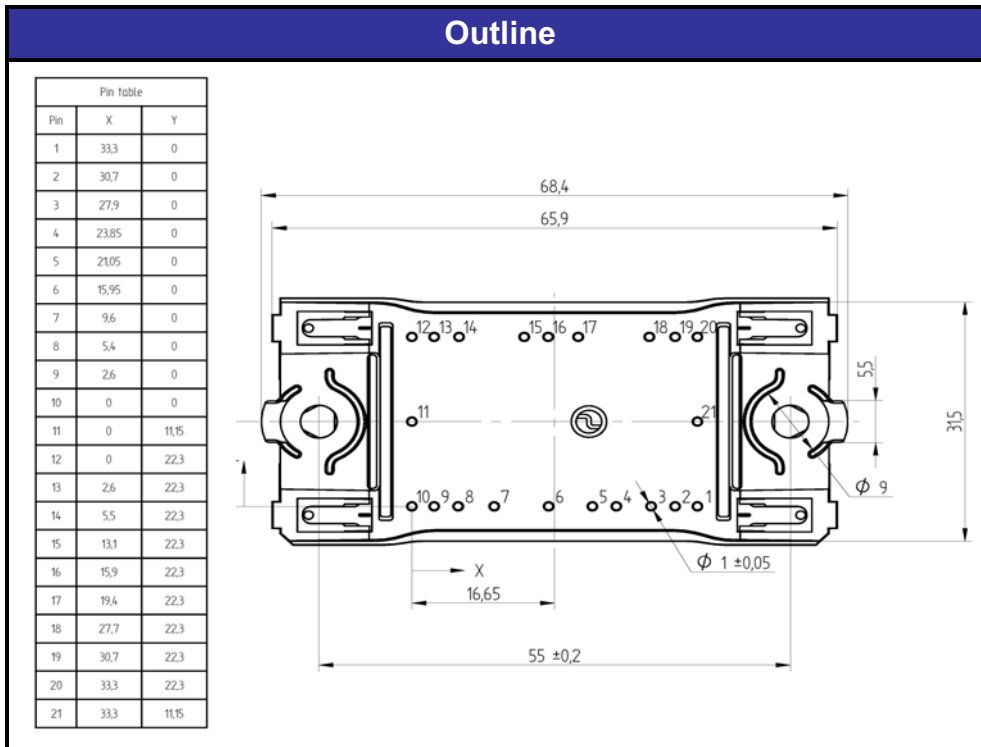
**Package Outline and Pinout**

**PRODUCT STATUS DEFINITIONS**

<b>Datasheet Status</b>	<b>Product Status</b>	<b>Definition</b>
Target	Formative or In Design	This datasheet contains the design specifications for product development. Specifications may change in any manner without notice. The data contained is exclusively intended for technically trained staff.
Preliminary	First Production	This datasheet contains preliminary data, and supplementary data may be published at a later date. Vincotech reserves the right to make changes at any time without notice in order to improve design. The data contained is exclusively intended for technically trained staff.
Final	Full Production	This datasheet contains final specifications. Vincotech reserves the right to make changes at any time without notice in order to improve design. The data contained is exclusively intended for technically trained staff.

**DISCLAIMER**

The information given in this datasheet describes the type of component and does not represent assured characteristics. For tested values please contact Vincotech. Vincotech reserves the right to make changes without further notice to any products herein to improve reliability, function or design. Vincotech does not assume any liability arising out of the application or use of any product or circuit described herein; neither does it convey any license under its patent rights, nor the rights of others.

**LIFE SUPPORT POLICY**

Vincotech products are not authorised for use as critical components in life support devices or systems without the express written approval of Vincotech.

As used herein:

1. Life support devices or systems are devices or systems which, (a) are intended for surgical implant into the body, or (b) support or sustain life, or (c) whose failure to perform when properly used in accordance with instructions for use provided in labelling can be reasonably expected to result in significant injury to the user.
2. A critical component is any component of a life support device or system whose failure to perform can be reasonably expected to cause the failure of the life support device or system, or to affect its safety or effectiveness.