



DESCRIPTION

The A6300A is designed for portable RF and wireless applications with demanding performance and space requirements.

The A6300A performance is optimized for battery-powered systems to deliver ultra low noise and low quiescent current. A noise bypass pin is available for further reduction of output noise. Regulator ground current increases only slightly in dropout, further prolonging the battery life.

The A6300A also works with low- ESR ceramic capacitors, reducing the amount of board space necessary for power applications, critical in hand-held wireless devices.

The A6300A consumes less than 0.01 μ A in shutdown mode and has fast turn-on time less than 50 μ s. The other features include ultra low dropout voltage, high output accuracy, current limiting protection, and high ripple rejection ratio.

The A6300A is available in SOT-23 and SOT-25 packages.

FEATURES

- Ultra-low Noise for RF Application
- Ultra-Fast Response in Line/Load Transient
- Quick Start-Up (Typically 50 μ S)
- <0.01 μ A Standby Current When Shutdown.
- Low Dropout:210mV@300mA
- Wide Operating Voltage Ranges:2V to 6V
- Output Voltage Accuracy: \pm 2%
- TTL-logic-Controlled Shutdown Input
- Low Temperature Coefficient
- Current Limiting Protection
- Thermal Shutdown Protection
- Only 1 μ F Output Capacitor Required for Stability
- High Power Supply Rejection Ratio
- Custom Voltage Available
- Fast output discharge
- Available in SOT-23 and SOT-25 Packages.

ORDERING INFORMATION

Package Type	Part Number	
SOT-23	E3	A6300AE3R-XXA
		A6300AE3VR-XXA
SOT-25	E5	A6300AE5R-XXA
		A6300AE5VR-XXA
Note	XX =Output Voltage 18=1.8V,25=2.5V,33=3.3V V: Halogen free Package R : Tape & Reel	
AiT provides all RoHS products Suffix " V " means Halogen free Package		

APPLICATIONS

- Cellular and Smart Phones
- Battery-Powered Equipment
- Laptop, Palmtops, Notebook Computers
- Hand-Held Instruments
- PCMCIA Cards
- MP3/MP4/MP5 Players
- Portable Information Appliances

TYPICAL APPLICATION

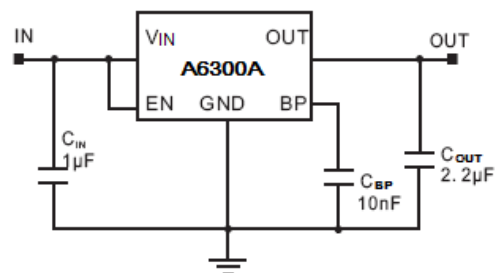



PIN DESCRIPTION

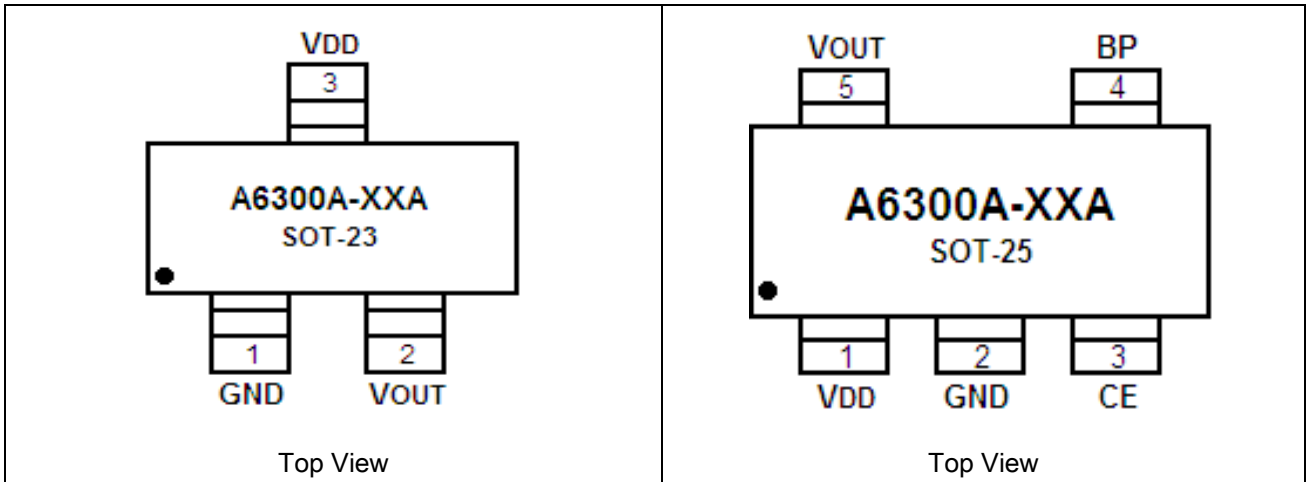

Pin #		Symbol	Function
SOT-23	SOT-25		
3	1	V_{IN}	Power Input Voltage.
1	2	GND	Ground.
-	3	CE	Chip Enable Pin with four options
-	4	BP	Reference Noise Bypass. FB pin for adjustable version
2	5	V_{OUT}	Output Voltage.



ABSOLUTE MAXIMUM RATINGS

V _{CC} , Input Supply Voltage	-0.3V to +6V
CE Input Voltage	-0.3V to +V _{IN}
Output Voltage	-0.3V to V _{IN} +0.3V
BP Voltage	-0.3V to +6V
Output Current	300mA
Maximum Junction Temperature	125°C
Operating Temperature Range ^{NOTE1}	-40°C to 85°C
Storage Temperature Range	-65°C to 125°C
ESD	2KV
Lead Temperature (Soldering, 10s)	300°C

Stresses above may cause permanent damage to the device. These are stress ratings only and functional operation of the device at these or any other conditions beyond those indicated in the Electrical Characteristics are not implied. Exposure to absolute maximum rating conditions for extended periods may affect device reliability.

NOTE1: The A6300A is guaranteed to meet performance specifications from 0°C to 70°C. Specifications over the -40°C to 85°C operating temperature range are assured by design, characterization and correlation with statistical process controls.

THERMAL RESISTANCE

Package	θ_{JA}	θ_{JC}
SOT-23	250°C/W	130°C/W
SOT-25	250°C/W	130°C/W

NOTE: Thermal Resistance is specified with approximately 1 square of 1 oz copper.



ELECTRICAL CHARACTERISTICS

V_{DD}=3.6V, CE=V_{DD}, C_{IN}=C_{OUT}=1μF, C_{BP}=22nF, T_A=25°C, unless otherwise specified.

Parameter	Symbol	Conditions	Min	Typ.	Max	Units	
Input Voltage	V _{DD}	-	1.8	-	6	V	
Output Voltage Accuracy	ΔV _{OUT}	V _{IN} =3.6V, I _{OUT} =1mA	-2	-	+2	%	
Current Limit	I _{LIM}	R _{LOAD} =1Ω	400	430	-	mA	
Quiescent Current	I _Q	V _{CE} >1.2V, I _{OUT} =0mA	-	90	130	μA	
Dropout Voltage	V _{DROP}	I _{OUT} =200mA, V _{OUT} =2.8V	-	130	180	mV	
		I _{OUT} =300mA, V _{OUT} =2.8V	-	210	300		
Line Regulation ^{Note2}	ΔV _{LINE}	V _{IN} =3.6V to 5.5V I _{OUT} =1mA	-	0.05	0.17	%/V	
Load Regulation ^{Note3}	ΔV _{LOAD}	1mA<I _{OUT} <300mA	-	-	2	%/A	
Output Voltage Temperature Coefficient ^{Note4}	TC _{VOUT}	I _{OUT} =1mA	-	±60	-	ppm/°C	
Standby Current	I _{STBY}	V _{CE} =GND, Shutdown	-	0.01	1	μA	
CE Input Bias Current	I _{IBSD}	V _{EN} =GND or V _{IN}	-	0	100	nA	
CE 0.4 V Input Threshold	Logic Low	V _{IL}	V _{IN} =3V to 5.5V, Shutdown	-	-	0.4	V
	Logic High	V _{IH}	V _{IN} =3V to 5.5V, Start up	1.2	-	-	V
Output Noise Voltage	e _{NO}	10Hz to 100KHz, I _{OUT} =200mA, C _{OUT} =1μF	-	100	-	μV _{RMS}	
Power Supply Rejection Ratio	f=217Hz	PSRR	C _{OUT} =1μF, I _{OUT} =100mA	-	-80	-	dB
	f=1KHz			-	-78	-	
	f=10KHz			-	-65	-	
Thermal Shutdown Temperature	T _{SD}	Shutdown, Temp increasing	-	165	-	°C	
Thermal Shutdown Hysteresis	T _{SDHY}	-	-	30	-	°C	

NOTE2: Line regulation is calculated by

$$\Delta V_{LINE} = \left(\frac{V_{OUT1} - V_{OUT2}}{\Delta V_{IN} \times V_{OUT(Normal)}} \right) \times 100$$

Where V_{OUT1} is the output voltage when V_{IN}=5.5V, and V_{OUT2} is the output voltage when V_{IN}=3.6V, ΔV_{IN}=1.9V. V_{OUT(normal)}=2.8V.

NOTE3: Load regulation is calculated by

$$\Delta V_{LOAD} = \left(\frac{V_{OUT1} - V_{OUT2}}{\Delta I_{OUT} \times V_{OUT(Normal)}} \right) \times 100$$

Where V_{OUT1} is the output voltage when I_{OUT}=1mA, and V_{OUT2} is the output voltage when I_{OUT}=300mA. ΔI_{OUT}=0.299A, V_{OUT(normal)}=2.8V.

NOTE4: The temperature coefficient is calculated by

$$TC_{VOUT} = \frac{V_{OUT}}{\Delta T \times V_{OUT}}$$



TYPICAL PERFORMANCE CHARACTERISTICS

1. Output Voltage vs. Temperature

$V_{IN}=3.6V$, $C_{IN}=C_{OUT}=1\mu F$

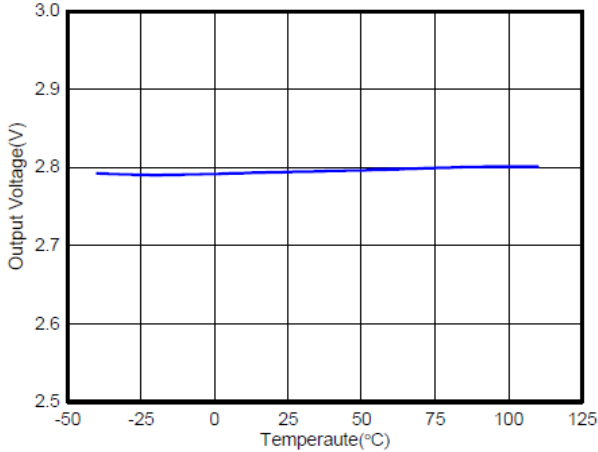

2. Quiescent Current vs. Temperature

$V_{IN}=3.6V$, $C_{IN}=C_{OUT}=1\mu F$

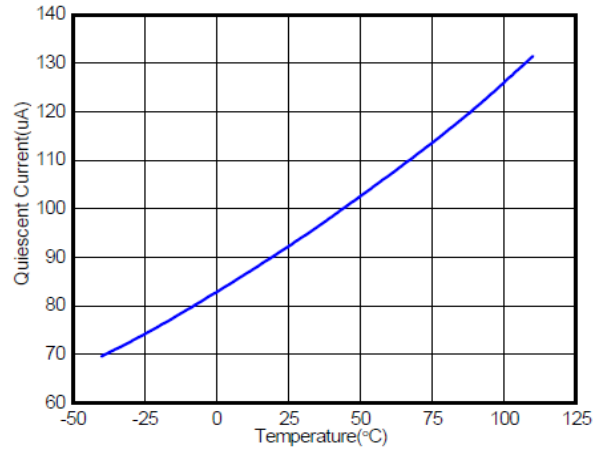

3. Dropout Voltage vs. Load Current

$C_{IN}=C_{OUT}=1\mu F$

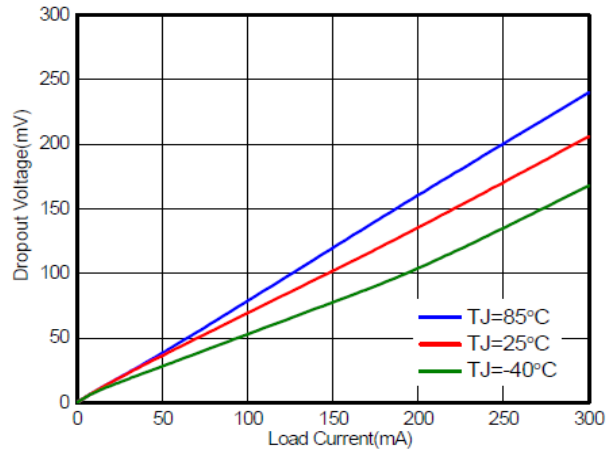

4. PSRR

$V_{IN}=3.6V$, $C_{BP}=22nF$, $C_{IN}=C_{OUT}=1\mu F$

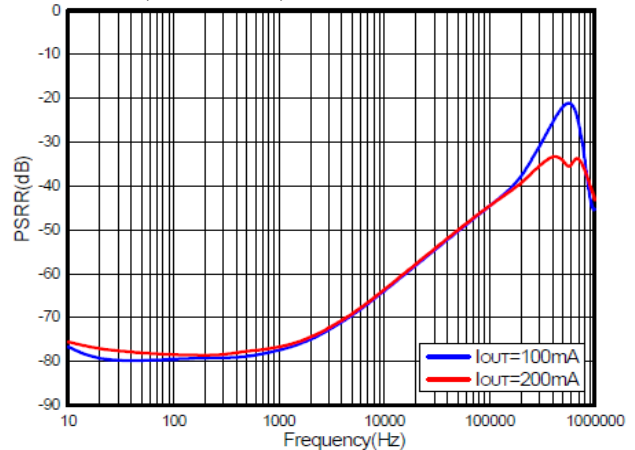

5. CE Pin Shutdown Threshold vs. Temperature

$V_{IN}=3.6V$, $C_{IN}=C_{OUT}=1\mu F$

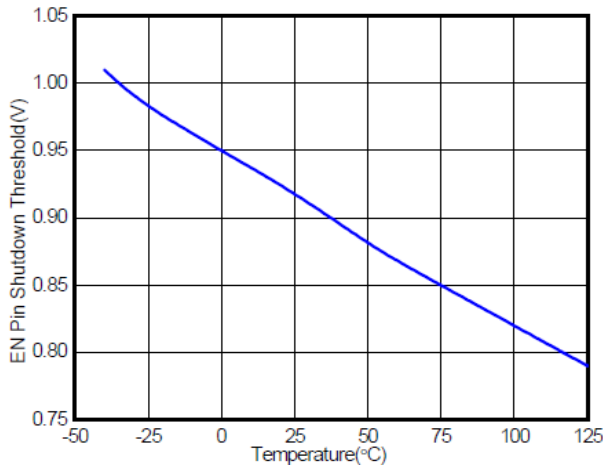

6. CE Pin Shutdown Response

$V_{IN}=5V$, $C_{IN}=C_{OUT}=1\mu F$, No Load

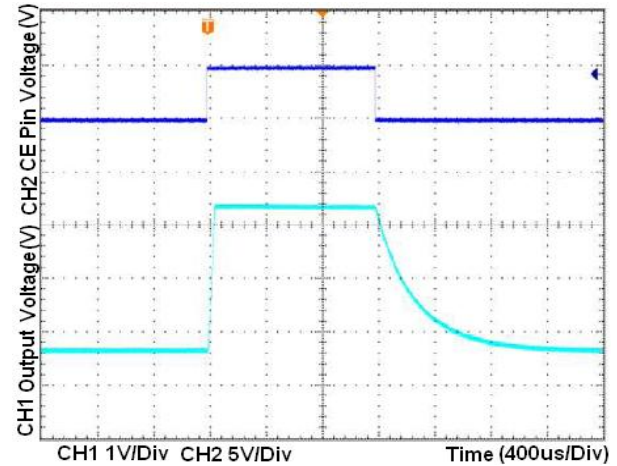



7. Load Transient Response

$V_{IN}=5V, V_{OUT}=2.8V, C_{IN}=C_{OUT}=1\mu F, I_{LOAD}=1$ to $60mA$

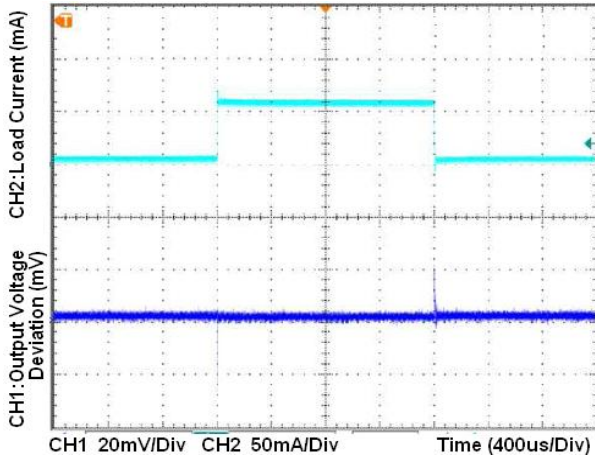

8. Load Transient Response

$V_{IN}=5V, V_{OUT}=2.8V, C_{IN}=C_{OUT}=1\mu F, I_{LOAD}=1$ to $250mA$

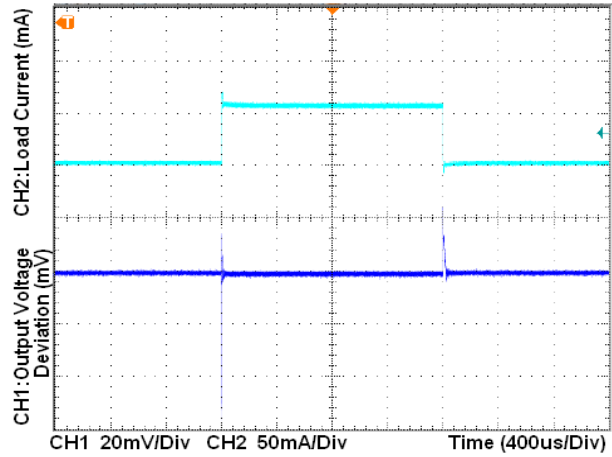

9. Line Transient Response

$V_{IN}=4$ to $5V, C_{IN}=C_{OUT}=1\mu F, I_{LOAD}=1mA$

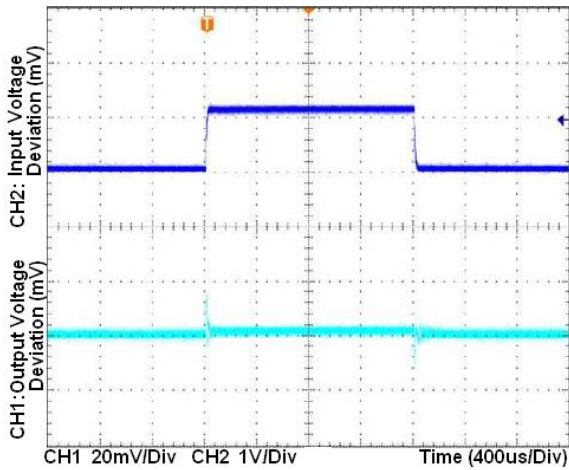

10. Line Transient Response

$V_{IN}=4$ to $5V, C_{IN}=C_{OUT}=1\mu F, I_{LOAD}=100mA$

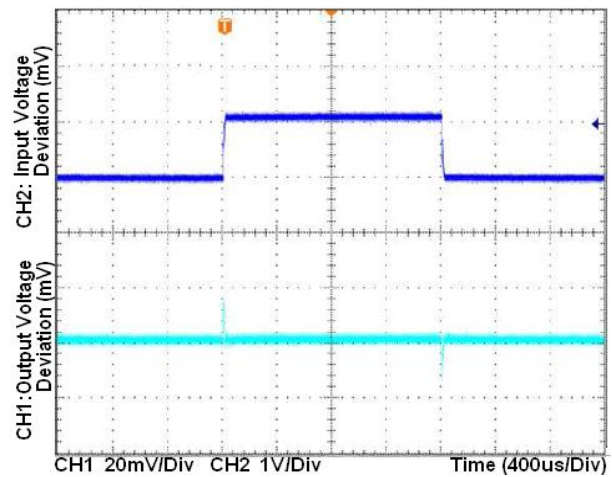

11. Start Up

$V_{IN}=5V, C_{IN}=C_{OUT}=1\mu F, \text{No Load}$

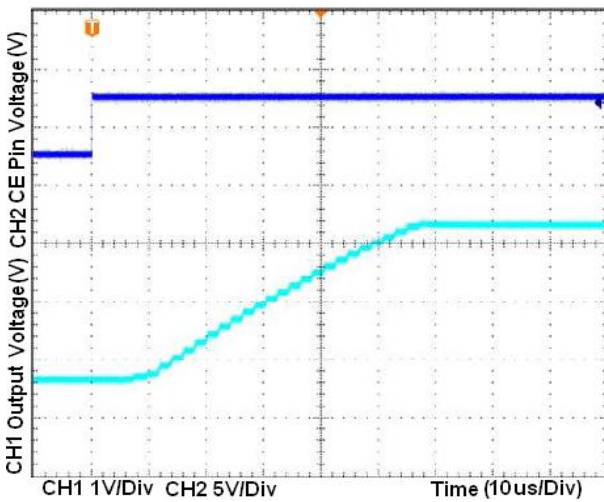



BLOCK DIAGRAM

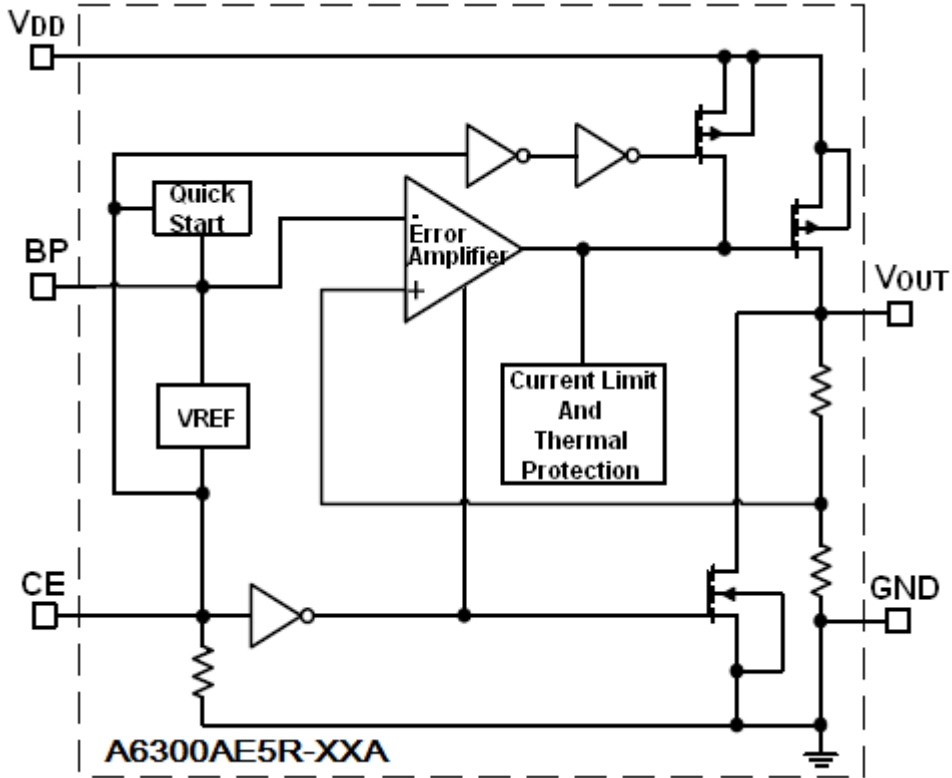



DETAILED INFORMATION

Like any low-dropout regulator, the external capacitors used with the A6300A must be carefully selected for regulator stability and performance. Using a capacitor whose value is $> 1\mu\text{F}$ on the A6300A input and the amount of capacitance can be increased without limit. The input capacitor must be located a distance of not more than 0.5 inch from the input pin of the IC and returned to a clean analog ground. Any good quality ceramic or tantalum can be used for this capacitor. The capacitor with larger value and lower ESR (equivalent series resistance) provides better PSRR and line-transient response. The output capacitor must meet both requirements for minimum amount of capacitance and ESR in all LDOs application.

The A6300A is designed specifically to work with low ESR ceramic output capacitor in space-saving and performance consideration. Using a ceramic capacitor whose value is at least $1\mu\text{F}$ with ESR is $> 25\text{m}\Omega$ on the A6300A output ensures stability. The A6300A still works well with output capacitor of other types due to the wide stable ESR range. Output capacitor of larger capacitance can reduce noise and improve load transient response, stability, and PSRR. The output capacitor should be located not more than 0.5 inch from the V_{OUT} pin of the A6300A and returned to a clean analog ground.

Bypass Capacitor and Low Noise

Connecting a 22nF between the BP pin and GND pin significantly reduces noise on the regulator output, it is critical that the capacitor connection between the BP pin and GND pin be direct and PCB traces should be as short as possible. There is a relationship between the bypass capacitor value and the LDO regulator turn on time. DC leakage on this pin can affect the LDO regulator output noise and voltage regulation performance.

Enable Function

The A6300A features an LDO regulator enable/ disable function. To assure the LDO regulator will switch on; the CE turn on control level must be greater than 1.2 volts. The LDO regulator will go into the shutdown mode when the voltage on the CE pin falls below 0.4 volts. For to protect the system, the A6300A have a quick discharge function. If the enable function is not needed in a specific application, it may be tied to V_{DD} to keep the LDO regulator in a continuously on state.

Thermal Considerations

Thermal protection limits power dissipation in A6300A. When the operation junction temperature exceeds 165°C , the OTP circuit starts the thermal shutdown function turn the pass element off. The pass element turns on again after the junction temperature cools by 30°C . For continue operation, do not exceed absolute maximum operation junction temperature 125°C . The power dissipation definition in device is:

$$P_D = (V_{\text{IN}} - V_{\text{OUT}}) \times I_{\text{OUT}} + V_{\text{IN}} \times I_Q$$

The maximum power dissipation depends on the thermal resistance of IC package, PCB layout, the rate of surroundings airflow and temperature difference between junctions to ambient. The maximum power dissipation can be calculated by following formula :

$$P_D (\text{MAX}) = (T_J (\text{MAX}) - T_A) / \theta_{\text{JA}}$$



Where $T_J(\text{MAX})$ is the maximum operation junction temperature 125°C , T_A is the ambient temperature and the θ_{JA} is the junction to ambient thermal resistance. For recommended operating conditions specification of A6300A, where $T_J(\text{MAX})$ is the maximum junction temperature of the die (125°C) and T_A is the maximum ambient temperature. The junction to ambient thermal resistance (θ_{JA} is layout dependent) for SOT-23 AND SOT-25 package are $250^\circ\text{C}/\text{W}$, on standard JEDEC 51-3 thermal test board. The maximum power dissipation at $T_A = 25^\circ\text{C}$ can be calculated by following formula:

$$P_D(\text{MAX}) = (125^\circ\text{C} - 25^\circ\text{C}) / 250 = 400\text{mW} \text{ (SOT-23 \& SOT-25)}$$

The maximum power dissipation depends on operating ambient temperature for fixed $T_J(\text{MAX})$ and thermal resistance θ_{JA} . It is also useful to calculate the junction of temperature of the A6300A under a set of specific conditions. In this example let the Input voltage $V_{IN} = 3.3\text{V}$, the output current $I_O = 300\text{mA}$ and the case temperature $T_A = 40^\circ\text{C}$ measured by a thermal couple during operation. The power dissipation for the $V_O = 2.8\text{V}$ version of the A6300A can be calculated as:

$$P_D = (3.3\text{V} - 2.8\text{V}) \times 300\text{mA} + 3.6\text{V} \times 100\mu\text{A} = 150\text{mW}$$

And the junction temperature, T_J , can be calculated as follows:

$$T_J = T_A + P_D \times \theta_{JA} = 40^\circ\text{C} + 0.15\text{W} \times 250^\circ\text{C}/\text{W} = 40^\circ\text{C} + 37.5^\circ\text{C} = 77.5^\circ\text{C} < T_J(\text{MAX}) = 125^\circ\text{C}$$

For this operating condition, T_J is lower than the absolute maximum operating junction temperature, 125°C , so it is safe to use the A6300A in this configuration.

Layout considerations

To improve ac performance such as PSRR, output noise, and transient response, it is recommended that the PCB be designed with separate ground planes for V_{IN} and V_{OUT} , with each ground plane connected only at the GND pin of the device. In addition, the ground connection for the bypass capacitor should connect directly to the GND pin of the A6300A.



PACKAGE INFORMATION

Dimension in SOT-23 Package (Unit: mm)

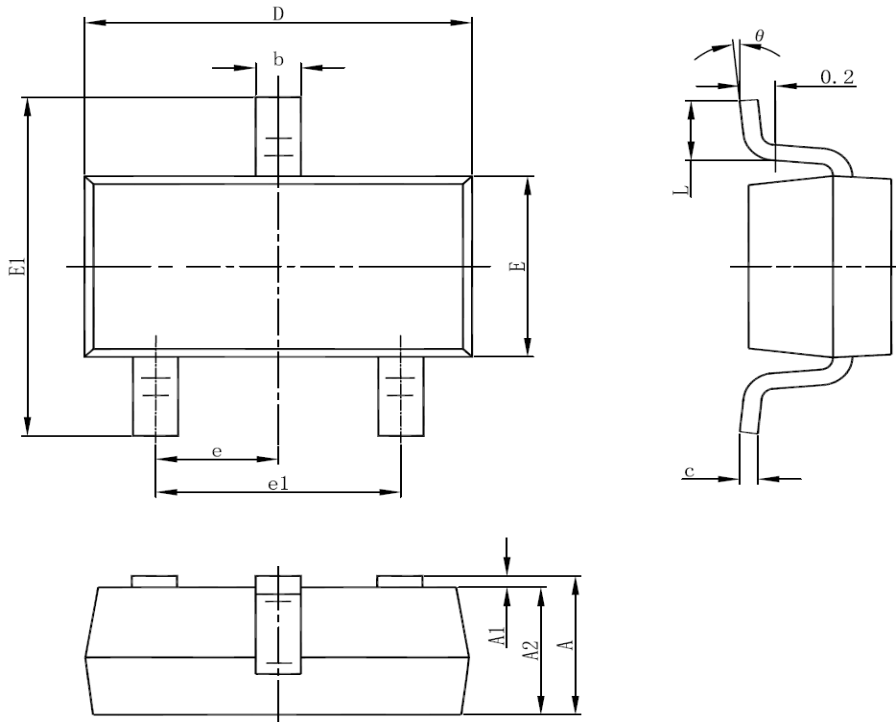

SYMBOL	MIN	MAX
A	1.050	1.250
A1	0.000	0.100
A2	1.050	1.150
b	0.300	0.500
c	0.100	0.200
D	2.820	3.020
E	1.500	1.700
E1	2.650	2.950
e	0.950(BSC)	
e1	1.800	2.000
L	0.300	0.600
θ	0°	8°



Dimension in SOT-25 (Unit: mm)

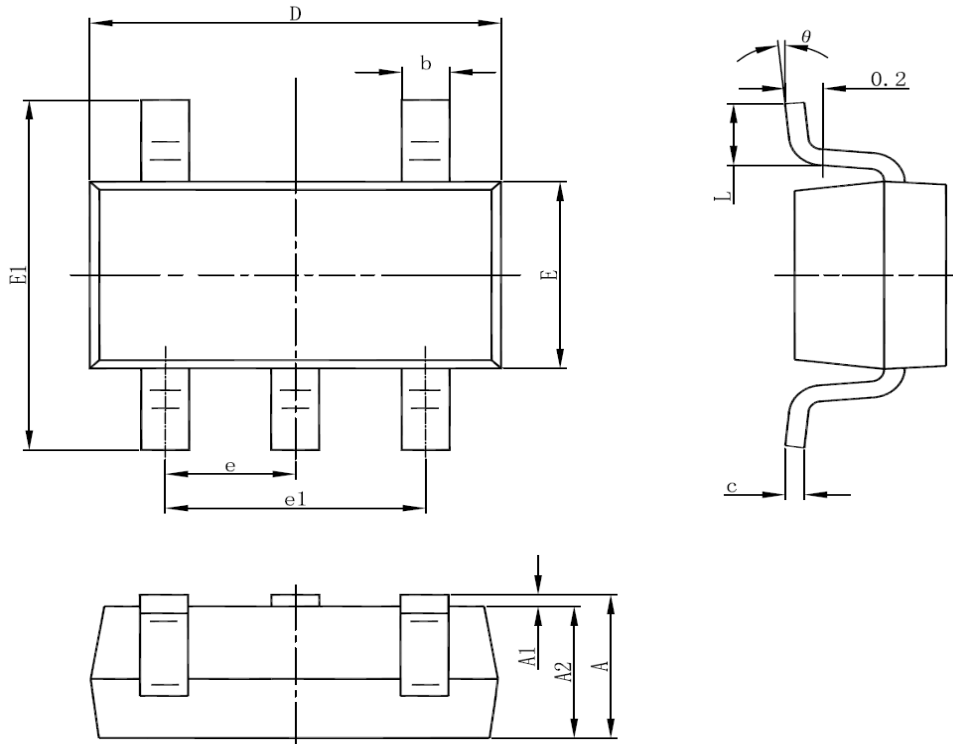

Symbol	Min	Max
A	1.050	1.250
A1	0.000	0.100
A2	1.050	1.150
b	0.300	0.500
c	0.100	0.200
D	2.820	3.020
E	1.500	1.700
E1	2.650	2.950
e	0.950(BSC)	
e1	1.800	2.000
L	0.300	0.600
θ	0°	8°



IMPORTANT NOTICE

AiT Semiconductor Inc. (AiT) reserves the right to make changes to any its product, specifications, to discontinue any integrated circuit product or service without notice, and advises its customers to obtain the latest version of relevant information to verify, before placing orders, that the information being relied on is current.

AiT Semiconductor Inc.'s integrated circuit products are not designed, intended, authorized, or warranted to be suitable for use in life support applications, devices or systems or other critical applications. Use of AiT products in such applications is understood to be fully at the risk of the customer. As used herein may involve potential risks of death, personal injury, or severe property, or environmental damage. In order to minimize risks associated with the customer's applications, the customer should provide adequate design and operating safeguards.

AiT Semiconductor Inc. assumes to no liability to customer product design or application support. AiT warrants the performance of its products of the specifications applicable at the time of sale.