

306/316/356 SERIES



Card Edge Connector 0.156" (3.96mm) Pitch

Features:

- 0.156" (3.96mm) contact spacing with single centreline row
- Accepts 0.062" (1.57mm) nominal thickness P.C. board
- Low profile insulator body, 0.460" (11.68mm)
- Contact termination options include P.C. tail & wire hole
- Large variety of mounting options
- Accepts between contact and in-contact polarizing keys
- Pre-assembled card guides are available
- RoHS Compliant & UL Certified

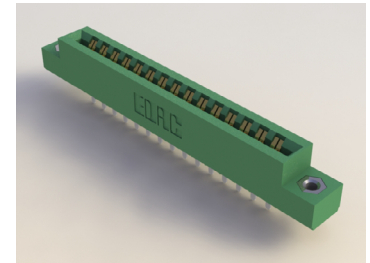

Specifications:

Insulator Material	UL 94V-0 Thermoplastic Polyester
Contact Material	Copper Alloy
Contact Plating	Gold Plating on mating area and Tin Plating on tails with Nickel underplating all over
Current Rating	5 amps
Contact Resistance	10 milliohms maximum
Dielectric Withstanding Voltage	1800 V AC rms at sea level between adjacent contacts
Insulation Resistance	5000 megaohms minimum
Operating Temperature	-40°C to +105°C
Insertion Force	16 oz (4.45 N) maximum per contact pair when tested with .070" (1.78mm) thick gauge
Withdrawal Force	1 oz (0.28 N) minimum per contact pair when tested with .054" (1.37mm) thick gauge

Example Part Number: **306-022-521-178**

Series _____

Total Number of Contacts _____

Contact Code _____

Mounting Options _____

Series:	Insulator Color:	Card Slot Length:	
306	Green	Standard Length per MIL-C-21097	
316	Green	.020" (0.51mm) Shorter than Standard	
356	Black	Standard Length per MIL-C-21097	
Total Number of Contacts:	Contact Rows:		
006, 007, . . . 043	Centre Row		
Contact Code:	Description:	Tail Size:	Tail Length "G":
500	Wire Hole	.087 x .015 (2.21 x 0.38)	.282 (7.16)
520	P.C. Tail	.046 x .015 (1.17 x 0.38)	.213 (5.41)
521	P.C. Tail	.037 x .015 (0.94 x 0.38)	.125 (3.18)
Mounting Options:	Description:		
101	No Mounting Lug		
102	Ø.128" (Ø3.25mm) Mounting Holes		
103	Ø.116" (Ø2.95mm) I.D. Floating Eyelets		
104	Ø.156" (Ø3.96mm) Mounting Holes		
107	M3-0.5 Metric Threaded Inserts		
108	#4-40 Unified Threaded Inserts		
112	Ø.128" (Ø3.25mm) Side Mounting Holes		
158	.468" (11.89mm) Offset Card Guides		
168	.344 (8.74) Offset Card Guides		
178	In-Line Card Guides		

IN-CONTACT
POLARIZING KEY
P/N 338-240-328

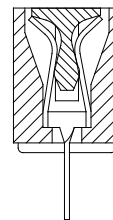

BETWEEN CONTACT
POLARIZING KEY
P/N 306-240-318

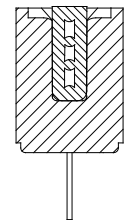

- Ordering Code Notes:**
- 1) All connector sizes up to 43 contacts dual row are available upon request.
 - 2) For contacts with overall tin plating, change the first digit of the contact code from 5 to 4.
 - 3) For details of the mounting options refer to next pages.

306/316/356 SERIES



Card Edge Connector 0.156" (3.96mm) Pitch

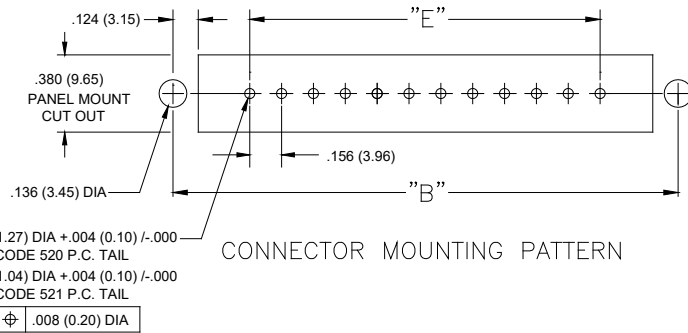
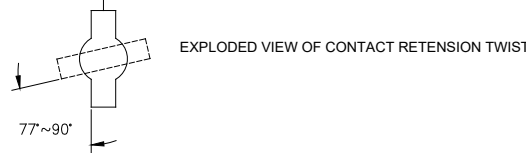
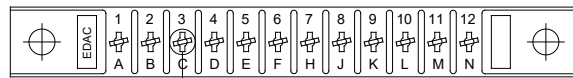
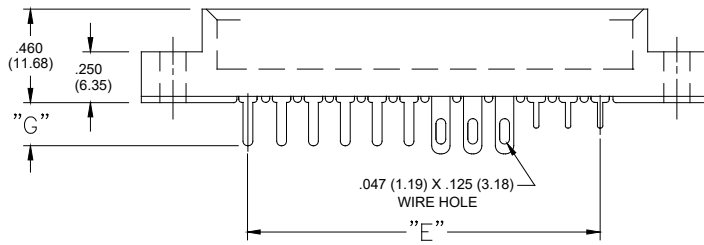
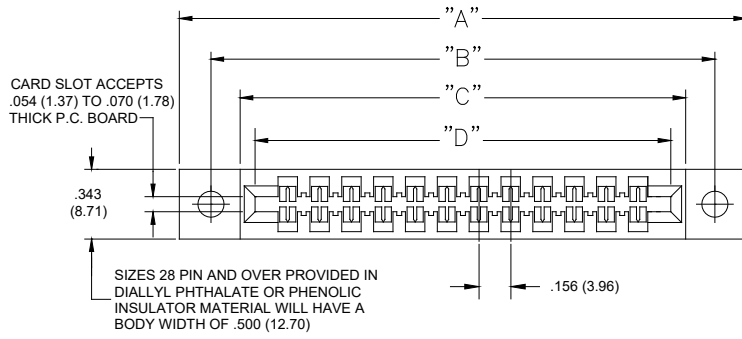

SECTION THROUGH CONTACT POSITION

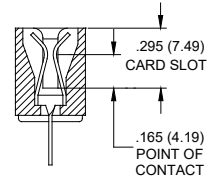

IN-CONTACT POLARIZING KEY

P/N 338-240-328

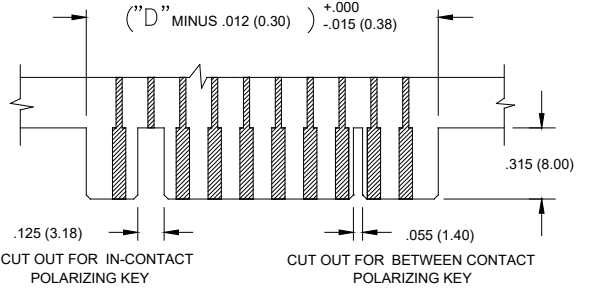
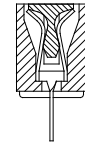

RECOMMENDED DAUGHTER BOARD

NUMBER OF CONTACTS	"A"		"B"		"C"		"D"				"E"	
	inch	mm	inch	mm	inch	mm	306,356		316		inch	mm
6	1.842	46.79	1.532	38.91	1.246	31.65	1.100	27.94	1.080	27.43	0.780	19.81
8	2.154	54.71	1.844	46.84	1.558	39.57	1.412	35.86	1.392	35.36	1.092	27.74
10	2.466	62.64	2.156	54.76	1.87	47.50	1.724	43.79	1.704	43.28	1.404	35.66
12	2.778	70.56	2.468	62.69	2.182	55.42	2.036	51.71	2.016	51.21	1.716	43.59
15	3.246	82.45	2.936	74.57	2.65	67.31	2.504	63.60	2.484	63.09	2.184	55.47
18	3.714	94.34	3.404	86.46	3.118	79.20	2.972	75.49	2.952	74.98	2.652	67.36
22	4.338	110.19	4.028	102.31	3.742	95.05	3.596	91.34	3.576	90.83	3.276	83.21
25	4.806	122.07	4.496	114.20	4.21	106.93	4.064	103.23	4.044	102.72	3.744	95.10
28	5.274	133.96	4.964	126.09	4.678	118.82	4.532	115.11	4.512	114.60	4.212	106.98
30	5.586	141.88	5.276	134.01	4.99	126.75	4.844	123.04	4.824	122.53	4.524	114.91
36	6.522	165.66	6.212	157.78	5.926	150.52	5.780	146.81	5.760	146.30	5.460	138.68
40	7.146	181.51	6.836	173.63	6.55	166.37	6.404	162.66	6.384	162.15	6.084	154.53
43	7.614	193.40	7.304	185.52	7.018	178.26	6.872	174.55	6.852	174.04	6.552	166.42

Card Edge Connector 0.156" (3.96mm) Pitch

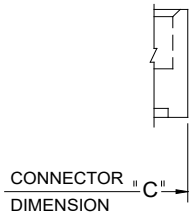

MOUNTING OPTION
CODE x101
(NO MOUNTING LUGS)

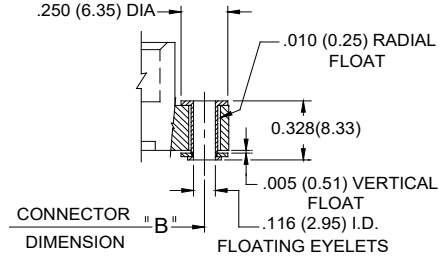

MOUNTING OPTION
CODE x103
(FLOATING EYELETS)

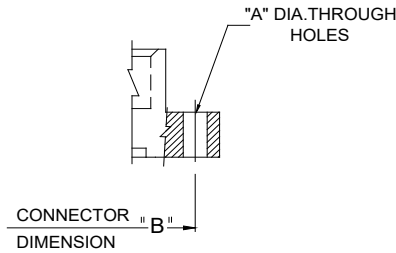

MOUNTING OPTION
CODES x102 AND x104
(THROUGH MOUNTING HOLES)

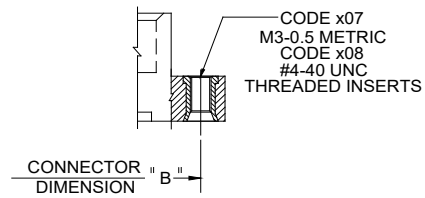

MOUNTING OPTION
CODES x107 & x108
(THREADED INSERTS)

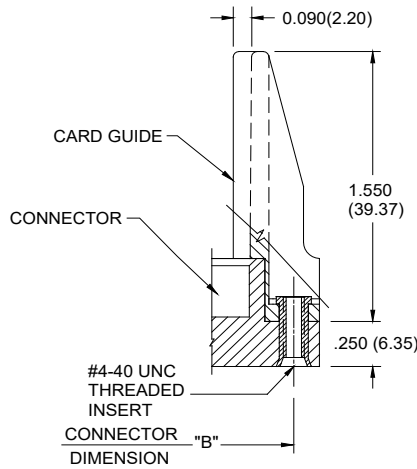

MOUNTING OPTION
CODE x178
(IN-LINE CARD GUIDE)

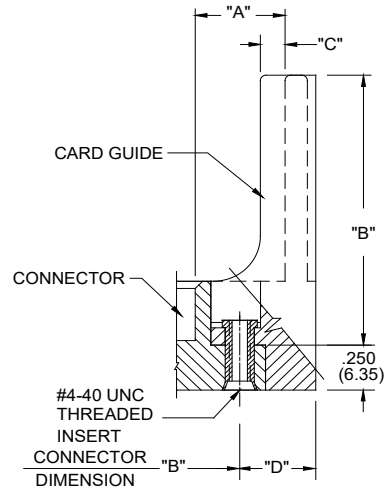

MOUNTING OPTION
CODES x158 & x168
(OFFSET CARD GUIDES)

CODE X102 AND X104- THROUGH MTG. HOLES		CODES X158 AND X168 OFFSET CARD GUIDES		
	CODE X102	CODE X104	CODE X158	CODE X168
"A" DIA.	0.128(3.25)	0.156(3.96)	"A" 0.468(11.89)	0.344(8.74)
CODE X107 AND X108- THREADED INSERTS		"B"	2.755(69.98)	2.505(63.63)
	CODE X107	CODE X108	"C" 0.125(3.18)	0.060(1.52)
INSERT	M3-0.5(METRIC)	#4-40 UNC	"D" 0.423(10.74)	0.242(6.15)