

Digital Oscilloscope Series
Now with a power monitor function!

MEMORY HiCORDER 8855

Digital Oscilloscope 

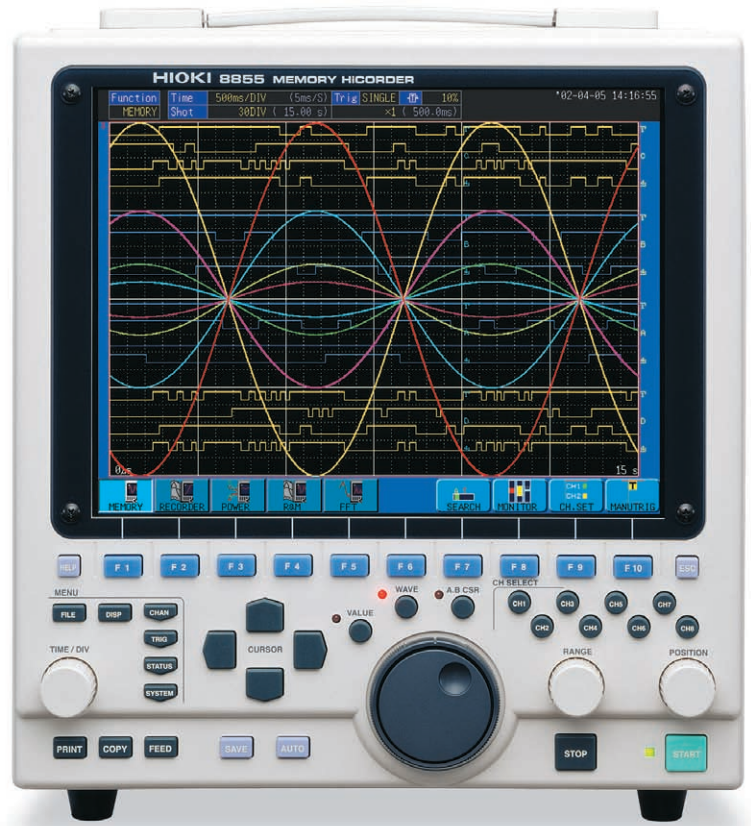

For analyzing power control system operation, digital circuits, and transient power

Extended memory! An oscilloscope with 8 isolated channels

High-speed sampling and expanded memory are essential for simultaneously observing switching carrier waveforms and basic waveforms. Furthermore, greater memory has been requested by users to allow measurement of sporadic and unpredictable events and signals that cannot be triggered. The 20 MS/s high-speed sampling and a memory capacity of up to **512 megawords** (1 GB, optional) of the **MEMORY HiCORDER 8855** makes it the best-equipped isolated digital oscilloscope on the market, and the ideal instrument to search for and analyze anomalous waveforms.



ISO 9001
JMI-0216



ISO 14001
JQA-E-90091



<http://www.hioki.co.jp/>

HIOKI company overview, new products, environmental considerations and other information are available on our website.

For operation analysis of power control systems such as inverters

- Application Examples -

Inverter switching waveforms

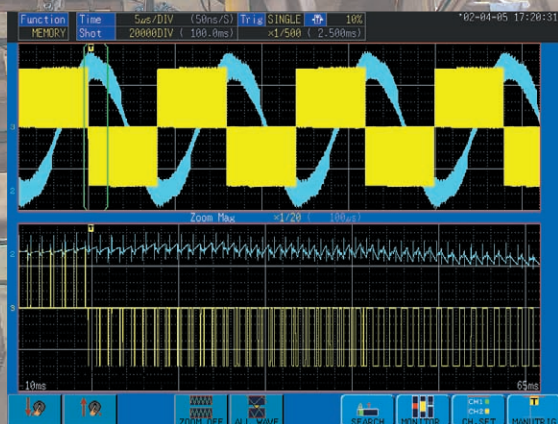

The 8855 can be used to observe various inverter waveforms. To provide stable measurement of voltage waveforms, the 8855 uses high-frequency, noise-resistant CMRR and maintains high floating voltages with isolated inputs. When observing current waveforms, you can install a special amplifier unit for current measurement that allows you to use a supersensitive, broadband clamp-on probe to perform measurements without breaking the electric circuit.

Automobile research and development

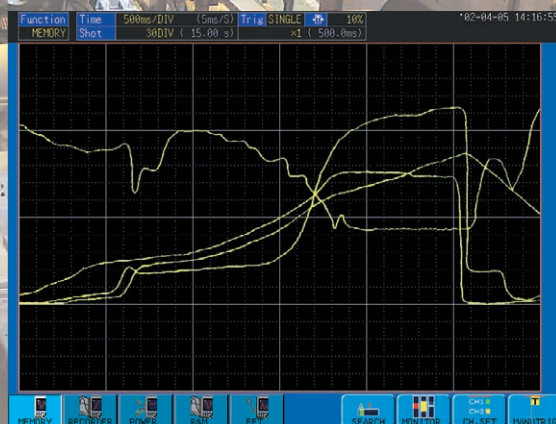

When performing engine characterization analysis, the 8855 is ideally-suited to measuring waveforms derived from boost pressure, oil pressure, air-fuel ratio, ignition timing, rotation speed, or injector opening. The 8855 also has an expanded memory for storing large quantities of data taken in various conditions. The 8855 can be used to observe pressure waveforms, such as those for fuel injection lines or jet pumps, and then compare them with standard waveforms.

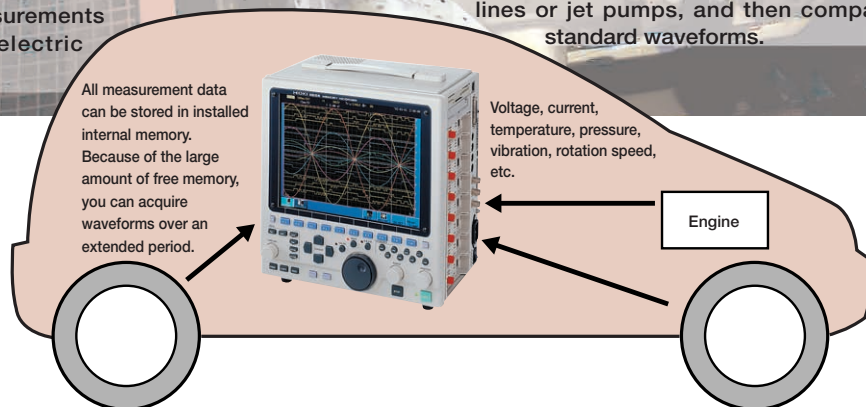

I want to observe carrier and basic waveforms simultaneously with high-speed switching, such as inverter waveforms

I'd like to observe the load fluctuation waveforms that result when power is turned on or off simultaneously with the control logic signals

HIOKI has met these requests by providing the **MEMORY HiCORDER 8855** with isolated input for all channels, a sampling rate of up to 20 MS/s, digital conversion with a resolution of 12 bits, and the ability to measure up to 8 analog and 16 control logic channels simultaneously.

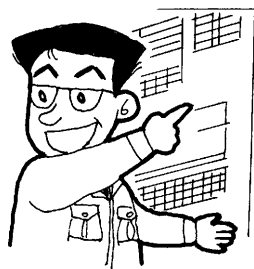

I'd like to view waveforms that occur during the 5 seconds after the power is turned on and the device stabilizes

I want to record data for all sporadic abnormalities that occur during automobile testing without using triggers

In response to these requests, the **MEMORY HiCORDER 8855** supports large-capacity memory, which can be expanded to up to 512 megawords (1 GB). Even at a sampling rate of 20MS/s, the **8855** can record for up to 12.8 seconds (2 channels, with a maximum of 256 megawords/channel) of data.

Compatible with F/V and temperature input

Use the optional F/V conversion input unit to observe control and rotation signals as waveforms, or the temperature input unit for thermocouple measurements. Depending on your application needs, select from a wide array of input units to configure your ideal measurement system.

Zoom function

When observing waveforms using an analog oscilloscope, you can slow down the sweep rate to view the entire waveform or speed it up to zoom in on the waveform. However, you can only observe enlarged waveforms following a trigger point. As you observe waveforms, you can use the zoom function to enlarge selected points on the waveforms.

Recorder and memory function (available from version 2.00 of this unit)

When recording envelope waveforms in recorder mode, the **8855** can be used to capture sporadic signal waveforms in memory mode.



20 MS/s high-speed sampling for all channels using isolated input

- Functions -

Can I use the 8855 to measure high voltages, such as inverter output ?

When measuring the difference in electrical potential between two signals that have a large overlapping common mode voltage, electric shock may result if you are not using a measurement unit with completely insulated input channels like the **MEMORY HiCORDER 8855**. Further, when measuring signals with a superimposed common mode voltage that includes high frequency components, such as inverter control and switching power circuit signals, the frequency characteristics for the common mode removal comparison of the insulated area greatly affect the measurement results. For example, when using the **ANALOG UNIT 8950**, the peak-to-peak value for all waveform data can be measured or displayed in a range configuration of up to 280 V RMS using the memory function. If you want to measure voltages that exceed 280 V, you can use the optional **DIFFERENTIAL PROBE 9322** to measure voltages up to 2000 V DC or 1000 V AC. Because a maximum voltage to ground of 1500 V AC/DC (CAT II) is possible, you can measure the common mode voltage for larger systems than before.

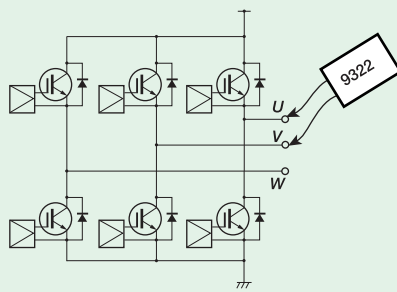
Using the DIFFERENTIAL PROBE 9322

Three-phase inverter output system
(Since the electric potential of the emitter is different for each phase, floating measurement is indispensable.)

Measuring the surge noise for power lines (using the DIFFERENTIAL PROBE 9322 in AC mode)
If you select AC as the output mode, the signal connected to AC is divided to 1/1000 inside the probe and output. Because the frequency range can be set between 1 kHz and 10 MHz, the output waveform is displayed only when a voltage signal that includes a high waveform component is input, such as surge noise superimposed on a 50/60 Hz commercial power line. Therefore, the 8855 can be used primarily to detect noise, as well as to measure the height of waves.

Rectified RMS voltages can be output (using the DIFFERENTIAL PROBE 9322 in RMS mode)
When RMS is selected as the output mode, the input signal voltage is divided to 1/1000, then true RMS value rectification is performed, and the DC voltage output. RMS value rectification is performed by analog circuitry, and because the bandwidth extends from 40 Hz to 100 kHz, signals that include harmonic components can be accurately converted to RMS values not only for 50/60 Hz commercial power lines, but for other waveforms containing harmonics, such as inverter output waveforms.

Can I observe distorted current, such as that of inverter output ?

Observation of distorted current is possible when using the 8855 in combination with the **VOLTAGE/CURRENT UNIT 8951** and a clamp-on probe or clamp-on sensor. Especially when using the **CLAMP ON PROBES 3273-50, 3274, 3275, or 3276**, you can accurately observe current waveforms ranging from very small to very large with a highly linear response for current frequencies from DC voltage to high frequencies.

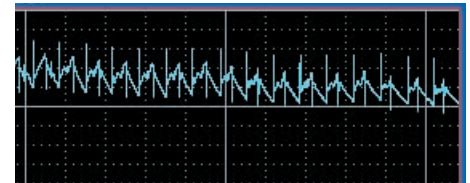
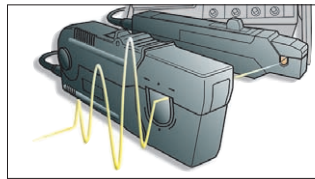

Actual measurement example for inverter current using the 8855 in combination with the 3274

CLAMP ON PROBES 3273-50/3274/3275/3276
(rectangular waveform response characteristic)

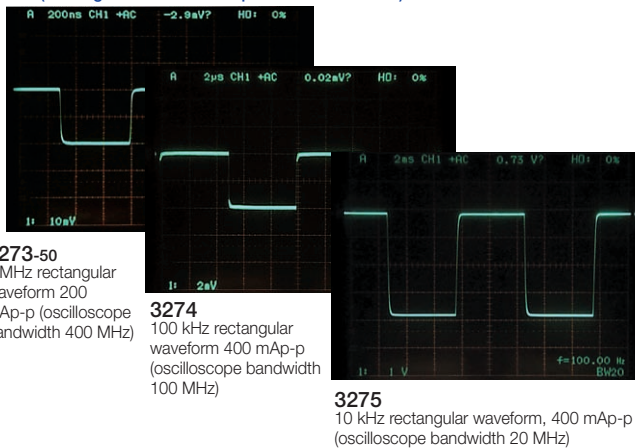

CLAMP ON PROBES 3273-50/3274/3275/3276
(when measuring very low current with high S/N characteristics)

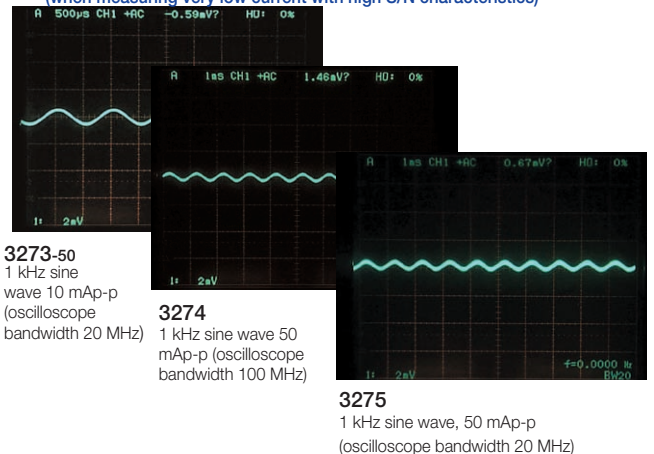

Using the trigger function during data capture and the trigger search function after data has been captured

The trigger function allows you to set various conditions for input waveforms in order to capture waveform anomalies. It is convenient for analyzing the causes of anomalies, since a pretrigger can be set, enabling you to observe waveforms before starting the trigger search. In contrast to above, this function allows you to search for and display anomalous waveforms in captured data using the same criteria used for the trigger function during measurement. If triggers cannot be set during measurement because you do not know what sort of waveforms will be displayed, you can search for anomalies using the trigger search function once all of the data has been captured.

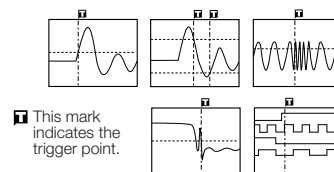

Use the 8855 to capture power line noise:

In order to capture events such as impulse noise caused by lightning strikes and the opening and closing of solenoids, and voltage surge noise (voltage swells) caused by switching power lines with heavy loads, the 8855 comes equipped with window out trigger and glitch trigger functions.

Use the 8855 to capture instantaneous power outages on power lines:

Using the window out trigger and trigger filter functions, you can capture instantaneous power outages due to events such as lightning strikes and breaker tripping due to short circuits.

Perfect for inspecting storage media such as CDs, MOs, DVDs, and HDDs

- Application Examples -

Analyzing operation of digital A/V equipment

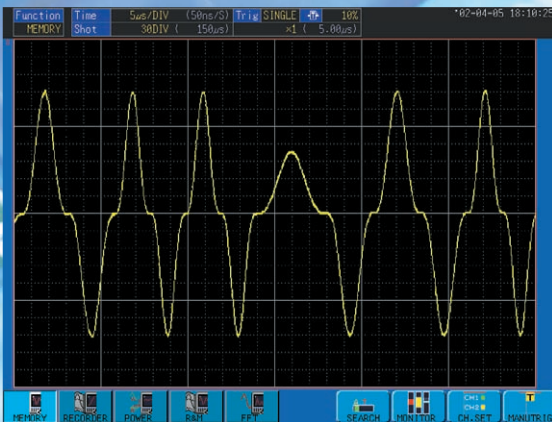

Single-track data, such as that on hard disks, can be batch recorded into the long memory and then scanned for corrupted bits.

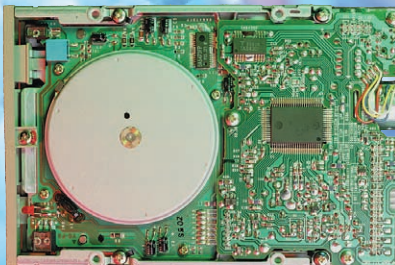

When equipped with its maximum memory capacity, the 8855 is useful for designing and analyzing digital A/V, communications, and information-related equipment, and for inspecting production lines. By observing high-speed logic signals and analog waveforms simultaneously, you can determine the control sequence at a glance.

Observing signals from magnetic data



When maintaining or inspecting equipment that uses magnetic cards (such as the automated wickets at railway stations), the data read can be batch recorded and anomalies observed using the waveform search or zoom functions.

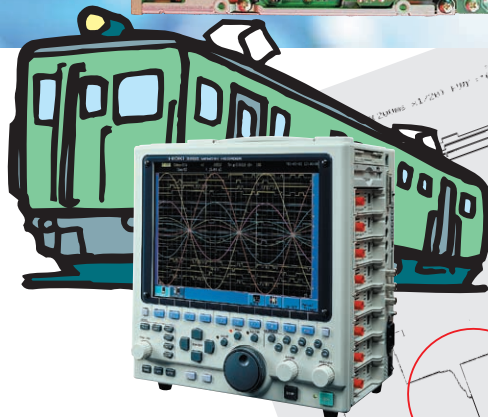

Railway car defect analysis

All data for current waveforms of the main power motor and correlating waveforms of relay signals can be recorded on the 8855. Print the data using the optional printer.

- Investigation of notch curves and cam synchronizer waveforms
- Main circuit current waveform recording by clamp meter
- Waveform recording of cam contact signals by logic probe
- Waveform recording of cam contact signals using analog input
- Investigation of electric brakes
- Waveform recording of MG starting current by clamp meter

I'd like to observe the control signal from a CPU, signals from the various sensors, and the actual movement all at the same time

I'd like to observe the load fluctuation waveforms that result when power is turned on or off simultaneously with the control logic signals

HIOKI has met these requests by providing the MEMORY HiCORDER 8855 with isolated input for all channels, a sampling rate of up to 20 MS/s, digital conversion with a resolution of 12 bits, and the ability to measure up to 8 analog and 16 control logic channels simultaneously.

1 MS/s and 16-bit high resolution

With the 8855, measurement can be stored with a resolution of 16 bits. This allows more precise verification of signal waveforms. With its high sampling speed of 1 MS/s, the 8855 can be used for detailed signal analysis.

Sequential saves assures minimal dead time

This function allows you to divide a large amount of free memory into small blocks and save the waveforms from each trigger in these blocks. Reducing the amount of dead time during sequential saves means that continuously occurring triggers are not missed. (Minimum setting of approximately 1 ms)

FFT function

(available with version 2.00 of this unit)

FFT capabilities include single-signal FFT for spectral analysis, two-signal FFT for transfer function analysis, and octave analysis for acoustic analysis. This is a very convenient function because FFT analysis can be performed for any portion of an extended waveform captured by the memory recorder.

I want to capture all the data from a single track of a DVD

During maintenance of equipment that uses magnetic cards, I want to record all data read at once to make it possible to identify errors

In response to these requests, the MEMORY HiCORDER 8855 supports large-capacity memory. The memory of the 8855 can be expanded to up to 512 megawords (1 GB). Even at a sampling rate of 20MS/s, the 8855 can record for up to 12.8 seconds (2 channels, with a maximum of 256 megawords/channel)

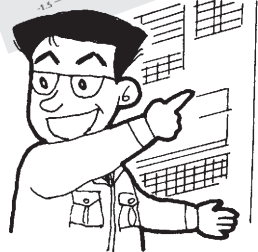

Complete data capturing with a large capacity 1 Gbyte memory (optional)

- Functions -

How long can I record to the internal memory ?

The 8855 comes equipped with a standard memory capacity of 32 Mwords, but you can increase this by four times (128 Mwords total) or as much as 16 times (512 Mwords total) by using the optional memory available. The maximum recording times are displayed in the table on the right according to the time axis range setting.

Internal memory recording times

Time axis	Sampling period	2-ch setting, 32 MW with standard memory capacity Max. recording 100,000 DIV	2-ch setting, 128 MW with expanded memory capacity Max. recording 500,000 DIV	2-ch setting, 512 MW with expanded memory capacity Max. recording 2,000,000 DIV
5 μ s/DIV	50ns	0.5 s	2.5 s	10 s
10 μ s/DIV	100ns	1 s	5 s	20 s
20 μ s/DIV	200ns	2 s	10 s	40 s
50 μ s/DIV	500ns	5 s	25 s	1 m 40 s
100 μ s/DIV	1 μ s	10 s	50 s	3 m 20 s
200 μ s/DIV	2 μ s	20 s	1 m 40 s	6 m 40 s
500 μ s/DIV	5 μ s	50 s	4 m 10 s	16 m 40 s
1ms/DIV	10 μ s	1 m 40 s	8 m 20 s	33 m 20 s
2ms/DIV	20 μ s	3 m 20 s	16 m 40 s	1 h 6 m 40 s
5ms/DIV	50 μ s	8 m 20 s	41 m 40 s	2 h 46 m 40 s
10ms/DIV	100 μ s	16 m 40 s	1 h 23 m 20 s	5 h 33 m 20 s
20ms/DIV	200 μ s	33 m 20 s	2 h 46 m 40 s	11 h 6 m 40 s
50ms/DIV	500 μ s	1 h 23 m 20 s	6 h 56 m 40 s	1 day 3 h 46 m 40 s
100ms/DIV	1ms	2 h 46 m 40 s	13 h 53 m 20 s	2 days 7 h 33 m 20 s
200ms/DIV	2ms	5 h 33 m 20 s	1 day 3 h 46 m 40 s	4 days 15 h 6 m 40 s
500ms/DIV	5ms	13 h 53 m 20 s	2 days 21 h 26 m 40 s	11 days 13 h 46 m 40 s
1s/DIV	10ms	1 day 3 h 46 m 40 s	5 days 18 h 53 m 20 s	23 days 3 h 33 m 20 s
2s/DIV	20ms	2 days 7 h 33 m 20 s	11 days 13 h 46 m 40 s	46 days 7 h 6 m 40 s
5s/DIV	50ms	5 days 18 h 53 m 20 s	28 days 22 h 26 m 40 s	115 days 17 h 46 m 40 s
10s/DIV	100ms	11 days 13 h 46 m 40 s	57 days 20 h 53 m 20 s	231 days 11 h 33 m 20 s
30s/DIV	300ms	34 days 17 h 20 m	173 days 14 h 40 m	-Abbreviated-
1min/DIV	600ms	69 days 10 h 40 m	347 days 5 h 20 m	-Abbreviated-
2min/DIV	1.2s	138 days 21 h 20 m	-Abbreviated-	-Abbreviated-
5min/DIV	3.0s	347 days 5 h 20 m	-Abbreviated-	-Abbreviated-

Data compatibility with PCs

Large volumes of stored waveform data can be analyzed and processed using a PC. Media such as MOs, PC cards, or floppy disks, or interfaces such as LAN or SCSI can be used to transfer data.

FTP service

(to be supported from version 2.00 of this unit)

By using FTP client software from your PC, you can access the files stored on media installed in the 8855.

PPP connect function

(available from version 2.10 of this unit)

Using a modem card, you can connect the LAN to your PC via a telephone line using PPP. This enables you to connect a PC in your office to an 8855 set up in a remote location using a modem, and to access files via FTP or the LAN COMMUNICATOR 9333.

(Fixed recording length) When you select the alternate recording length, the maximum number of divisions changes from 100,000 to 160,000, 500,000 to 640,000, and 2,000,000 to 2,560,000 respectively.

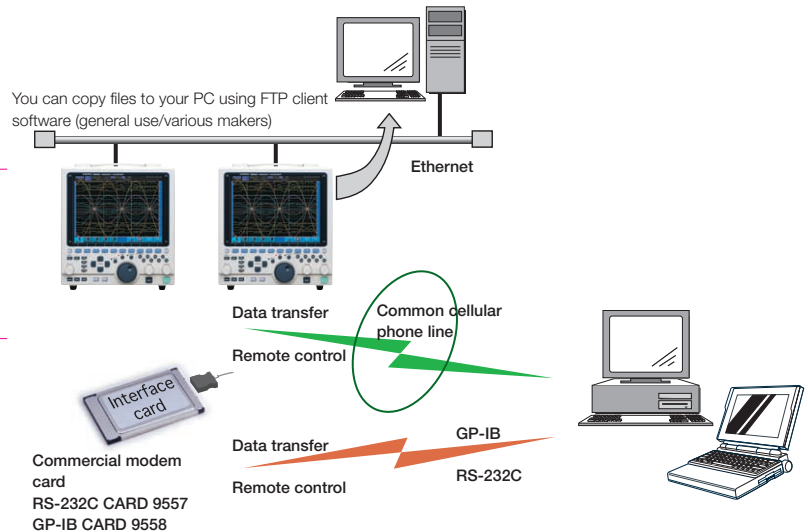

Calculation function

Waveforms captured in memory mode can be processed through such operations as the four basic arithmetic operations, as well as differentiation and integration. Furthermore, maximums and other parameters of the observed waveform data can be displayed. Using this function, signals can be analyzed in a many different ways.

Waveform judgment function

After defining a reference waveform area, you can use area judgment to check whether the waveform displayed on the screen extends outside that area. With parameter judgment, you can evaluate results of numeric calculation with set values.

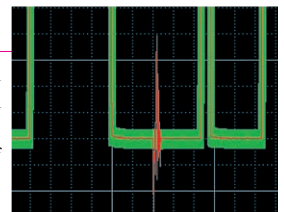

Scaling function

Actual measurements usually involve parameters other than voltage. Therefore, various physical parameters such as speed, vibration, or temperature commonly need to be monitored. In such measurement conditions, the scaling function can be used to automatically convert to the desired parameter.

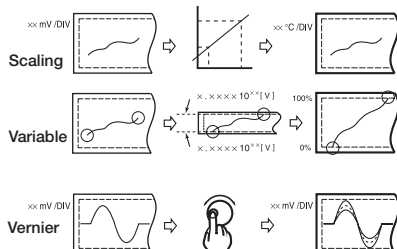

X-Y waveform display

The 8855 allows you to observe X-Y composite waveforms (Lissajous waveforms) that occur between two signals. Any channel can be set as the X or Y axis. In addition to its composition capacity in memory mode, the 8855 can display real-time images of unlimited recording time in recorder mode.

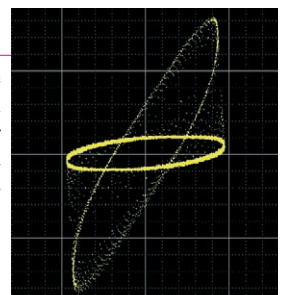

An X-Y measurement image

- Specifications -

Basic specifications (MEMORY HiCORDER 8855)	
Measurement functions	MEM, REC, REC & MEM (Ver. 2.00 or later), FFT (Ver. 2.00 or later), Power Monitor (optional function, sold separately)
Input type and number of channels	Plug-in input modules Analog (up to 8 channels) + logic (16 channels standard) Isolated analog channels, isolated input and frame, logic has common GND.
Maximum sampling rate	20 MS/s (50 ns cycle) Simultaneous sampling for 8 analog + 16 logic channels
Memory capacity	Standard: 32 Mwords total (12 analog bits + 4 logic bits) × 16 Mwords/channel (2 channels used) to (12 analog bits + 4 logic bits) × 4 Mwords/channel (8 channels used) With the 9645: 128 Mwords total (12 analog bits + 4 logic bits) × 64 Mwords/channel (2 channels used) to (12 analog bits + 4 logic bits) × 16 Mwords/channel (8 channels used) With the 9645-01: 512 Mwords total (12 analog bits + 4 logic bits) × 256 Mwords/channel (2 channels used) to (12 analog bits + 4 logic bits) × 64Mwords/channel (8 channels used)
File storage	Floppy disk drive × 1: 1.44MB, 1.2MB, 720KB, MS-DOS format Type II PC card slot × 1: flash ATA cards, MS-DOS format MO drive (optional) × 1: 1.3GB, 640MB, 540MB, 230MB, 128MB, ISO format, media overwrite supported Hard disk drive (optional) × 1: 20GB, MS-DOS format
Battery backup (Reference at 25°C/77°F)	Clock and settings: approx. 10 years, waveform backup: minimum of 1 hour with standard memory (32MW), minimum of 20 minutes with the 9645 installed (128MW) , minimum of 4 minutes with the 9645-01 installed (512MW)
External control connector	BNC connector: external trigger input, trigger output, external sampling input Terminal block: GO/NG output, external start/stop, EXT. OUT output
Interface ⁸¹	LAN: RJ-45 connector, Ethernet 10 BASE-T SCSI: can connect to an MO drive ⁸¹ , shielded 50-pin high-density type (D-sub half pitch)
Interface (optional, sold separately) This function is to be supported from version 2.00 of this unit.	GP-IB: GP-IB CARD 9558 used, remote control and data transfer possible, IEEE standard 488.2-1987. RS-232C: RS-232C CARD 9557 used, remote control and data transfer possible, EIA standard RS-232C.
Environment (no condensation)	Operation: 5°C (41°F) to 40°C (104°F), 30 to 80% rh Storage: -10°C (14°F) to 50°C (122°F), 20 to 90% rh
Applicable standards	Safety: EN61010 EMC: EN61326, EN61000-3-2, EN61000-3-3
Power	100 to 240V AC (50/60Hz)
Power consumption	180VA max. (280VA max. when using the printer unit)
Dimensions and mass	Approx. W 275mm (10.83in) × H 285mm (11.22in) × D 170mm (6.69in), approx. 6.3kg (222.2oz) Approx. 7.1kg (250.4oz) (printer attached), approx. 7.7kg (271.6oz) (printer and MO units attached)
Supplied accessories	Instruction Manual ×2, Guide ×1, Power cord ×1, PC card protector ×1, Input cord label ×1, Application disc (Wave viewer software Wv, Communication command table) ×1, (Recording paper ×1, Paper attachments ×2, with the optional PRINTER UNIT 8994)

Recording and display⁸² The recording function is available when using the optional PRINTER UNIT 8994.

Display method	10.4-inch TFT color LCD, with English/Japanese selector 800 × 600-pixel resolution
*2Printer paper	216mm (8.5in) × 30m (98.4ft), thermal paper roll
*2Recording width	20 divisions in full scale, 1 division = 10mm (0.39in) (80pixels)
*2Paper feed density	10rows/mm (250rows/in) 20rows/mm (500rows/in) using the memory recorder's smooth print function.
*2Recording speed	Max. 20mm/s (0.79in/s)

Trigger function (Dual-edge trigger is available from version 2.50)

Trigger source	Analog input channels (1 to 8), logic input channels (A to D), external, timer, manual (either ON or OFF for each source), AND/OR sources Level: Triggered both when the signal rises above or falls below the set voltage value. Window: Triggered when rising above or falling under the defined level range.
Trigger types (Analog)	Period: Triggered when the rising or falling edges of the set voltage value do not fall within the set cycle. Glitch: Triggered when the set voltage value rises above or falls below the set pulse width. Event: Triggered when the rising or falling edges of set voltage exceeds the set number of events.
Level setting resolution	equivalent to 0.1% when the full scale is set to 20 divisions
Trigger types (Logic)	Pattern setting 1, 0, or x, AND/OR set for 4 channels
Trigger filter (analog/logic)	0.1 to 10.0 divisions, 9 settings or OFF (MEM, REC & MEM functions) ON/OFF (REC function)
Other functions	Pre-trigger function to capture pre- and post-trigger waveform, trigger output (active Low with BNC terminal and open collector 5 voltage output), Level display while waiting for trigger, Start & Stop trigger in REC function.



The 8855 uses plug-in type input amps. They can be replaced depending on the type of signal being measured.



The LOGIC PROBE 9327 or 9321-01 is necessary to measure logic signals. Up to four logic probes can be connected to the 8855, which means that it can support 16 channels.



The 8855 comes equipped with a TYPE II PC card slot. Both memory cards and interface cards can be used.

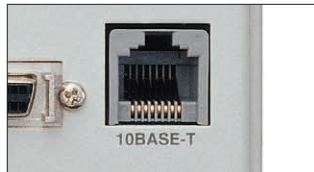

The 8855 comes equipped with a standard 10 BASE-T Ethernet terminal. Remote operations from the PC and data collection can be performed easily when the 8855 is connected to a LAN. The 8855 operation program for use with Windows is optional.

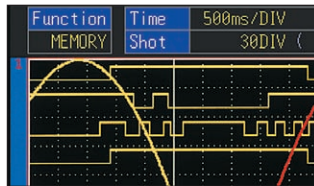

Signals can be easily differentiated on the color screen. The 8855 uses a TFT display with a resolution of 800 × 600 pixels, which is higher than the resolution of similar devices. This allows you to perform high-resolution waveform observation.



The 8855 uses an analog dial to change the oscillation and zero point. This makes observation of signals from several channels easy (up to 8 channels).



Optionally, a 1.3GB MO drive or a 20GB hard disk drive can be added. Measurement data can be saved on these high capacity media.

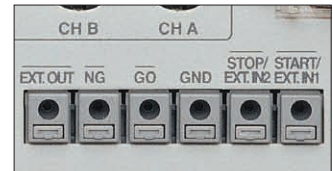

In addition to the external start and stop controls, other operations can be assigned to terminals.



The 8855 comes equipped with a standard SCSI interface that can use external MO drive connections or the existing internal MO or HD as an external PC drive. This can be used when copying data to a PC.

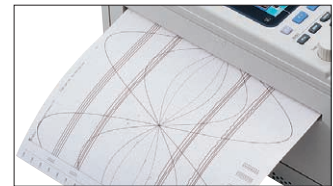

Installing the special thermal printer unit in the 8855 allows you to print the waveforms that you observe right away. With a paper width of 216mm (8.5in), the printer is ideal for printing signals from several channels.

(A 110mm (4.3in) wide printer is also available by special order. For more information, please consult your local HIOKI dealer.)

- Specifications -

Memory function	
Time axis	5 μ s to 5 minutes/DIV (100 samples/DIV), 24 settings; external sampling (number of sampling points/DIV, desired setting), time axis zoom 2x to 10x, 3 settings; compression 1/2 to 1/100,000, 15 settings
Sampling period	1/100 of time axis ranges (minimum sampling period of 50ns)
Recording length	Standard configuration (32Mwords): 1 DIV steps possible, 30 to 100,000 ^{*3} DIV With expanded memory (128Mwords): 1 DIV steps possible, 30 to 500,000 ^{*3} DIV With expanded memory (512Mwords): 1 DIV steps possible, 30 to 2,000,000 ^{*3} DIV ^{*3} When using 2 channels, the max. recording length depends on the number of channels being used.
Pretrigger	Can record data from before the trigger point, 0 to 100% or -95 % of recording length; 15 settings
Other functions	Waveform processing, waveform parameter processing, averaging, memory segmentation (max. 1024 segments), logging (numerical printout), X-Y waveform plot, voltage axis zoom $\times 2$ to $\times 100$ (6 settings), compression 1/2, zoom, variable display, graph superimposition

Recorder function	
Time axis	10ms to 1 hour/DIV (17 settings), 1 DIV = 100 samples, time axis compression 1/2 to 1/10,000 (12 settings) 10 ms to 200 ms/division real-time recordings cannot be printed, but waveforms can be saved to memory and displayed on the screen. 10,000 divisions worth of these waveforms are recorded from the end of measurement. Furthermore, the printer can be operated simultaneously when the recording length is set to anything other than "continuous" and waveforms can be printed later.
Sampling period	1 μ s to 100ms, 6 settings; restrictions apply depending on time axis range
Recording length	Standard configuration (32Mwords): 1 DIV steps possible, 30 to 20,000 DIV, "continuous" ^{*4} With expanded memory (128Mwords): 1 DIV steps possible, 30 to 50,000 DIV, "continuous" ^{*4} With expanded memory (512Mwords): 1 DIV steps possible, 30 to 200,000 DIV, "continuous" ^{*4} Only continuous for X-Y recording. ^{*4} When time is 10 ms to 200 ms/DIV and printer is ON, continuous is not available.
X-Y sampling period	300 μ s; fixed (dot), 300 μ s to 25ms (line)
X-Y axis resolution	25 pixel/DIV (display), 80 pixels/DIV \times 80 pixels/DIV (printer)
Waveform storage	The last 20,000 ^{*5} DIV of data are saved in memory, reverse scroll observation and reprinting. ^{*5} 80,000 DIV when the memory is expanded to 128Mwords, 320,000 DIV when the memory is expanded to 512Mwords
Other functions	Logging (numerical printout), virtual recording (data is written to the internal memory without the use of printer paper), additional recording (recording is resumed without overwriting previous data), voltage axis magnification $\times 2$ to $\times 100$ (6 settings), compression 1/2 (1 setting), variable display, 8 screen divisions (X-Y up to 4 screen divisions)

REC & MEM function (available from version 2.00 of this unit)	
Time axis (REC)	10ms to 1 hour/DIV (17 settings), 1 DIV = 100 samples, time axis compression 1/2 to 1/5,000 (11 settings); Sampling period is 1 μ s to 100ms, 6 settings
Time axis (MEM)	10 μ s to 5minutes/DIV (24 settings), time axis zoom $\times 2$ to $\times 10$ (3 settings), compression 1/2 to 1/100,000 (15 settings); sampling period is 1/100 (min. 50ns) of a time axis
Recording length	REC: 30 to 10,000 ^{*6} DIV, or continuous ^{*6} , MEM: 30 to 100,000 ^{*6} DIV ^{*6} Depends on the increased memory capacity (divided in 1 DIV steps)
Trigger source	REC: timer trigger, OFF, MEM: Analog channels (1 to 8), logic channels (A to D), external trigger
Other functions	During operation only REC waveforms can be printed, whereas when the unit is stopped REC waveforms or MEM waveforms can be printed depending on the screen display. The last 10,000 ^{*6} DIV of data are saved in memory, additional recording (recording is resumed without overwriting previous data), zoom, variable display

FFT function (available from version 2.00 of this unit)	
Analysis mode	Waveform storage, linear spectrum, RMS spectrum, power spectrum, autocorrelation function, histogram, octave analysis, transfer function, cross-power spectrum, cross-correlation function, impulse response, coherence function
Analysis channels	1 or 2 channels selected among the analog channels
Frequency range	133mHz to 8MHz, resolution 1/400, 1/800, 1/2000, 1/4000
Number of sampling points	1000, 2000, 5000, 10000 points
Window functions	Rectangular, Hanning, Exponential
Averaging	Simple average of the time or frequency axis, indexation average, peak hold

Auxiliary functions	
Waveform judgment function (Memory recorder) (FFT)	Type: Area determination using reference waveforms for time axis waveforms, X-Y plot, or FFT display. Parameter judgment of waveform parameter processing. Judgment output: pass/fail output, open-collector S-V output
General	FTP service (to be supported from version 2.00 of this unit), PPP connection function (to be supported from version 2.10 of this unit), scaling, Vernier function, pulse count function, waveform search function, cursor measurement, comment insertion, other functions



The time axis can be modified by turning a dial. Modifying the time axis alters the sampling rate.

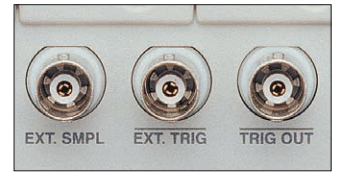

Synchronized sampling is possible for external signals (up to 10MS/s). Furthermore, external trigger input and output signals are also available.



Use the jog shuttle knob like the one used on video equipment to scroll or change the settings of the waveform being observed. The jog shuttle knob puts smooth waveform scrolling right at your fingertips.

External appearance and dimensions (8855 base unit only)

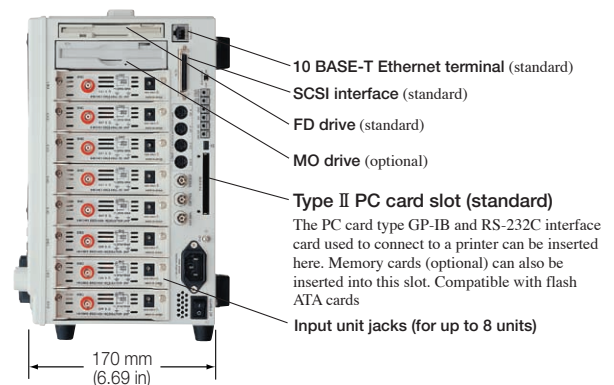
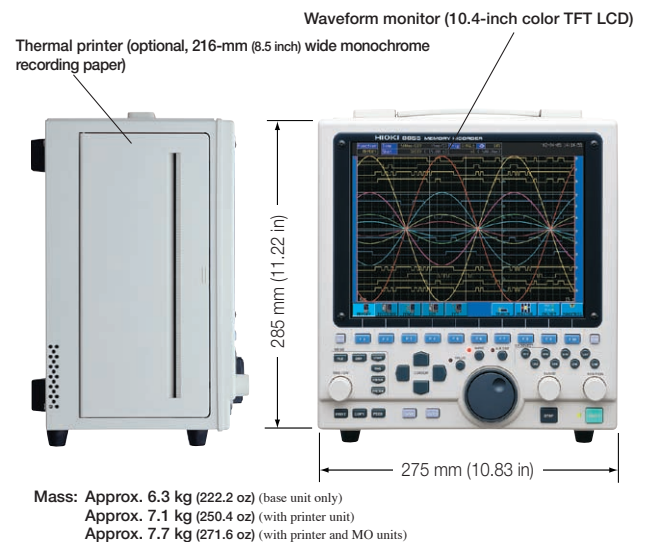

PC Software Specifications

Wave Viewer (Wv) Software (Application disk CD-R, bundled accessory)	
Functions	<ul style="list-style-type: none"> Quick display of waveform files Text conversion: Conversion of binary data files to text format, with storage in either CSV or space/tab delimited format. Span specification and data culling available. Display format settings: scroll function, enlarge/reduce display, display CH settings. Other: Voltage trace function, jump to cursor/trigger position function, etc.
Compatible operating systems	Windows 95/98/Me or Windows NT 4.0 (SP3 or later), 2000, XP

Options (sold separately)

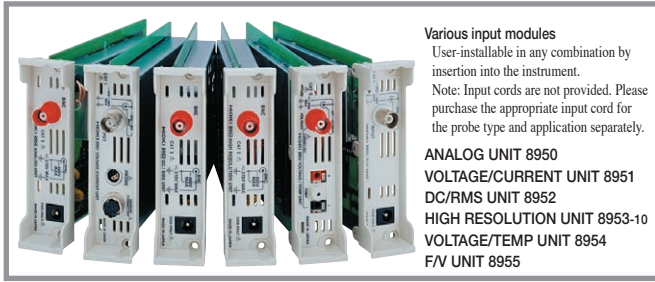

Various input modules
User-installable in any combination by insertion into the instrument.
Note: Input cords are not provided. Please purchase the appropriate input cord for the probe type and application separately.

ANALOG UNIT 8950
VOLTAGE/CURRENT UNIT 8951
DC/RMS UNIT 8952
HIGH RESOLUTION UNIT 8953-10
VOLTAGE/TEMP UNIT 8954
F/V UNIT 8955

Measurement type	Unit	Display range	Maximum resolution
Voltage	ANALOG UNIT 8950	100 mV f.s. to 400 V f.s.	50 μ V
	VOLTAGE/CURRENT UNIT 8951	20 mV f.s. to 60 V f.s.	10 μ V
	DC/RMS UNIT 8952	100 mV f.s. to 400 V f.s.	50 μ V
	HIGH RESOLUTION UNIT 8953-10	100 mV f.s. to 400 V f.s.	3.125 μ V
	VOLTAGE/TEMP UNIT 8954	10 mV f.s. to 40 V f.s.	0.3125 μ V
Current (using 8951 VOLTAGE /CURRENT UNIT)	Using the CLAMP SENSORS 9270, 9272 (20 A), 9277, or 3273-50: <small>*The maximum value differs depending on the clamp sensor used.</small>	200 mA f.s. to 20* A f.s.	100 μ A
	Using the CLAMP SENSORS 9271, 9272 (200 A), 9278, 3274, or 3273: <small>*The maximum value differs depending on the clamp sensor used.</small>	2 A f.s. to 200* A f.s.	1mA
	Using the CLAMP ON SENSOR 3275 <small>*The maximum value differs depending on the clamp sensor used.</small>	2 A f.s. to 500* A f.s.	1mA
	Using the UNIVERSAL CLAMP ON CT 9279 <small>*The maximum value differs depending on the clamp sensor used.</small>	4 A f.s. to 500* A f.s.	2.5mA
AC RMS voltage	DC/RMS UNIT 8952	100 mV f.s. to 400 V f.s.	50 μ V
Temperature (thermocouple input)	VOLTAGE/TEMP UNIT 8954	200 °C f.s. to 2000 °C f.s. <small>*The maximum and minimum values differ depending on the thermocouple used.</small>	0.01 °C
Frequency, RPM	F/V UNIT 8955	2 Hz f.s. to 100 kHz f.s. 200 (r/min) f.s. to 10 (kr/min) f.s.	0.5mHz 0.05 (r/min)
Power frequency	F/V UNIT 8955	40 Hz f.s. to 60 Hz f.s. 50 Hz f.s. to 70 Hz f.s.	5mHz
Pulse integration	F/V UNIT 8955	—	0.05counts
Pulse duty comparison	F/V UNIT 8955	100 % f.s.	0.05%
Pulse width	F/V UNIT 8955	0.01 s to 2 s	2.5 μ s

Dimensions and mass: approx. 104.7(4.1 in)W × 28(1.1 in)H × 164.5(6.5 in)D mm
approx. 150 g (5.3 oz) **Supplied accessories:** None



ANALOG UNIT 8950	
(Accuracy at 23 ±5°C (73 ±9°F) and 30 to 80% relative humidity when zero-adjust is performed after a 30-minute warm-up; accuracy guaranteed for 1 year)	
Measurement functions	Number of channels: 1, voltage measurement
Input	Isolated BNC connector, Max. rated voltage to earth: 370V AC, DC (with input isolated from the unit, the maximum voltage that can be applied between input channels and chassis, or across input pins, without causing damage)
Measurement range	5mV to 20V/DIV, 12 ranges, full-scale = 20DIV, AC voltage for possible measurement / display using the memory function: 280V rms, low-pass filter: 5Hz/500Hz/5kHz/1MHz
Measurement resolution	Data in the 1/100 measurement range (using 12-bit A/D)
Maximum sampling rate	20MS/s
Accuracy	DC amplitude: ±0.4% f.s. Zero-position: ±0.1% f.s.
Frequency characteristics	DC to 10MHz ±3 dB. With AC coupling: 7Hz to 10MHz ±3dB
Input resistance and capacitance	1M Ω , 40pF (when C is 100kHz)
Input coupling	DC, GND, AC
Max. allowable input	400V DC (the maximum voltage that can be applied between input pins without causing damage)
Power terminal	DIFFERENTIAL PROBE 9322 Power (the POWER CORD 9328 is required for connection)

Dimensions and mass: approx. 104.7(4.1 in)W × 28(1.1 in)H × 164.5(6.5 in)D mm
approx. 190 g (6.7 oz) **Supplied accessories:** None



VOLTAGE/CURRENT UNIT 8951	
(Accuracy at 23 ±5°C (73 ±9°F) and 30 to 80% relative humidity when zero-adjust is performed after a 30-minute warm-up; accuracy guaranteed for 1 year)	
Measurement functions	Number of channels: 1, voltage measurement/current measurement using a clamp
Input	Metal BNC connector, Max. rated voltage to earth: 30V RMS or 60V DC (with input isolated from the unit, the maximum voltage that can be applied between input channels and chassis, or across input pins, without causing damage, ±12V common ground for installed units when using a clamp) Sensor connector: 9270s clamp sensor input (±12V common ground for installed units)
Voltage measurement range	1mV to 5V/DIV, 12 ranges, full-scale = 20DIV, AC voltage for possible measurement / display using the memory function: 30V rms, low-pass filter: 5Hz/500Hz/100kHz/1MHz
Current measurement range	With the 9270, 9272 (20 A), 9277, or 3273-50, 3276: 10mA to 5A/DIV, 9 ranges, full-scale = 20DIV With the 9271, 9272 (200 A), 9278, or 3274: 100mA to 50A/DIV, 9 ranges, full-scale = 20DIV With the 9279 : 200mA to 100A/DIV, 9 ranges, full-scale = 20DIV With the 3275 : 100mA to 100A/DIV, 10 ranges, full-scale = 20DIV Low-pass filter: 5Hz/500Hz/100kHz/1MHz (1MHz: 3273-50 to 3276, 100kHz: When using the 3273-50 to 3276, 9277, or 9278)
Measurement resolution	Data in the 1/100 measurement range (using 12-bit A/D) (With the 9279: part of the current range or in the 1/80 measurement range)
Maximum sampling rate	20MS/s
Accuracy	DC amplitude: ±0.5% f.s. Zero-position: ±0.15% f.s. (add the accuracy and characteristics of the sensor or probe used when measuring current)
Frequency characteristics	DC to 4MHz ±3dB, With AC coupling: 7Hz to 4MHz ±3dB
Input resistance and capacitance	1M Ω , 50pF (when C is 100kHz)
Input coupling	DC, GND, AC
Max. allowable input	30V rms or 60V DC (the maximum voltage that can be applied between input pins without causing damage)
Power terminal	±12V for the 3273-50/3274/3275/3276 (common ground with the power terminals of installed units)

Dimensions and mass: approx. 104.7(4.1 in)W × 28(1.1 in)H × 164.5(6.5 in)D mm
approx. 150 g (5.3 oz) **Supplied accessories:** None



DC/RMS UNIT 8952	
(Accuracy at 23 ±5°C (73 ±9°F) and 30 to 80% relative humidity when zero-adjust is performed after a 30-minute warm-up; accuracy guaranteed for 1 year)	
Measurement functions	Number of channels: 1, voltage measurement
Input	Isolated BNC connector, Max. rated voltage to earth: 370V AC, DC (with input isolated from the unit, the maximum voltage that can be applied between input channels and chassis, or across input pins, without causing damage)
Measurement range	5mV to 20V/DIV, 12 ranges, full-scale = 20DIV, AC voltage for possible measurement / display using the memory function: 280V rms, low-pass filter: 5Hz/500Hz/5kHz/1MHz
Measurement resolution	Data in the 1/100 measurement range (using 12-bit A/D)
Maximum sampling rate	20MS/s
Accuracy	DC amplitude: ±0.4% f.s. (with 5Hz filter ON and averaging ON) Zero-position: ±0.1% f.s.
RMS accuracy	±2% f.s. (DC, 10Hz to 15kHz) ±8% f.s. (with 50 to 500kHz, sine wave input, when response is SLOW)
Frequency characteristics	DC to 10MHz ±3dB. With AC coupling: 7Hz to 10MHz ±3dB
Input resistance and capacitance	1M Ω , 40pF (when C is 100kHz)
Input coupling	DC, GND, AC
Max. allowable input	400V DC (the maximum voltage that can be applied between input pins without causing damage)
Power terminal	DIFFERENTIAL PROBE 9322 Power (the POWER CORD 9328 is required for connection)

Dimensions and mass: approx. 104.7(4.1 in)W × 28(1.1 in)H × 164.5(6.5 in)D mm
approx. 150 g (5.3 oz) **Supplied accessories:** None



HIGH RESOLUTION UNIT 8953-10	
(Accuracy at 23 ±5°C (73 ±9°F) and 30 to 80% relative humidity when zero-adjust is performed after a 30-minute warm-up; accuracy guaranteed for 1 year)	
Measurement functions	Number of channels: 1, voltage measurement
Input	Isolated BNC connector, Max. rated voltage to earth: 370V AC, DC (with input isolated from the unit, the maximum voltage that can be applied between input channels and chassis, or across input pins, without causing damage)
Measurement range	5mV to 20V/DIV, 12 ranges, full-scale = 20DIV, AC voltage for possible measurement / display using the memory function: 280V rms, low-pass filter: 5Hz/50Hz/500Hz/5kHz/50kHz
Measurement resolution	Data in the 1/1600 measurement range (using 16-bit A/D)
Maximum sampling rate	1MS/s
Accuracy	DC amplitude: ±0.2% f.s. Zero-position: ±0.1% f.s.
Frequency characteristics	DC to 100kHz ±3dB. With AC coupling: 7Hz to 100kHz ±3dB
Input resistance and capacitance	1M Ω , 40pF (when C is 100kHz)
Input coupling	DC, GND, AC
Max. allowable input	400V DC (the maximum voltage that can be applied between input pins without causing damage)
Power terminal	DIFFERENTIAL PROBE 9322 Power (the POWER CORD 9328 is required for connection)
Anti-aliasing filter	Cutoff frequency (fc): 20Hz to 40kHz (set automatically) Attenuation: -66dB or greater at 1.5 fc

Dimensions and mass: approx. 104.7(4.1 in)W × 28(1.1 in)H × 164.5(6.5 in)D mm
approx. 160 g (5.6 oz) **Supplied accessories:** None



VOLTAGE/TEMP UNIT 8954 (Accuracy at 23 ±5°C (73 ±9°F) and 30 to 80% relative humidity when zero-adjust is performed after a 60-minute warm-up; accuracy guaranteed for 1 year)	
Measurement functions	Number of channels: 1 voltage or temperature measurement channel
Input	Voltage input: isolated BNC connector, thermocouple input: Plug-in terminal, Max. rated voltage to earth: 370V AC, DC (with input isolated from the unit, the maximum voltage that can be applied between input channels and chassis, or across input pins, without causing damage)
Voltage measurement range	500µV to 2V/DIV, 12 settings, full-scale = 20DIV, low-pass filter: 1Hz/5Hz/50Hz/500Hz, the measurement resolution: 1/1600 of range (using 16-bit AD)
Temperature measurement range	10°C, 100°C/DIV, 2 settings, full-scale = 20DIV, low-pass filter: 1Hz/5Hz/50Hz/500Hz, the measurement resolution: 1/1000 of range (using 16-bit AD)
Thermocouple range	K: -200 to 1350°C, E: -200 to 800°C, J: -200 to 1100°C, T: -200 to 400°C, N: -200 to 1300°C, R: 0 to 1700°C, S: 0 to 1700°C, B: 300 to 1800°C, W: 0 to 2000°C Reference junction compensation: internal/external (interchangeable)
Maximum sampling rate	Voltage input: 100kS/s, temperature measurement: 4kS/s (data updates every 250µs) Voltage input: DC amplitude: ±0.2% f.s. Zero-position: ±0.2% f.s. Temperature measurement (K, E, J, T, N): ±0.1% f.s. ±1°C, ±0.1% f.s. ±2°C (-200°C to 0°C), (R, S, W): ±0.1% f.s. ±3°C, (B): ±0.1% f.s. ±4°C (400 to 1800°C) Reference contact compensation accuracy: ±0.1% f.s. ±1.5°C (for reference junction internal compensation)
Accuracy	
Frequency characteristics	Voltage input: DC to 20kHz +1/-3dB Temperature measurement: DC to 1kHz +1/-3dB
Input resistance and capacitance	Voltage input: 1MΩ, 60pF (when C is 10kHz) Temperature measurement: 4.8MΩ or more
Max. allowable input	30V rms or 60V DC (the maximum voltage that can be applied between input pins without causing damage)

Cable length and mass: Main unit cable 1.5 m (4.92 ft), input section cable 30 cm (0.98 ft), approx. 150 g (5.3 oz)

Note: The unit-side plug of the 9320-01 and 9327 is different from the 9320.



LOGIC PROBE 9320-01/9327 (Accuracy at 23 ±5°C/73 ±9°F, 35 to 80% rh, accuracy guaranteed for 1 year)	
Function	Detection of voltage signal or relay contact signal for High/Low state recording
Input	4 channels (common ground between unit and channels), digital/contact input, switchable (contact input can detect open-collector signals), input impedance: 1MΩ (with digital input, 0 to +5V), 500kΩ or more (with digital input, +5 to +50V), pull-up resistance: 2kΩ (contact input: internally pulled up to +5V)
Digital input threshold	1.4V/2.5V/4.0V
Contact input detection resistance	1.5kΩ or higher (open) and 500Ω or lower (short), 3.5kΩ or higher (open) and 1.5kΩ or lower (short), 25kΩ or higher (open) and 8kΩ or lower (short)
Response speed	9320-01: 500ns or lower, 9327: detectable pulse width 100ns or higher
Max. allowable input	0 to +50V DC (the maximum voltage that can be applied across input pins without damage)

Cable length and mass: Main unit cable 1.5 m (4.92 ft), input section cable 1 m (3.28 ft), approx. 320 g (11.3 oz) Note: The unit-side plug of the 9321-01 is different from the 9321.



LOGIC PROBE 9321-01 (Accuracy at 23 ±5°C/73 ±9°F, 35 to 80% rh, accuracy guaranteed for 1 year)	
Function	Detection of AC or DC relay drive signal for High/Low state recording Can also be used for power line interruption detection
Input	4 channels (isolated between unit and channels), HIGH/LOW range switching Input impedance: 100kΩ or higher (HIGH range), 30kΩ or higher (LOW range)
Output (H) detection	170 to 250V AC, ±DC (70 to 250V) (HIGH range) 60 to 150V AC, ±DC (20 to 150V) (LOW range)
Output (L) detection	0 to 30V AC, ±DC (0 to 43V) (HIGH range) 0 to 10V AC, ±DC (0 to 15V) (LOW range)
Response time	Rising edge 1ms max., falling edge 3ms max. (with HIGH range at 200V DC, LOW range at 100V DC)
Maximum allowable input voltage	250Vrms (HIGH range), 150Vrms (LOW range) (the maximum voltage that can be applied across input pins without damage)

Cable length and mass: Main unit cable 1.3 m (4.27 ft), input section cable 46 cm (1.51 ft), approx. 350 g (12.3 oz)



DIFFERENTIAL PROBE 9322 (Accuracy at 23 ±5°C/73 ±9°F, 35 to 80% rh, after 30 minutes of warm-up time; accuracy guaranteed for 1 year)	
Function	For high-voltage floating measurement, power line surge noise detection, RMS rectified output measurement
DC mode	For waveform monitor output, frequency characteristics: DC to 10MHz (±3dB), amplitude accuracy: ±1% of full scale (at max. 1000V DC), ±3% of full scale (at max. 2000V DC) (full scale: 2000V DC)
AC mode	For detection of power line surge noise, frequency characteristics: 1kHz to 10MHz ±3dB
RMS mode	DC/AC voltage RMS output detection, frequency characteristics: DC, 40Hz to 100k Hz, response speed: 200ms or less (400V AC), accuracy: ±1% of full scale (DC, 40Hz to 1kHz), ±4% of full scale (1kHz to 100kHz) (full scale: 1000V AC)
Input	Input type: balanced differential input, input impedance/capacitance: H-L 9MΩ/10pF, H/L-unit 4.5MΩ/20pF, Max. rated voltage to earth: when using grabber clip 1500V AC/DC (CAT II), 600V AC/DC (CAT III), when using alligator clip: 1000V AC/DC (CAT II), 600V AC/DC (CAT III)
Maximum allowable input voltage	2000V DC, 1000V AC (CAT II), 600V AC/DC (CAT III)
Output	Voltage divider for 1/1000 of input, BNC connectors (output switchable for 3 modes DC, AC, RMS)
Power source	Power terminal of the input units, or use with AC ADAPTER 9418-15 (DC 12V)

Dimensions and mass: approx. 104.7(4.1 in)W × 28(1.1 in)H × 164.5(6.5 in)D mm
approx. 150 g (5.3 oz) **Supplied accessories:** None



F/V UNIT 8955 (Accuracy at 23 ±5°C (73 ±9°F) and 30 to 80% relative humidity when zero-adjust is performed after a 30-minute warm-up; accuracy guaranteed for 1 year)	
Measurement functions	Number of channels: 1, Measurements: frequency of voltage input, power frequency, revolution speed, integration, pulse duty comparison, pulse width
Input	Metal BNC connector, Max. rated voltage to earth: 30V rms or 60V DC (with input isolated from the unit, the maximum voltage that can be applied between input channels and chassis, or across input pins, without causing damage)
Measurement range	Frequency: 0.1Hz to 5kHz/DIV between DC to 100kHz, 10 settings Rotations: 10 (r/min) to 500 (r/min)/DIV, 4 settings Power frequency: 50Hz (40 to 60Hz), 60Hz (50 to 70Hz) Integration: 2 kcounts to 1Mcounts/DIV between DC to 90kHz Pulse duty ratio: 100% f.s. between 10Hz to 100kHz, 1 setting Pulse width: 500µs to 100ms/DIV between 2.5µs to 2sec, 6 settings Max. allowable input: 30V rms or 60V DC (the maximum voltage that can be applied between input pins without causing damage), full-scale = 20DIV, low-pass filter: 5Hz/500Hz/5kHz/100kHz/OFF
Measurement resolution	Frequency, power frequency, rotations, pulse width, duty ratio: 1/200 of measurement range Pulse duty ratio: 1/2000 of measurement range
Response time	10µs + 50ns or less (when frequency is less than 300Hz, measuring integration or pulse width) 50µs + 50ns or less (when frequency is less than 300Hz, measuring pulse duty ratio, rotation)
Accuracy	Frequency: ±0.1% f.s. (for settings other than 100kHz f.s.), ±0.7% f.s. (100kHz f.s. setting) Rotation: ±0.1% f.s. Power frequency: ±0.032Hz Pulse duty ratio: ±1% f.s. (10Hz to 10kHz), ±4% f.s. (10kHz to 100kHz) Pulse width: ±0.1% f.s.
Other functions	Input pull up resistance: ON/OFF (10kΩ connected to 5V) Threshold level: -10 to +10V variable, slope: rises and drops Level: High, Low, Hold ON/OFF
Other functions	DIFFERENTIAL PROBE 9322 Power (the POWER CORD 9328 is required for connection)

LAN COMMUNICATOR 9333



Distribution media	One CD-R
Operating environment	Computer equipped with Pentium (133 MHz) or better CPU, running under Windows 95/98/Me or Windows NT 4.0/ 2000/XP operating system, with network adapter installed and configured to use TCP/IP protocol, and at least 64 MB of memory.
HiCORDER side	Standard LAN connector
Communications	Ethernet, TCP/IP
Remote control	Remote control of MEMORY HiCORDER (by sending key codes and receiving images on screen), print reports, print images from the screen, receive waveform data in same format as waveform files from the MEMORY HiCORDER (binary only)
Waveform data acquisition	Accept auto-saves from the MEMORY HiCORDER, same format as auto-save files of MEMORY HiCORDER (binary only), print automatically with a MEMORY HiCORDER from a PC. The MEMORY HiCORDER's print key launches printouts on the PC
Waveform viewer	Simple display of waveform files, conversion to CSV format, Scroll function, enlarge/reduce display, display CH settings.

WAVE PROCESSOR 9335

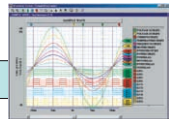

Distribution media	One CD-R
Operating environment	Computer equipped with Pentium (133 MHz) or better CPU and at least 32 MB of memory, and running under Windows 95/98/Me or Windows NT 4.0/2000/XP (recommended system: Pentium (200 MHz) or better with at least 64 MB of memory)
Display functions	Waveform display/X-Y display/digital value display/cursor function/scroll function/maximum number of channels (32 channels analog, 32 channels logic)/gauge display (time, voltage axes)/graphical display
File loading	Readable data formats (.MEM, .REC, .RMS, .POW) Maximum loadable file size: Maximum file size that can be saved by a given device (file size may be limited depending on the computer configuration)
Data conversion	Conversion to CSV format, tab delimited, space delimited/data culling (simple)/convert for specified channel/batch conversion of multiple files
Print functions	Print formatting (1 up, 2-to-16 up, 2-to-16 rows, X-Y 1-to-4 up) /preview/hard copy functions usable on any printer supported by operating system
Other	Parameter calculation/search/clipboard copy/launching of other applications

Measure Power Abnormalities During Power ON/OFF or Load Fluctuations

Introducing Power Monitoring Using the FUNCTION UP DISK 9549

Voltage, current, and power waveforms on the secondary side of an inverter

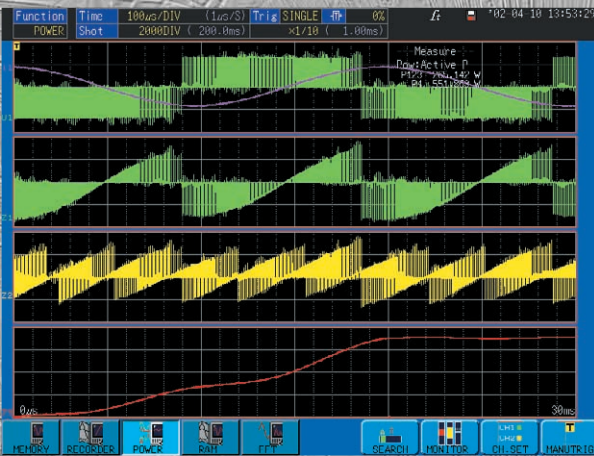

Display of power and other parameters (calculated)

Function	Time	3V3A			
		I1	I2	I3	1P2W
Voltase	Rms	200.361 V	200.712 V	201.836 V	182.021 V
	Mean	169.473 V	169.361 V	170.883 V	182.492 V
	Dc	-0.002 V	0.004 V	-0.332 V	0.004 V
	Max	350.300 V	354.600 V	386.200 V	133.500 V
	Min	-344.600 V	-355.800 V	-381.000 V	-138.500 V
	Freq.	4.55057kHz	4.56192kHz	5.5735kHz	60.0124 Hz
Current	Rms	6.1088 A	4.9719 A	6.6989 A	10.194 A
	Mean	6.1656 A	4.9674 A	6.7017 A	4.883 A
	Dc	0.4749 A	-0.2060 A	-0.1440 A	-0.293 A
	Max	9.6300 A	7.0000 A	10.9800 A	32.450 A
	Min	-8.7400 A	-7.6000 A	-11.3600 A	-32.300 A
	Freq.	147.531 Hz	160.983 Hz	299.798 Hz	457.875 Hz
Power Active P	P123	265.142 W			551.863 W
	Apparent S	2.0677kVA			1.0307kVA
	Reactive U	2.0507kvar			0.01610 var
	Factor	0.1282			0.5354
	Phase	62.63 °			57.63 °

By installing the power monitor function in the MEMORY HiRECORDER 8855, you can monitor power transient waveforms and view power trend graphs. Use of this function requires the optional FUNCTION UP DISK 9549, which is sold separately. Input units that can be used with this function are the ANALOG UNIT 8950 and the DC/RMS UNIT 8952. For current input, you can use either the VOLTAGE/CURRENT UNIT 8951, or the CLAMP ON PROBE 3273-50/3274/3275/3276. (The 9270 Series can also be used.)

Calculated power results for all acquired waveforms or the span selected with the A-B cursors can be displayed on the screen as a list. A full 4 channels are available for each of voltage and current, allowing measurement of one 3-phase, 3-wire system, or one single-phase, 2-wire system. Calculated results can be displayed either as numerics only (as shown above), or as a numeric overlay in a waveform screen like that shown at left.

Excess power during inverter power-on operation

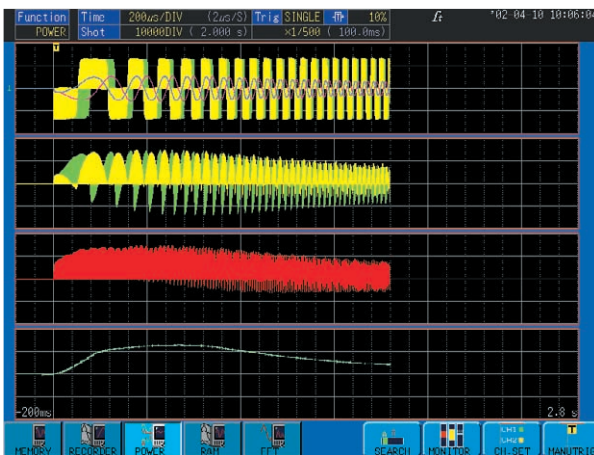

You can display a variety of waveforms accompanying inverter startup, including transient (excess) power waveforms and trend graphs (fluctuation waveforms). Together with its noise-resistant CMRR characteristic, the high floating voltage maintained by the 8855's isolated input assures stable observation of voltage waveforms. Observation of current is possible using the 8855 in combination with the appropriate voltage/current input unit and a clamp-on probe or clamp-on sensor. This makes it easy to measure power surges occurring when power is turned on that cannot be measured with ordinary power meters.

Power Measurement Settings Screen

Wiring	Waveform	Calc	Ch	F	Meas	Area	Graph	Cross	Slope	Filter
1 3V3A	Z1 INSTANTANEOUS	P1	GR2							
	Z2 INSTANTANEOUS	P123	GR3							
2	Z3 VARIABLE TREND	P123	GR4	I11						INVERTER
3	Z4	OFF								
	Z5	OFF								
	Z6	OFF								
4	Z7 1P2W	UI1								
	Z8	OFF								

CONNECTION	Scale	Lower	Upper
Z1	MANU	-3.0000k	3.0000k
Z2	MANU	-3.0000k	3.0000k
Z3	MANU	0.0000	300.00
Z4			
Z5			
Z6			
Z7			
Z8			

There is no need to set up complicated operations, such as calculations for waveform processing involving the memory function. All that is needed is to select the connect mode and a waveform type of either instantaneous or variable. A connection check function is provided to help you determine whether the connection method is correct.

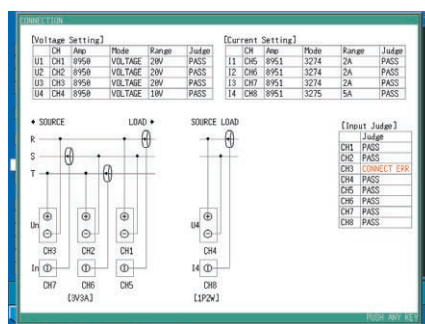

Power monitor function
(installed as an option)

This function works with the single-phase two-wire, single-phase three-wire, three-phase three-wire, three-phase four-wire and DC connection modes, making it possible to measure systems ranging from four single-phase two-wire systems, to a combination of one three-phase four wire system + one single-phase two-wire system. Calculations can be performed on partial waveforms selected for all waveforms in storage by using the A-B cursors, and results can be displayed in a single screen. Numeric results can be displayed as overlays in the waveform screens.

Instantaneous power waveform display
(power monitor function)

This function multiplies captured voltage and current waveforms and displays the result as an instantaneous power waveform. (Display in real-time is possible through hardware integration processing for speed ranges up to 10 ms/DIV. For faster ranges, power waveform display is calculated after first storing waveforms in memory.) Power waveform display allows up to 8 waveforms to be displayed in addition to voltage and current waveforms, and a total of up to 16 waveforms can be displayed simultaneously (8 voltage/current channels, and 8 power waveforms). Using the appropriate input units, values such as temperature and frequency can be simultaneously observed on channels for which power calculations are not being performed.

Trend graph display
(power monitor function)

Using this function, you can do calculations using voltage and current waveforms stored in memory, and display the results as voltage, current, or power trend graphs. This enables you to perform detailed analyses on the transient power segments, such as when a device is powered on or during load fluctuations.

Power monitor specifications and options

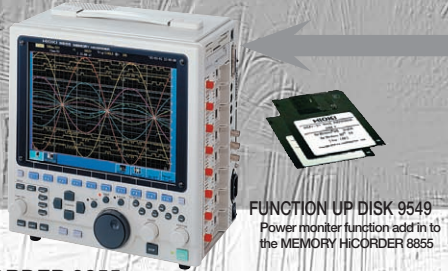

FUNCTION UP DISK 9549
Power monitor function add in to the MEMORY HiRECORDER 8855

MEMORY HiRECORDER 8855 (main unit + FUNCTION UP DISK 9549)

Sample configuration for use with single-phase 2-wire systems
(8855 + one each 9549, 8950, and 8951) + (one each 9197 and 3275)



Various input modules
User-installable in any combination by insertion into the instrument.
Note: Input cords are not provided. Please purchase the appropriate input cord for the probe type and application separately.

ANALOG UNIT 8950
VOLTAGE/CURRENT UNIT 8951
DC/RMS UNIT 8952
HIGH RESOLUTION UNIT 8953-10
Cannot be used for power calculations
VOLTAGE/TEMP UNIT 8954
Cannot be used for power calculations
F/V UNIT 8955
Cannot be used for power calculations

Power monitor function (optional, sold separately, for use with the 9549)

Measurement functions	Power monitor
Input modules that can be used	Voltage: ANALOG UNIT 8950, DC/RMS UNIT 8952 Current: VOLTAGE/CURRENT UNIT 8951 (can be used with a clamp-on probe)
Time axis	5µs to 5s/DIV (100 samples/DIV) 19 settings; external sampling (1 sample/DIV, desired setting); time axis zoom ×2 to ×10, 3 settings; compression 1/2 to 1/10,000, 12 settings
Sampling period	1/100 of time axis ranges (minimum sampling cycle of 50ns)
Recording length	Fixed setting: 30 to 10,000 DIV, 20,000* ¹ DIV, 50,000* ² DIV, 100,000* ² DIV Desired setting: 1 to 10,000 DIV (standard), 1 to 40,000* ¹ DIV, 1 to 160,000* ² DIV ¹ When using 128MW expanded memory, ² When using 512MW expanded memory, the maximum recording length depends on the number of channels being used.
Calculation accuracy	Using the CLAMP ON PROBE 3273-50, 3274, 3275, or 3276 : ±2.0% rdg.* ³ Using the UNIVERSAL CLAMP ON CT 9277, 9278, or 9279 : ±2.5% rdg.* ³ Using the CLAMP ON SENSOR 9270 or 9272 (20 A range) : ±3.5 % rdg.* ³ Using the CLAMP ON SENSOR 9271 or 9272 (200 A range) : ±2.0% rdg.* ³ ³ Input sine wave (50% f.s.), power factor = 1, 55Hz, single-phase 2-wire, calculation (11 waveforms), input coupling AC, filter: OFF; after offset adjustment has been performed for the clamp-on probe
Screen display	Storage waveform (analog, logic), waveform calculation, parameter value, cursor read value screen/print settings: 1, 2, 4, or 8 screens can be displayed
Other functions	Recording line settings (12 colors), overlay function, waveform scrolling, zoom function, logging function, variable display function, waveform judgment
Power value calculations	Calculation channels: max. 4 fixed probes, voltage channels 1 to 4, current channels 5 to 8 Numerical calculations: displays each voltage and current as a single block U rms : RMS voltage, I rms : RMS current, U mn : average voltage, I mn : average current, U dc : simple average voltage, I dc : simple average current, U pk± : peak voltage, I pk± : peak current, Uf : voltage frequency, If : current frequency, P : effective power, S : apparent power, Q : reactive power, λ : power factor, φ : phase Calculation area: All data stored in memory, area between the A and B cursors
Power waveform calculations	Calculation channels: max. 4 fixed probes, voltage channels 1 to 4, current channels 5 to 8 Display channels: displays a total of 16 channels on the screen, including 8 input waveform and 8 calculation waveform channels. Waveform calculation: instantaneous power waveforms (the time axis for the real-time display is 10ms/DIV slower), trend graph of effective power points that cross zero (after data storage is complete), trend graph of voltage/current (RMS value fluctuation) Calculation memory: With standard memory (32MW): up to 10,000 DIV regardless of the number of channels With 128MW expanded memory: up to 40,000 DIV regardless of the number of channels With 512MW expanded memory: up to 160,000 DIV regardless of the number of channels
Triggers	Trigger types: level, window in, window out, period, glitch, event, logic pattern (conforms to specifications for the 8855) Zero cross: search using software Zero cross filter: OFF, Narrow, Wide, Inverter

Voltage input for 100/200V systems

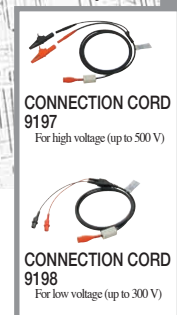

CONNECTION CORD 9197
For high voltage (up to 500 V)

CONNECTION CORD 9198
For low voltage (up to 300 V)

For Input Voltages Exceeding 280Vrms



DIFFERENTIAL PROBE 9322
For input up to 2 kV DC or 1 kV AC. Requires one POWER CORD 9328 for each probe.

POWER CORD 9328
Connects to the DIFFERENTIAL PROBE 9322 and the input unit.

For inputting current

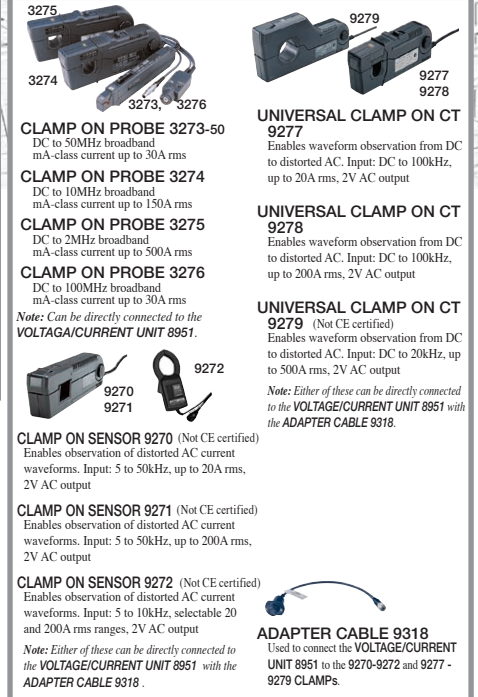

CLAMP ON PROBE 3273-50
DC to 50MHz broadband mA-class current up to 30A rms

CLAMP ON PROBE 3274
DC to 10MHz broadband mA-class current up to 150A rms

CLAMP ON PROBE 3275
DC to 2MHz broadband mA-class current up to 500A rms

CLAMP ON PROBE 3276
DC to 100MHz broadband mA-class current up to 30A rms

Note: Can be directly connected to the VOLTAGE/CURRENT UNIT 8951.

CLAMP ON SENSOR 9270 (Not CE certified)
Enables observation of distorted AC current waveforms. Input: 5 to 50kHz, up to 20A rms, 2V AC output

CLAMP ON SENSOR 9271 (Not CE certified)
Enables observation of distorted AC current waveforms. Input: 5 to 50kHz, up to 200A rms, 2V AC output

CLAMP ON SENSOR 9272 (Not CE certified)
Enables observation of distorted AC current waveforms. Input: 5 to 10kHz, selectable 20 and 200A rms ranges, 2V AC output

Note: Either of these can be directly connected to the VOLTAGE/CURRENT UNIT 8951 with the ADAPTER CABLE 9318.

UNIVERSAL CLAMP ON CT 9277
Enables waveform observation from DC to distorted AC. Input: DC to 100kHz, up to 20A rms, 2V AC output

UNIVERSAL CLAMP ON CT 9278
Enables waveform observation from DC to distorted AC. Input: DC to 100kHz, up to 500A rms, 2V AC output

UNIVERSAL CLAMP ON CT 9279 (Not CE certified)
Enables waveform observation from DC to distorted AC. Input: DC to 20kHz, up to 500A rms, 2V AC output

Note: Either of these can be directly connected to the VOLTAGE/CURRENT UNIT 8951 with the ADAPTER CABLE 9318.

ADAPTER CABLE 9318
Used to connect the VOLTAGE/CURRENT UNIT 8951 to the 9270-9272 and 9277-9279 CLAMPS.

Waveform recording lengths for power calculations
(When the optional recording length is set) The recording lengths are longer than when using the fixed recording length. The number of channels in use does not affect the recording length.

Time axis	Sampling period	With standard memory capacity (32 MW) Maximum recording length of 10,000 divisions	With standard memory capacity (128 MW) Maximum recording length of 40,000 divisions	With standard memory capacity (512 MW) Maximum recording length of 160,000 divisions
5µs/DIV	50ns		0.05s	0.2s
10µs/DIV	100ns		0.1s	0.4s
20µs/DIV	200ns		0.2s	0.8s
50µs/DIV	500ns		0.5s	2s
100µs/DIV	1µs		1s	4s
200µs/DIV	2µs		2s	8s
500µs/DIV	5µs		5s	20s
1ms/DIV	10µs		10s	40s
2ms/DIV	20µs		20s	80s
5ms/DIV	50µs		50s	200s
10ms/DIV	100µs	1m 40s	6m 40s	26m 40s
20ms/DIV	200µs	3m 20s	13m 20s	53m 20s
50ms/DIV	500µs	8m 20s	33m 20s	133m 20s
100ms/DIV	1ms	16m 40s	66m 40s	266m 40s
200ms/DIV	2ms	33m 20s	133m 20s	533m 20s
500ms/DIV	5ms	83m 20s	333m 20s	1333m 20s
1s/DIV	10ms	166m 40s	666m 40s	2666m 40s
2s/DIV	20ms	333m 20s	1333m 20s	5333m 20s
5s/DIV	50ms	833m 20s	3333m 20s	13333m 20s

Measurement amplifiers

Input modules

User-installable in any combination by insertion into the instrument.
Note: Input cords are not provided. Please purchase the appropriate input cord for the probe type and application separately.

ANALOG UNIT 8950
VOLTAGE/CURRENT UNIT 8951
DC/RMS UNIT 8952
HIGH RESOLUTION UNIT 8953-10
VOLTAGE/TEMPERATURE UNIT 8954
F/V UNIT 8955

Logical measurement

LOGIC PROBE 9327
4 channels, ON/OFF detection of voltage/contact signals (high-speed type for use with the 8855)

9321-01 LOGIC PROBE
4 isolated channels, ON/OFF detection of AC/DC voltage (miniature terminal for use with the 8855, 8807, and 8808)

ADAPTER CABLE 9323
(This is a terminal conversion cable for connecting the all-purpose 9321 logic probe and the 8855 when terminals do not match.)

Voltage measurement

CONNECTION CORD 9197
For high voltage (up to 500V)

DIFFERENTIAL PROBE 9322
For input up to 2 kV DC or 1 kV AC. Requires one POWER CORD 9328 for each probe.

CONNECTION CORD 9198
For low voltage (up to 300V)

POWER CORD 9328
Connects to the DIFFERENTIAL PROBE 9322 and the input unit.

10:1 PROBE 9665
Max. rated voltage to earth is the same as for the input unit. Max. input voltage: 1kV (up to 1MHz)

CONNECTION CORD 9217
Insulated BNC connectors at both ends, and connects to insulated BNC connectors

100:1 PROBE 9666
Max. rated voltage to earth is the same as for the input unit. Max. input voltage: 5kV peak (up to 1MHz)

CONNECTION CORD 9165
Metal BNC connectors at both ends, and connects to metal BNC connectors

CONVERSION ADAPTER 9199
Banana-to-BNC, use to connect to insulation-BNC terminal on Input section

MO UNIT 9646
Specify upon order, cannot be installed by user

MEMORY BOARD 9645 (128Mwords total)
Expands memory to 4 times standard size. Specify upon order, factory installation only.

MEMORY BOARD 9645-01 (512Mwords total)
Expands memory to 16 times standard size. Specify upon order, factory installation only.

HD UNIT 9663
Specify upon order, factory installation only. (20GB)
Note: The MO and HD units cannot be mounted on the unit at the same time.

MEMORY HiORDER 8855 (main unit)

Current measurement

CLAMP ON PROBE 3273-50
DC to 50MHz broadband mA-class current up to 30A rms

CLAMP ON PROBE 3274
DC to 10MHz broadband mA-class current up to 150A rms

CLAMP ON PROBE 3275
DC to 2MHz broadband mA-class current up to 500A rms

CLAMP ON PROBE 3276
DC to 100MHz broadband mA-class current up to 30A rms

Note: Can be directly connected to the VOLTAGE/CURRENT UNIT 8951.

UNIVERSAL CLAMP ON CT 9277
Enables waveform observation from DC to distorted AC. Input: DC to 100kHz, up to 20A rms, 2V AC output

UNIVERSAL CLAMP ON CT 9278
Enables waveform observation from DC to distorted AC. Input: DC to 100kHz, up to 200A rms, 2V AC output

UNIVERSAL CLAMP ON CT 9279 (Not CE certified)
Enables waveform observation from DC to distorted AC. Input: DC to 20kHz, up to 500A rms, 2V AC output

Note: Either of these can be directly connected to the VOLTAGE/CURRENT UNIT 8951 with the ADAPTER CABLE 9318.

CLAMP ON SENSOR 9270 (Not CE certified)
Enables observation of distorted AC current waveforms. Input: 5 to 50kHz, up to 20A rms, 2V AC output

CLAMP ON SENSOR 9271 (Not CE certified)
Enables observation of distorted AC current waveforms. Input: 5 to 50kHz, up to 200A rms, 2V AC output

CLAMP ON SENSOR 9272 (Not CE certified)
Enables observation of distorted AC current waveforms. Input: 5 to 10kHz, selectable 20 and 200A rms ranges, 2V AC output

ADAPTER CABLE 9318
Used to connect the VOLTAGE/CURRENT UNIT 8951 to the 9270-9272 and 9277-9279 CLAMPS.
Note: Either of these can be directly connected to the VOLTAGE/CURRENT UNIT 8951 with the ADAPTER CABLE 9318.

Printing

PRINTER UNIT 8994
Specify upon order, factory installation only.

RECORDING PAPER 9231
A4 width 216 mm (8.50 in) x 30 m (98.43 ft), 6 rolls set

PAPER WINDER 220H
Paper width 70mm (2.75 in) to 220mm (8.66 in), using special-purpose AC adapter
Not CE certified

Communication

RS-232C CARD 9557
PCMCIA-compliant

GP-IB CARD 9558
PCMCIA-compliant, cord length: 2m (6.6ft)

LAN CABLE 9642
Supplied with cross conversion cable, straight Ethernet cable, length: 5m (16.4ft)

LAN COMMUNICATOR 9333
Application software to create a LAN connection with Windows 95/98/Me, or Windows NT 4.0/2000/XP.

WAVE PROCESSOR 9335
Data conversion, print functions, waveform display, compatible with Windows 95/98/Me, Windows NT 4.0, and Windows 2000/XP.

PC CARD 128M 9726
(128 MB capacity)

PC CARD 256M 9727
(256 MB capacity)

PC CARD 512M 9728
(512 MB capacity)

PC CARD 1G 9729
(1 GB capacity)

PC Card Precaution
Use only PC Cards sold by HIOKI. Compatibility and performance are not guaranteed for PC cards made by other manufacturers. You may be unable to read from or save data to such cards.

FUNCTION UP DISK 9549 (POWER MONITOR)
Adds power monitor functions to the MEMORY HiORDER 8855.

CARRYING CASE 9397-01
With casters for easier transport.

■ **Combination example: 8855** (non printer, standard memory, normal choice of the input unit)

	Main unit	Memory 32MW	1ch	2ch	3ch	4ch	5ch	6ch	7ch	8ch
Model number x quantity	8855x1	standard	8950x1	8950x2	8950x3	8950x4	8950x5	8950x6	8950x7	8950x8
Input cable			9198x1	9198x2	9198x3	9198x4	9198x5	9198x6	9198x7	9198x8

■ **Combination example: 8855** (with printer, expands memory to 4 times standard size)

	Main unit	Memory 128MW	1ch	2ch	3ch	4ch	5ch	6ch	7ch	8ch
Model number x quantity	8855x1	9645x1	8950x1	8950x2	8950x3	8950x4	8950x5	8950x6	8950x7	8950x8
Input cable	PRINTER UNIT 8994x1		9198x1	9198x2	9198x3	9198x4	9198x5	9198x6	9198x7	9198x8



HIOKI E. E. CORPORATION

HEAD OFFICE :
 81 Koizumi, Ueda, Nagano, 386-1192, Japan
 TEL +81-268-28-0562 / FAX +81-268-28-0568
 E-mail: os-com@hioki.co.jp

HIOKI USA CORPORATION :
 6 Corporate Drive, Cranbury, NJ 08512 USA
 TEL +1-609-409-9109 / FAX +1-609-409-9108
 E-mail: hioki@hiokiusa.com

Shanghai Representative Office :
 1904, Shanghai Times Square Office
 93 Huaihai Zhong Road
 Shanghai, 200021, P.R.China
 TEL +86-21-6391-0090, 0092
 FAX +86-21-6391-0360
 E-mail: info@hioki.cn

DISTRIBUTED BY