



Frontier Electronics Corp.

667 E. COCHRAN STREET, SIMI VALLEY, CA 93065

TEL: (805) 522-9998 FAX: (805) 522-9989

E-mail: frontiersales@frontierusa.com

Web: <http://www.frontierusa.com>

1A FAST EFFICIENT RECTIFIER

FE10-005 THRU FE10-08

FEATURES

- LOW POWER LOSS, HIGH EFFICIENCY
- LOW LEAKAGE
- LOW FORWARD VOLTAGE DROP
- HIGH CURRENT CAPABILITY
- HIGH SPEED SWITCHING
- HIGH RELIABILITY
- HIGH CURRENT SURGE
- GLASS PASSIVATED CHIP JUNCTION

MECHANICAL DATA

- CASE: MOLDED PLASTIC, DO41, DIMENSIONS IN INCHES AND (MILLIMETERS)
- EPOXY: UL 94V-0 RATE FLAME RETARDANT
- LEAD: MIL-STD-202E METHOD 208C GUARANTEED
- MOUNTING POSITION: ANY
- WEIGHT: 0.34 GRAMS

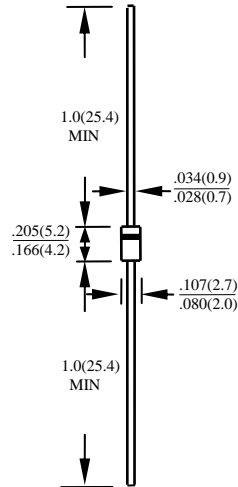

MAXIMUM RATINGS AND ELECTRICAL CHARACTERISTICS RATINGS AT 25°C AMBIENT TEMPERATURE UNLESS OTHERWISE SPECIFIED

RATINGS	SYMBOL	FE10-005	FE10-01	FE10-015	FE10-02	FE10-03	FE10-04	FE10-05	FE10-06	FE10-08	UNITS
MAXIMUM RECURRENT PEAK REVERSE VOLTAGE	V_{RRM}	50	100	150	200	300	400	500	600	800	V
MAXIMUM RMS VOLTAGE	V_{RMS}	35	70	105	140	210	280	350	420	560	V
MAXIMUM DC BLOCKING VOLTAGE	V_{DC}	50	100	150	200	300	400	500	600	800	V
MAXIMUM AVERAGE FORWARD RECTIFIED CURRENT 0.375"(9.5mm) LEAD LENGTH AT $T_A=55^\circ\text{C}$	I_O	1.0									A
PEAK FORWARD SURGE CURRENT, 8.3ms SINGLE HALF SINE-WAVE SUPERIMPOSED ON RATED LOAD	I_{FSM}	30									A
TYPICAL JUNCTION CAPACITANCE (NOTE 1)	C_J	70									PF
TYPICAL THERMAL RESISTANCE (NOTE 2)	$R_{\theta ja}$	50									$^\circ\text{C}/\text{W}$
STORAGE TEMPERATURE RANGE	T_{STG}	- 55 TO + 150									$^\circ\text{C}$
OPERATING TEMPERATURE RANGE	T_{OP}	- 55 TO + 150									$^\circ\text{C}$

ELECTRICAL CHARACTERISTICS (At $T_A=25^\circ\text{C}$ UNLESS OTHERWISE NOTED)

CHARACTERISTICS	SYMBOL	FE10-005	FE10-01	FE10-015	FE10-02	FE10-03	FE10-04	FE10-05	FE10-06	FE10-08	UNITS
MAXIMUM FORWARD VOLTAGE AT I_O DC	V_F	0.98			1.25		1.85		2.60		V
MAXIMUM REVERSE CURRENT AT 25°C	I_R	10									μA
MAXIMUM REVERSE CURRENT AT 100°C	I_R	50									μA
MAXIMUM REVERSE RECOVERY TIME (NOTE 3)	T_{RR}	25									nS

SINGLE PHASE, HALF WAVE, 60 HZ, RESISTIVE OR INDUCTIVE LOAD. FOR CAPACITIVE LOAD, DERATE CURRENT BY 20%

NOTE: 1. MEASURED AT 1 MHZ AND APPLIED REVERSE VOLTAGE OF 4.0 VOLTS

2. BOTH LEADS ATTACHED TO HEAT SINK 20x20x1t(mm) COPPER PLATE AT LEAD LENGTH 5mm

3. REVERSE RECOVERY TEST CONDITIONS: $I_F=0.5\text{A}$, $I_R=1.0\text{A}$, $I_{RR}=0.25\text{A}$

RATINGS AND CHARACTERISTIC CURVE FE10-005 THRU FE10-08

FIG. 1-TEST CIRCUIT DIAGRAM AND REVERSE RECOVERY TIME CHARACTERISTIC

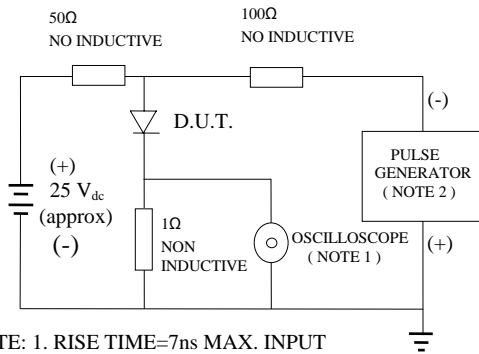

NOTE: 1. RISE TIME=7ns MAX. INPUT IMPEDANCE=1 MOhms 22PF
 2. RISE TIME =10ns MAX. SOURCE IMPEDANCE=50 OHMS

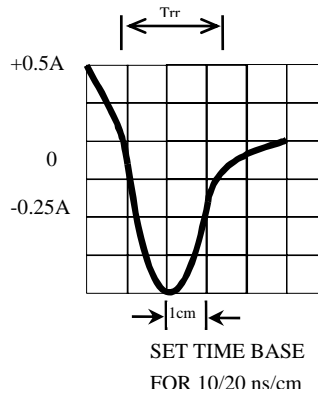

FIG. 2-TYPICAL FORWARD CURRENT DERATING CURVE

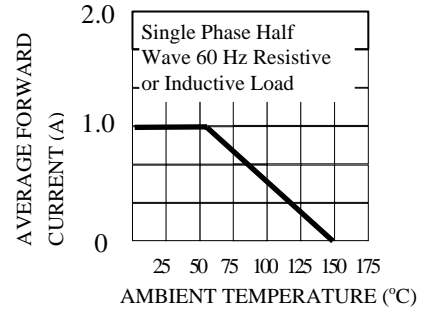

FIG. 3-TYPICAL REVERSE CHARACTERISTICS

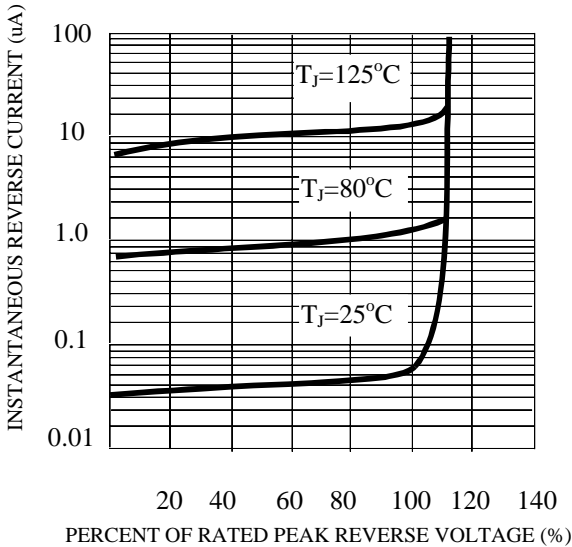

FIG. 4-TYPICAL INSTANTANEOUS FORWARD CHARACTERISTICS

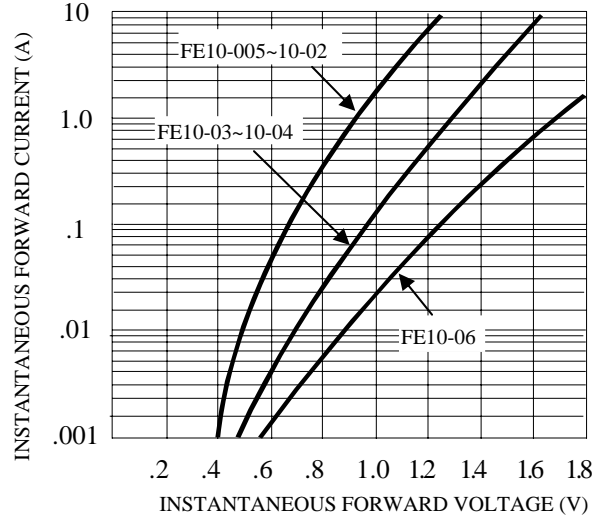

FIG. 5-MAXIMUM NON-REPETITIVE FORWARD SURGE CURRENT

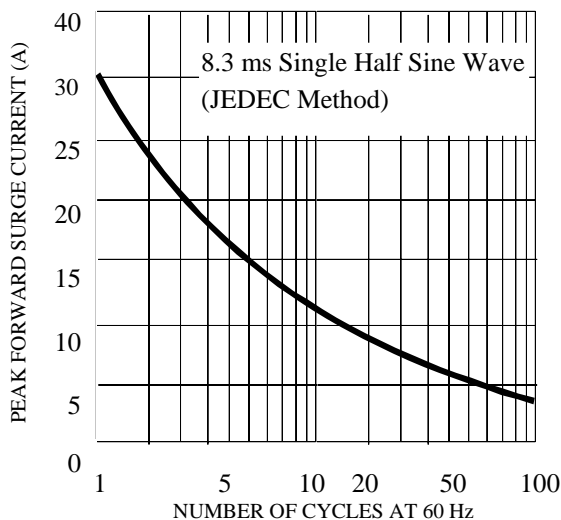

FIG. 6-TYPICAL JUNCTION CAPACITANCE

