

# SMDCx-3500



## Rectifier Diode



Type	$V_{RSM}$	$V_{RRM}$
SMDC1-3500	700-1700	600-1600
SMDC2-3500	900-2300	1600-2200
SMDC3-3500	2500-3700	2400-3600

Type	$I_{FAVM}$ $T_c=55^\circ\text{C}$	$I_{FRMS}$	$I_{FSM}$	$I_{RRM}$	$i^2t$	$V_{FM}$	$I_{FM}$	$V_{FO}$	$r_F$	$T_{VJM}$	$R_{thJC}$	F
	A	A	kA	mA	$\text{kA}^2\text{s}$	V	A	V	$\text{m}\Omega$	$^\circ\text{C}$	K/W	kN
SMDCx-3500	3500	6800	35	200	6110	2.0	5000	0.90	0.11	150	0.009	47

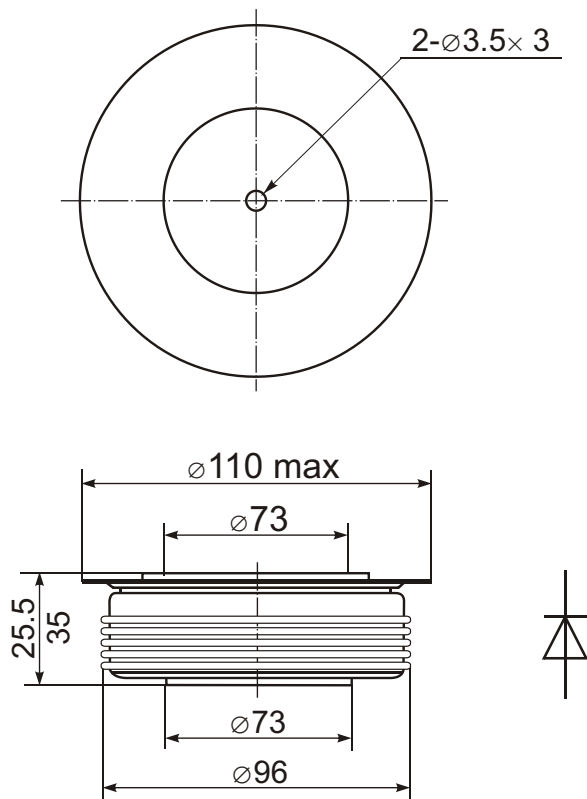

### Features:

- Hermetic metal case with ceramic insulator
- Capsule packages for double sided cooling
- International standard case

### Typical Applications:

- DC motor control
- AC motor soft starter
- Charging equipment