

### 1. PART NO. EXPRESSION :

W 1 2 2 5 F - 7 2 2 J  
 (a) (b) (c) (d) (e)

(a) Series Code

(b) Dimension Code

(C) RoHS Compliant

(d) Inductance code : 722 = 7200uH

(e) Tolerance code : J = ±5%

### 2. CONFIGURATION & DIMENSIONS :

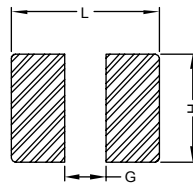
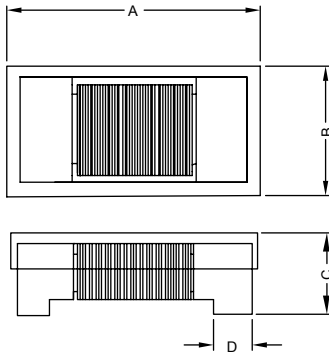

Recommend PC Board Pattern

Unit:mm

A	B	C	D	L	G	H
11.6±0.3	3.8±0.3	2.5±0.3	1.5 Ref.	11.6 Ref.	8.0 Ref.	3.6 Ref.

### 3. MATERIALS :

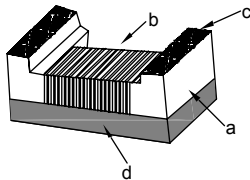

(a) Core : Ferrite

(b) Wire : Copper Wire

(c) Terminal : Tin (Pb free)

(d) Adhesive : UV or Epoxy

### 4. GENERAL SPECIFICATION :

- a) Test frequency : Inductor(L) : 10KHz /0.1V;
- b) All test data referenced to 25° C ambient.
- c) Operating Temperature : -40~+125° C
- d) Storage Temperature (on board) : -40~+125° C
- e) Irms will cause the coil temperature rise approximately Δt of 20°C.
- f) The part temperature (ambient + temp rise) should not exceed 85° C under worst case operating conditions.



**RoHS Compliant**

NOTE : Specifications subject to change without notice. Please check our website for latest information.



### 5. ELECTRICAL CHARACTERISTICS :

Part Number	Inductance (uH) $\pm$ 5%	Test Frequency (kHz)	SRF (KHz) Min.	RDC ( $\Omega$ ) Max.	Rated current (mA) Max.
W1225F-492J	4900	125	340	50	50
W1225F-722J	7200	125	300	50	40



**RoHS Compliant**

NOTE : Specifications subject to change without notice. Please check our website for latest information.

07.10.2014



**SUPERWORLD ELECTRONICS (S) PTE LTD**

PG. 2

6. CHARACTERISTICS CURVES :

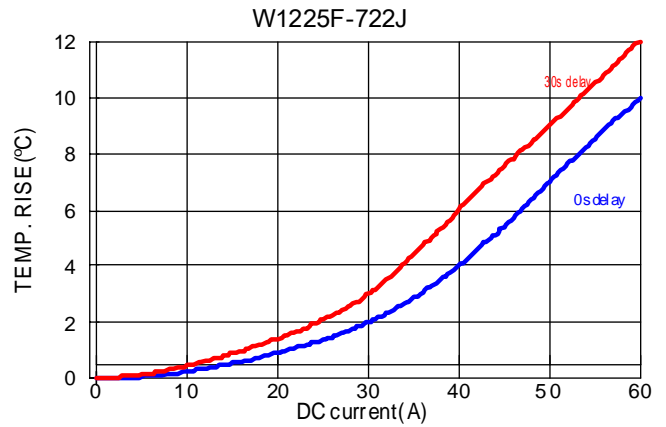
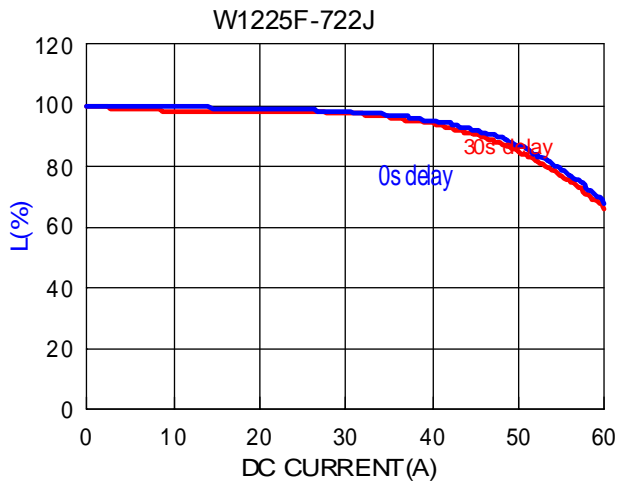
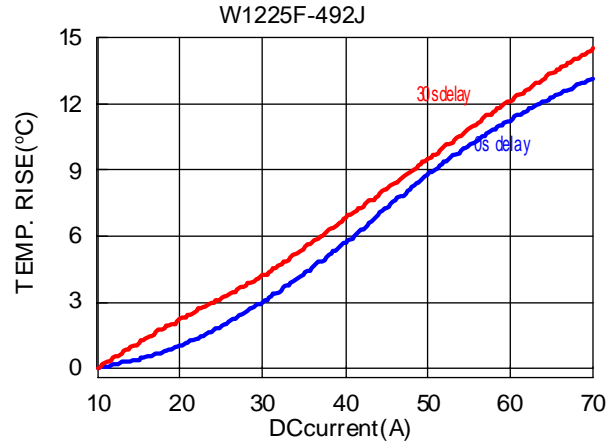
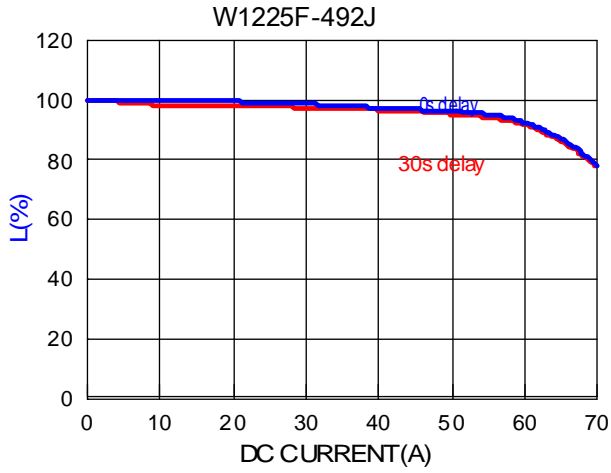

RoHS Compliant

NOTE : Specifications subject to change without notice. Please check our website for latest information.

07.10.2014



### 7. RELIABILITY AND TEST CONDITION :

ITEM	PERFORMANCE	TEST CONDITION								
Electrical Characteristics Test										
Inductance L	Refer to standard electrical characteristics list	Agilent-4192A, Agilent-16334A								
SRF		Agilent-4291B								
DCR		Agilent-34420A								
Temperature Rise Test	Rated Current < 1A ΔT 20°C Max Rated Current ≅ 1A ΔT 40°C Max	1. Applied the allowed DC current for 1 mins. 2. Temperature measured by digital surface thermometer								
Mechanical Performance Test										
Solderability Test	More than 95% of terminal electrode should be covered with solder.	Preheat : 150° C,60sec. Solder : Sn99.5%-Cu0.5% Temperature : 245±5° C Flux for lead free : Rosin.9.5% Dip time : 4±1sec Depth : completely cover the termination								
Solder Heat Resistance	Appearance : No damage. Inductance: within±10% of initial value RDC : within ± 15% of initial value and shall not exceed the specification value	<table border="1"> <thead> <tr> <th>Temperature (° C)</th> <th>Times (s)</th> <th>Temperature ramp/immersion and emersion rate</th> <th>Number of heat cycles</th> </tr> </thead> <tbody> <tr> <td>260±5 (solder temp)</td> <td>10±1</td> <td>25mm/s ± 6 mm/s</td> <td>1</td> </tr> </tbody> </table>	Temperature (° C)	Times (s)	Temperature ramp/immersion and emersion rate	Number of heat cycles	260±5 (solder temp)	10±1	25mm/s ± 6 mm/s	1
		Temperature (° C)	Times (s)	Temperature ramp/immersion and emersion rate	Number of heat cycles					
260±5 (solder temp)	10±1	25mm/s ± 6 mm/s	1							
Depth : completely cover the termination										



**RoHS Compliant**

NOTE : Specifications subject to change without notice. Please check our website for latest information.

07.10.2014



**SUPERWORLD ELECTRONICS (S) PTE LTD**

7. RELIABILITY AND TEST CONDITION :

Reliability Test		
Life Test	Appearance : No damage. Inductance: within±10% of initial value RDC : within ± 15% of initial value and shall not exceed the specification value	Preconditioning : Run through IR reflow for 2 times.(IPC/JEDEC J-STD-020DCclassification Reflow Profiles Temperature : 125± 2° C(Bead) Temperature : 85± 2° C(Inductor) Applied current : rated current Duration : 1000± 12hrs Measured at room temperature after placing for 24± 2 hrs
Thermal shock		Preconditioning : Run through IR reflow for 2 times.(IPC/JEDEC J-STD-020DCclassification Reflow Profiles Step1 : -40± 2° C 30± 5min Step2 : 25± 2° C ≅ 0.5min Step3 : 105± 2° C 30± 5min Number of cycles : 500 Measured at room fempraturc after placing for 24± 2 hrs
Humidity Resistance Test		Preconditioning : Run through IR reflow for 2 times.(IPC/JEDEC J-STD-020DCclassification Reflow Profiles Humidity : 85± 2% R.H, Temperature : 85° C± 2° C Duration : 1000hrs Min. with 100% rated current Measured at room temperature after placing for 24± 2 hrs
Vibration Test		Preconditioning : Run through IR reflow for 2 times.(IPC/JEDEC J-STD-020DCclassification Reflow Profiles Oscillation Frequency : 10~ 2K~ 10Hz for 20 minutes Equipment : Vibration checker Total Amplitude : 1.52mm± 10% Testing Time : 12 hours(20 minutes, 12 cycles each of 3 orientations)
Drop experiment	Product appearance is not damaged and the product does not fall off.  	Product welded on the PCB. PCB mounted inside the box. Easily from any direction at 100cm falling to the ground, falling 10 times repeated.



RoHS Compliant

NOTE : Specifications subject to change without notice. Please check our website for latest information.

07.10.2014



SUPERWORLD ELECTRONICS (S) PTE LTD

8. SOLDERING AND MOUNTING :

8-1. Attention regarding P.C.B. bending :

The following shall be considered when designing and laying out P.C.B.'S

(1)P.C.B. shall be designed so that products are not subjected to the mechanical stress for board warpage.

<Products direction>

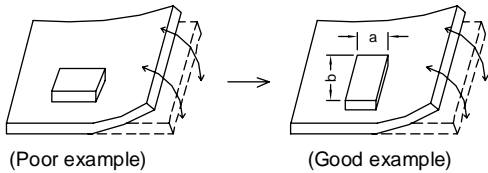

Products shall be located in the sideways direction (Length:a<b) to against the mechanical stress.

(2) Products location on P.C.B

Products (A,B,C,D) shall be located carefully to prevent mechanical stress when warping the board. Products may be subjected to the mechanical stress in the order of A>C>B=D.

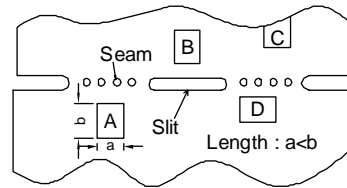

8-2. Soldering

Mildly activated rosin fluxes are preferred. Our terminations are suitable for all wave and re-flow soldering systems. If hand soldering cannot be avoided, the preferred technique is the utilization of hot air soldering tools.

8-2.1 Solder Re-flow :

Recommended temperature profiles for re-flow soldering in Figure 1.

8-2.2 Soldering Iron (Figure 2) :

Products attachment with a soldering iron is discouraged due to the inherent process control limitations. In the event that a soldering iron must be employed the following precautions are recommended.

Note :

- a) Preheat circuit and products to 150°C
- b) 355°C tip temperature (max)
- c) Never contact the ceramic with the iron tip
- d) 1.0mm tip diameter (max)
- e) Use a 20 watt soldering iron with tip diameter of 1.0mm
- f) Limit soldering time to 4-5 sec.

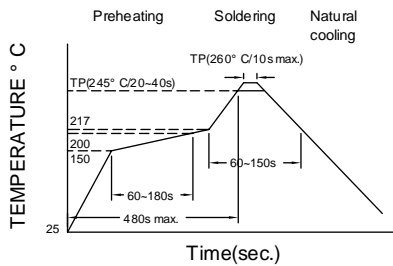

Figure 1. Re-flow Soldering: 3 times max.

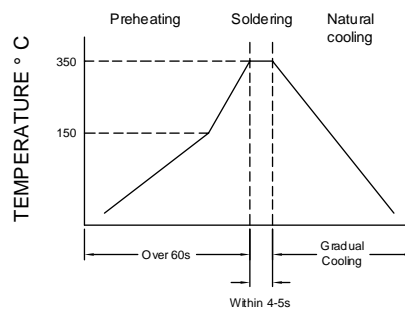

Figure 2. Iron Soldering times : 1 times max.



RoHS Compliant

NOTE : Specifications subject to change without notice. Please check our website for latest information.



## 9. PACKAGING INFORMATION :

### 9-1. Reel Dimension

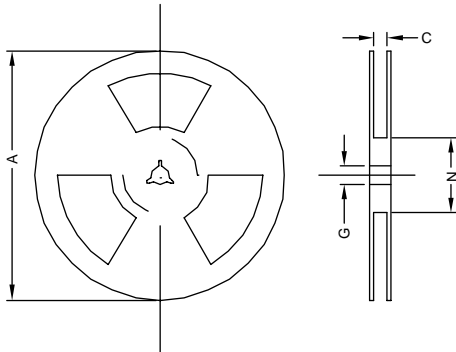

Type	A(mm)	C(mm)	G(mm)	N(mm)
13"x24mm	330±3	24.0±0.5	13.5±0.5	100±2

### 9-2 Tape Dimension / 12mm

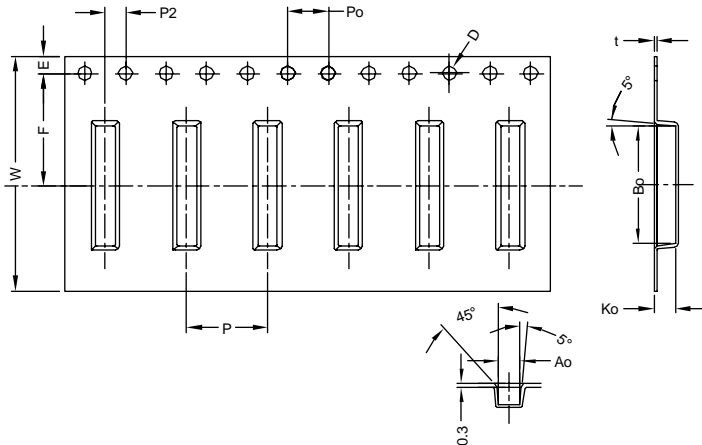

Series	P(mm)	Po(mm)	P2(mm)	Bo(mm)	Ao(mm)	Ko(mm)	t(mm)	D(mm)	E(mm)	F(mm)	W(mm)
W1225	8.0±0.1	4.0±0.1	2.0±0.1	12.05±0.1	4.2±0.1	2.65±0.1	0.3±0.05	1.5±0.1	1.75±0.1	11.5±0.1	24±0.3

### 9-3. Reel Dimension

Chip size	W1225
Reel	1000
Reel Size	13"x24mm



**RoHS Compliant**

NOTE : Specifications subject to change without notice. Please check our website for latest information.

07.10.2014



**SUPERWORLD ELECTRONICS (S) PTE LTD**

### 9-4. Tearing Off Force

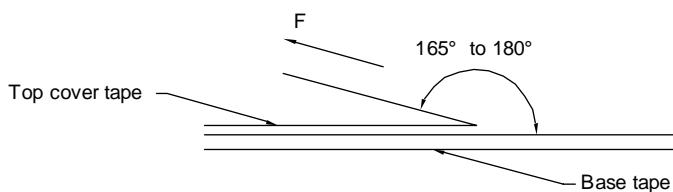

The force for tearing off cover tape is 10 to 80 grams in the arrow direction under the following conditions. (referenced ANSI/EIA-481-C-2003 of 4.11 standard)

Room Temp. (° C)	Room Humidity (%)	Room atm (hPa)	Tearing Speed (mm/min)
5-35	45-85	860-1060	300

### Application Notice

#### 1. Storage Conditions :

To maintain the solderability of terminal electrodes :

- a) Temperature and humidity conditions : Less than 40° C and 60% RH.
- b) Recommended products should be used within 12 months from the time of delivery.
- c) The packaging material should be kept where no chlorine or sulfur exists in the air.

#### 2. Transportation :

- a) Products should be handled with care to avoid damage or contamination from perspiration and skin oils.
- b) The use of tweezers or vacuum pick up is strongly recommended for individual components.
- c) Bulk handling should ensure that abrasion and mechanical shock are minimized.



**RoHS Compliant**

NOTE : Specifications subject to change without notice. Please check our website for latest information.

07.10.2014



**SUPERWORLD ELECTRONICS (S) PTE LTD**

PG. 8