

Two PLL Programmable Clock Generator with Spread Spectrum

Features

- Two fully integrated phase locked loops (PLLs)
 - External crystal: 8 to 48 MHz
 - External reference: 8 to 166 MHz clock
- Reference clock input voltage range
 - 2.5 V, 3.0 V, and 3.3 V for CY25482
 - 1.8 V for CY25402 and CY25422
- Wide operating output frequency range
 - 3 to 166 MHz
- Programmable spread spectrum with center and down spread option and lexmark and linear modulation profiles
- V_{DD} supply voltage options:
 - 2.5 V, 3.0 V, and 3.3 V for CY25402 and CY25482
 - 1.8 V for CY25422
- Selectable output clock voltages independent of V_{DD} :
 - 2.5 V, 3.0 V, and 3.3 V for CY25402 and CY25482
 - 1.8 V for CY25422
- Frequency select feature with option to select four different frequencies
- Power-down, Output Enable, and SS ON/OFF controls
- Low jitter, high accuracy outputs

- Ability to synthesize nonstandard frequencies with Fractional-N capability
- Three clock outputs with programmable drive strength
- Glitch-free outputs while frequency switching
- 8-pin small outline integrated circuit (SOIC) package
- Commercial and Industrial temperature ranges

Benefits

- Multiple high performance PLLs allow synthesis of unrelated frequencies
- Nonvolatile programming for personalization of PLL frequencies, spread spectrum characteristics, drive strength, crystal load capacitance, and output frequencies
- Application specific programmable EMI reduction using spread spectrum for clocks
- Programmable PLLs for system frequency margin tests
- Meets critical timing requirements in complex system designs
- Suitability for PC, consumer, portable, and networking applications
- Capable of zero parts per million (PPM) frequency synthesis error
- Uninterrupted system operation during clock frequency switch
- Application compatibility in standard and low power systems

Block Diagram

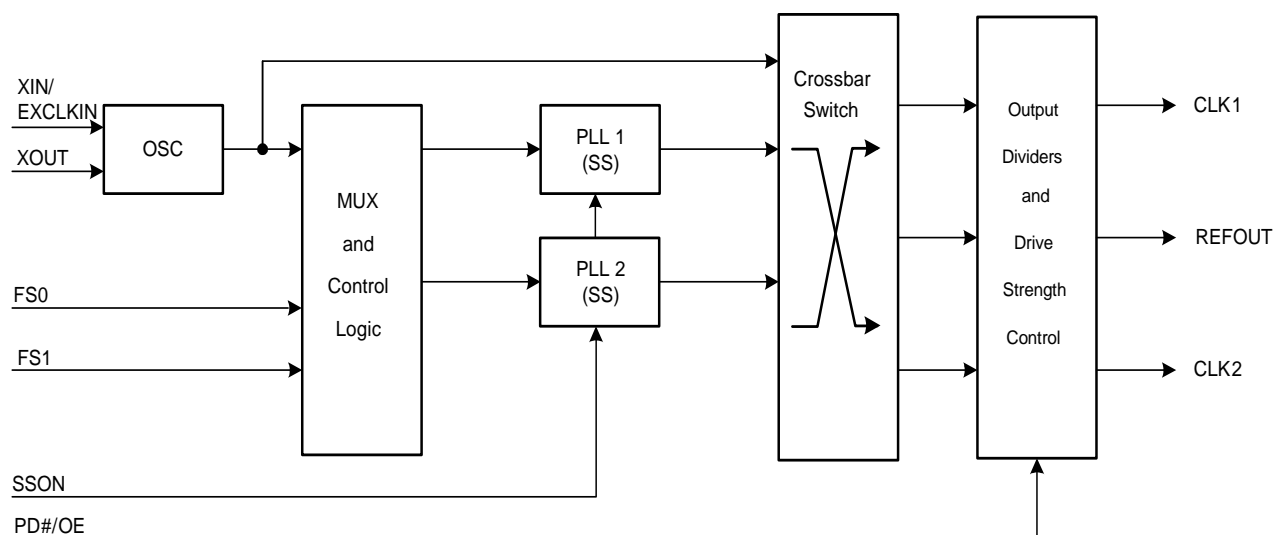

Contents

Pin Description	3	Recommended Crystal Specification for SMD Package	8
General Description	5	Test and Measurement Setup	9
2 Configurable PLLs	5	Voltage and Timing Definitions	9
Input Reference Clocks	5	Recommended Crystal Specification for	
VDD Power Supply Options	5	Thru-Hole Package	9
Output Source Selection	5	Possible Configurations	10
Spread Spectrum Control	5	Ordering Code Definitions	11
Frequency Select	5	Package Drawing and Dimensions	11
Glitch-Free Frequency Switch	5	Acronyms	12
PD#/OE Mode	5	Document Conventions	12
Output Drive Strength	5	Units of Measure	12
Generic Configuration and Custom Frequency	5	Document History Page	13
Absolute Maximum Conditions	6	Sales, Solutions, and Legal Information	14
Recommended Operating Conditions	6	Worldwide Sales and Design Support	14
DC Electrical Specifications	7	Products	14
AC Electrical Specifications	8	PSoC® Solutions	14

Table 1. Device Selector Guide

Device	Crystal Input	EXCKLKIN Input	V _{DD}
CY25402	Yes	1.8 V LVCMOS	2.5 V, 3.0 V, 3.3 V
CY25482	No	2.5 V, 3.0 V, 3.3 V LVCMOS	2.5 V, 3.0 V, 3.3 V
CY25422	Yes	1.8 V LVCMOS	1.8 V

Pin Description

Figure 1. Pin Diagram - CY25402 8-LD SOIC

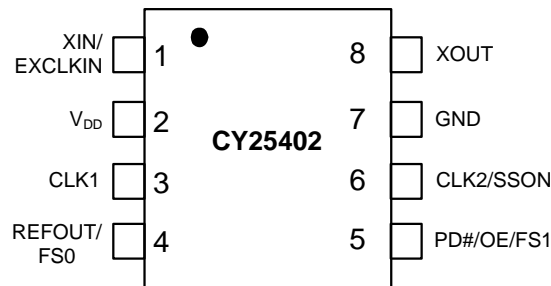

Table 2. Pin Definition - CY25402 (2.5 V, 3.0 V, or 3.3 V Supply)

Pin Number	Name	IO	Description
1	XIN/EXCLKIN	Input	Crystal input or 1.8 V External clock input
2	V _{DD}	Power	Power supply: 2.5 V, 3.0 V, or 3.3 V
3	CLK1	Output	Programmable clock output with spread spectrum
4	REFOUT/FS0	Output/input	Multifunction programmable pin: Reference clock output or frequency select pin
5	PD#/OE/FS1	Input	Multifunction programmable pin: Power-down, output enable or Frequency select pin
6	CLK2/SSON	Output/input	Multifunction programmable pin: Programmable clock output with spread spectrum or Spread spectrum ON/OFF control pin
7	GND	Power	Power supply ground
8	XOUT	Output	Crystal output

Figure 2. Pin Diagram - CY25482 8-LD SOIC

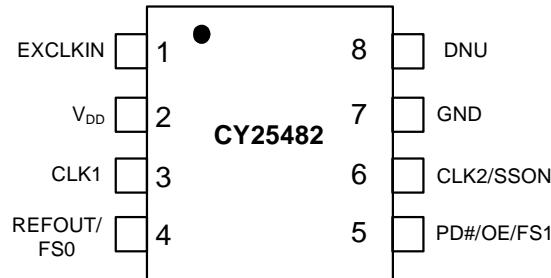

Table 3. Pin Definition - CY25482 (2.5 V, 3.0 V, or 3.3 V Supply)

Pin Number	Name	IO	Description
1	EXCLKIN	Input	2.5 V, 3.0 V, or 3.3 V external clock input
2	V _{DD}	Power	Power Supply: 2.5 V, 3.0 V, or 3.3 V
3	CLK1	Output	Programmable clock output with spread spectrum
4	REFOUT/FS0	Output/input	Multifunction programmable pin: Reference clock output or frequency select pin
5	PD#/OE/FS1	Input	Multifunction programmable pin: Power-down, output enable or frequency select pin
6	CLK2/SSON	Output/input	Multifunction Programmable pin: Programmable clock output with spread spectrum or spread spectrum ON/OFF control pin
7	GND	Power	Power supply ground
8	DNU	Output	Do not use this pin

Figure 3. Pin Diagram - CY25422 8-LD SOIC

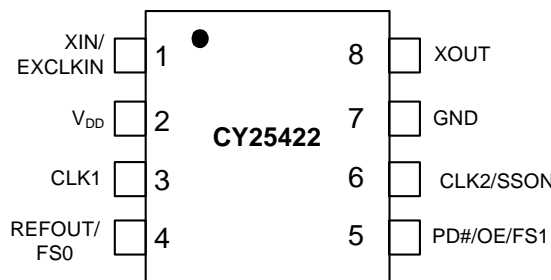

Table 4. Pin Definition - CY25422 (1.8 V Supply)

Pin Number	Name	IO	Description
1	XIN/EXCLKIN	Input	Crystal input or 1.8 V external clock input
2	V _{DD}	Power	Power supply: 1.8 V
3	CLK1	Output	Programmable clock output with spread spectrum
4	REFOUT/FS0	Output/input	Multifunction programmable pin: reference clock output or frequency select pin
5	PD#/OE/FS1	Input	Multifunction programmable pin: power-down, output enable or frequency select pin
6	CLK2/SSON	Output/input	Multifunction programmable pin: programmable clock output with spread spectrum or spread spectrum ON/OFF control pin
7	GND	Power	Power supply ground
8	XOUT	Output	Crystal output

General Description

2 Configurable PLLs

The CY25402, CY25422, and CY25482 have two programmable PLLs that can be used to generate output frequencies ranging from 3 to 166 MHz. The advantage of having two PLLs is that a single device generates two independent frequencies from a single crystal.

Input Reference Clocks

The input reference clock can be either a crystal or a clock signal, for CY25402 and CY25422 while just a clock signal for CY25482. The input frequency range for crystal (XIN) is 8 MHz to 48 MHz and that for external reference clock (EXCLKIN) is 8 MHz to 166 MHz. The voltage range of the reference clock input for CY25482 is 2.5 V/3.0 V/3.3 V while that for CY25402 and CY25422 is 1.8 V. This gives user an option for this device to be compatible for different input clock voltage levels in the system.

V_{DD} Power Supply Options

These devices have programmable power supply options. The CY25402/CY25482 is a high voltage part that can be programmed to operate at any voltage 2.5 V, 3.0 V, or 3.3 V while CY25422 is a low voltage part that can operate at 1.8 V.

Output Source Selection

These devices have programmable input sources for each of its clock outputs. There are three available clock sources and these clock sources are: XIN/EXCLKIN, PLL1, and PLL2. Output clock source selection is done by using three out of three crossbar switch. Thus, any one of these three available clock sources can be arbitrarily selected for the clock outputs. This gives user a flexibility to have two independent clock outputs.

Spread Spectrum Control

Both PLLs (PLL1 and PLL2) have spread spectrum capability for EMI reduction in the system. The device uses a Cypress proprietary PLL and spread spectrum clock (SSC) technology to synthesize and modulate the frequency of the PLL. The spread spectrum feature can be turned on or off using a multifunction control pin (CLK2/SSON). It can be programmed to either center spread range from $\pm 0.125\%$ to $\pm 2.50\%$ or down spread range from -0.25% to -5.0% with lexmark or linear profile.

Frequency Select

Each PLL can be programmed for up to four different frequencies. There are two multifunction programmable pins, REFOUT/FS0 and PD#/OE/FS1 which if programmed as frequency select inputs, can be used to select among these arbitrarily programmed frequency settings. Each output has programmable output divider options.

Glitch-Free Frequency Switch

When the frequency select pin, FS(1:0) is used to switch frequency, the outputs are glitch-free provided frequency is switched using output dividers. This feature enables uninterrupted system operation while clock frequency is being switched.

PD#/OE Mode

Multifunction pin PD#/OE/FS1 (Pin 5) can be programmed to operate as either frequency select (FS1), power down (PD#) or output enable (OE) mode. PD# is a low-true input. If activated it shuts off the entire chip, resulting in minimum power consumption for the device. Setting this signal high brings the device in the operational mode with default register settings.

When this pin is programmed as Output Enable (OE), clock outputs can be enabled or disabled using OE (pin 5). Individual clock outputs can be programmed to be sensitive to this OE pin.

Output Drive Strength

The DC drive strength of the individual clock output can be programmed for different values. Table 4 on page 4 shows the typical rise and fall times for different drive strength settings.

Table 5. Output Drive Strength

Output Drive Strength	Rise/Fall Time (ns) (Typical Value)
Low	6.8
Mid Low	3.4
Mid High	2.0
High	1.0

Generic Configuration and Custom Frequency

There is a generic set of output frequencies available from the factory that can be used for the device evaluation purposes. The devices, CY25402, CY25422, and CY25482 can be custom programmed to any desired frequencies and listed features. For customer specific programming, please contact local Cypress field application engineer (FAE) or sales representative.

Absolute Maximum Conditions

Parameter	Description	Condition	Min	Max	Unit
V _{DD}	Supply voltage for CY25402/CY25482	–	–0.5	4.5	V
V _{DD}	Supply voltage for CY25422	–	–0.5	2.6	V
V _{IN}	Input voltage for CY25402/CY25482	Relative to V _{SS}	–0.5	V _{DD} +0.5	V
V _{IN}	Input voltage for CY25422	Relative to V _{SS}	–0.5	2.2	V
T _S	Temperature, Storage	Non Functional	–65	+150	°C
ESD _{HBM}	ESD protection (human body model)	JEDEC EIA/JESD22-A114-E	2000	–	V
UL-94	Flammability rating	V-0 at 1/8 in.	–	10	ppm
MSL	Moisture sensitivity level	SOIC package	3		

Recommended Operating Conditions

Parameter	Description	Min	Typ	Max	Unit
V _{DD}	V _{DD} Operating voltage for CY25402/CY25482	2.25	–	3.60	V
V _{DD}	V _{DD} Operating voltage for CY25422	1.65	1.8	1.95	V
T _{AC}	Commercial ambient temperature	0	–	+70	°C
T _{AI}	Industrial ambient temperature	–40	--	+85	°C
C _{LOAD}	Maximum load capacitance	–	–	15	pF
t _{PU}	Power-up time for all V _{DD} to reach minimum specified voltage (power ramps must be monotonic)	0.05	–	500	ms

DC Electrical Specifications

Parameter	Description	Conditions	Min	Typ	Max	Unit
V _{OL}	Output low voltage	I _{OL} = 2 mA, drive strength = [00]	–	–	0.4	V
		I _{OL} = 3 mA, drive strength = [01]				
		I _{OL} = 7 mA, drive strength = [10]				
		I _{OL} = 12 mA, drive strength = [11]				
V _{OH}	Output high voltage	I _{OH} = –2 mA, drive strength = [00]	V _{DD} – 0.4	–	–	V
		I _{OH} = –3 mA, drive strength = [01]				
		I _{OH} = –7 mA, drive strength = [10]				
		I _{OH} = –12 mA, drive strength = [11]				
V _{IL1}	Input low voltage of PD#/OE, FS0, FS1 and SSON	–	–	–	0.2*V _{DD}	V
V _{IL2}	Input low voltage of EXCLKIN	–	–	–	0.18	V
V _{IH1}	Input High Voltage of PD#/OE, FS0, FS1 and SSON	–	0.8*V _{DD}	–	–	V
V _{IH2}	Input high voltage of EXCLKIN for CY25402/CY25422	–	1.62	–	2.2	V
V _{IH3}	Input high voltage of EXCLKIN for CY25482	–	0.8*V _{DD}	–	–	V
I _{IL}	Input low current, PD#/OE/FS1	V _{IN} = 0V	–	–	10	μA
I _{IH}	Input high current, PD#/OE/FS1	V _{IN} = V _{DD}	–	–	10	μA
I _{ILDN}	Input low current, SSON and FS0 pins	V _{IN} = 0V (Internal pull down resistor = 160k typ.)	–	–	10	μA
I _{IHDN}	Input high current, SSON and FS0 pins	V _{IN} = V _{DD} (Internal pull down resistor = 160k typ.)	14	–	36	μA
R _{DN}	Pull-down resistor of CLK1, REFOUT/FS0 and CLK2/SSON pins	Output clocks in off state by setting PD# = Low	100	160	250	kΩ
I _{DD} ^[1,2]	Supply current for CY25422	PD# = High, No load	–	12	–	mA
	Supply current for CY25402/CY25482	PD# = High, No load	–	14	–	mA
I _{DDS} ^[1]	Standby current	PD# = Low	–	3	–	μA
C _{IN} ^[2]	Input capacitance	SSON, PD#/OE/FS1 and FS0 pins	–	–	7	pF

Notes

1. Guaranteed by design but not 100% tested
2. Configuration dependent.

AC Electrical Specifications

Parameter	Description	Conditions	Min	Typ	Max	Unit
F _{IN} (crystal)	Crystal Frequency, XIN		8	–	48	MHz
F _{IN} (clock)	Input Clock Frequency (EXCLKIN)		8	–	166	MHz
F _{CLK}	Output Clock Frequency		3	–	166	MHz
DC	Output Duty Cycle, All Clocks except Ref Out	Duty Cycle is defined in Figure 5 on page 9 ; t ₁ /t ₂ , measured at 50% of V _{DD}	45	50	55	%
DC	Ref Out Duty Cycle	Ref In Min 45%, Max 55%	40	–	60	%
T _{RF1} ^[3]	Output Rise/Fall Time	Measured from 20% to 80% of V _{DD} , as shown in Figure 6 on page 9 , C _{LOAD} = 15 pF, drive strength [00]	–	6.8	–	ns
T _{RF2} ^[3]	Output Rise/Fall Time	Measured from 20% to 80% of V _{DD} , as shown in Figure 6 on page 9 , C _{LOAD} = 15 pF, drive strength [01]	–	3.4	–	ns
T _{RF3} ^[3]	Output Rise/Fall Time	Measured from 20% to 80% of V _{DD} , as shown in Figure 6 on page 9 , C _{LOAD} = 15 pF, drive strength [10]	–	2.0	–	ns
T _{RF4} ^[3]	Output Rise/Fall Time	Measured from 20% to 80% of V _{DD} , as shown in Figure 6 on page 9 , C _{LOAD} = 15 pF, drive strength [11]	–	1.0	–	ns
T _{CCJ} ^[3,4]	Cycle-to-cycle Jitter (peak)	Configuration dependent. See Table 5	–	100	–	ps
T _{LOCK} ^[4]	PLL Lock Time	Measured from 90% of the applied power supply level	–	1	3	ms

Table 6. Configuration Example for C-C Jitter

Ref. Frequency (MHz)	CLK1 Output		CLK2 Output	
	Freq. (MHz)	C-C Jitter Typ (ps)	Freq. (MHz)	C-C Jitter Typ (ps)
14.3181	8.0	134	48	92
19.2	74.25	99	8	91
27	48	67	166	103
48	48	93	166	137

Recommended Crystal Specification for SMD Package

Parameter	Description	Range 1	Range 2	Range 3	Unit
Fmin	Minimum frequency	8	14	28	MHz
Fmax	Maximum frequency	14	28	48	MHz
R1	Motional resistance (ESR)	135	50	30	Ω
C0	Shunt capacitance	4	4	2	pF
CL	Parallel load capacitance	18	14	12	pF
DL(max)	Maximum crystal drive level	300	300	300	μW

Notes

- 3. Guaranteed by design but not 100% tested
- 4. Configuration dependent.

Recommended Crystal Specification for Thru-Hole Package

Parameter	Description	Range 1	Range 2	Range 3	Unit
Fmin	Minimum frequency	8	14	24	MHz
Fmax	Maximum frequency	14	24	32	MHz
R1	Motional resistance (ESR)	90	50	30	Ω
C0	Shunt capacitance	7	7	7	pF
CL	Parallel load capacitance	18	12	12	pF
DL(max)	Maximum crystal drive level	1000	1000	1000	μ W

Test and Measurement Setup

Figure 4. Test and Measurement Setup

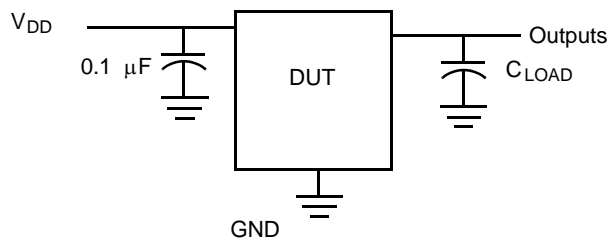

Voltage and Timing Definitions

Figure 5. Duty Cycle Definition

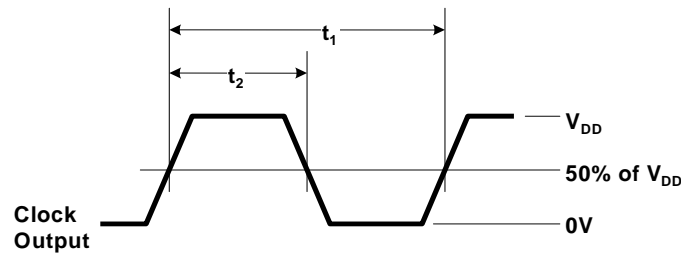
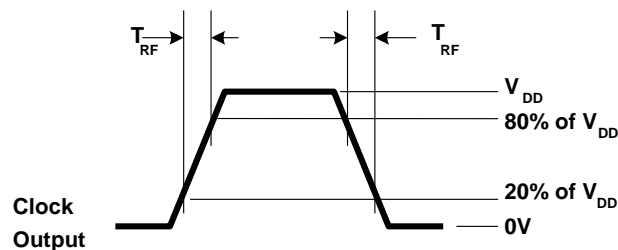

Figure 6. Rise Time = T_{RF} , Fall Time = T_{RF}



Ordering Information

Part Number	Type	Package	Supply Voltage	Production Flow
Pb-free				
CY25402SXC	Field Programmable	8-pin SOIC	2.5 V, 3.0 V, or 3.3 V	Commercial, 0 °C to 70 °C
CY25402SXCT	Field Programmable	8-pin SOIC -Tape and reel	2.5 V, 3.0 V, or 3.3 V	Commercial, 0 °C to 70 °C
CY25422FSXC	Field Programmable	8-pin SOIC	1.8 V	Commercial, 0 °C to 70 °C
CY25422FSXCT	Field Programmable	8-pin SOIC -Tape and reel	1.8 V	Commercial, 0 °C to 70 °C
CY25482SXC	Field Programmable	8-pin SOIC	2.5 V, 3.0 V, or 3.3 V	Commercial, 0 °C to 70 °C
CY25482SXCT	Field Programmable	8-pin SOIC -Tape and reel	2.5 V, 3.0 V, or 3.3 V	Commercial, 0 °C to 70 °C
CY25402SXI	Field Programmable	8-pin SOIC	2.5 V, 3.0 V, or 3.3 V	Industrial, -40 °C to +85 °C
CY25402SXIT	Field Programmable	8-pin SOIC -Tape and reel	2.5 V, 3.0 V, or 3.3 V	Industrial, -40 °C to +85 °C
CY25422FSXI	Field Programmable	8-pin SOIC	1.8 V	Industrial, -40 °C to +85 °C
CY25422FSXIT	Field Programmable	8-pin SOIC -Tape and reel	1.8 V	Industrial, -40 °C to +85 °C
CY25482SXI	Field Programmable	8-pin SOIC	2.5 V, 3.0 V, or 3.3 V	Industrial, -40 °C to +85 °C
CY25482SXIT	Field Programmable	8-pin SOIC -Tape and reel	2.5 V, 3.0 V, or 3.3 V	Industrial, -40 °C to +85 °C
Programmer				
CY3675-CLKMAKER1	Programming kit			
CY3675-SOIC8A	Socket Adapter Board, for programming CY25402, CY25403, CY25422, CY25423, CY25482 and CY25483			

Possible Configurations

Some product offerings are factory programmed customer specific devices with customized part numbers. The Possible Configurations table shows the available device types, but not complete part numbers. Contact your local Cypress FAE or Sales Representative for more information.

Part Number ^[5]	Type	Package	Supply Voltage	Production Flow
Pb-free				
CY25402SXC-xxx	Factory Programmed	8-pin SOIC	2.5 V, 3.0 V, or 3.3 V	Commercial, 0 °C to 70 °C
CY25402SXC-xxxT	Factory Programmed	8-pin SOIC -Tape and reel	2.5 V, 3.0 V, or 3.3 V	Commercial, 0 °C to 70 °C
CY25422SXC-xxx	Factory Programmed	8-pin SOIC	1.8 V	Commercial, 0 °C to 70 °C
CY25422SXC-xxxT	Factory Programmed	8-pin SOIC -Tape and reel	1.8 V	Commercial, 0 °C to 70 °C
CY25482SXC-xxx	Factory Programmed	8-pin SOIC	2.5 V, 3.0 V, or 3.3 V	Commercial, 0 °C to 70 °C
CY25482SXC-xxxT	Factory Programmed	8-pin SOIC -Tape and reel	2.5 V, 3.0 V, or 3.3 V	Commercial, 0 °C to 70 °C
CY25402SXI-xxx	Factory Programmed	8-pin SOIC	2.5 V, 3.0 V, or 3.3 V	Industrial, -40 °C to +85 °C
CY25402SXI-xxxT	Factory Programmed	8-pin SOIC -Tape and reel	2.5 V, 3.0 V, or 3.3 V	Industrial, -40 °C to +85 °C
CY25422SXI-xxx	Factory Programmed	8-pin SOIC	1.8 V	Industrial, -40 °C to +85 °C
CY25422SXI-xxxT	Factory Programmed	8-pin SOIC -Tape and reel	1.8 V	Industrial, -40 °C to +85 °C
CY25482SXI-xxx	Factory Programmed	8-pin SOIC	2.5 V, 3.0 V, or 3.3 V	Industrial, -40 °C to +85 °C
CY25482SXI-xxxT	Factory Programmed	8-pin SOIC -Tape and reel	2.5 V, 3.0 V, or 3.3 V	Industrial, -40 °C to +85 °C

Note

5. xxx indicates Factory Programmable and are factory programmed configurations. For more details, contact your local Cypress FAE or Cypress Sales Representative

Ordering Code Definitions

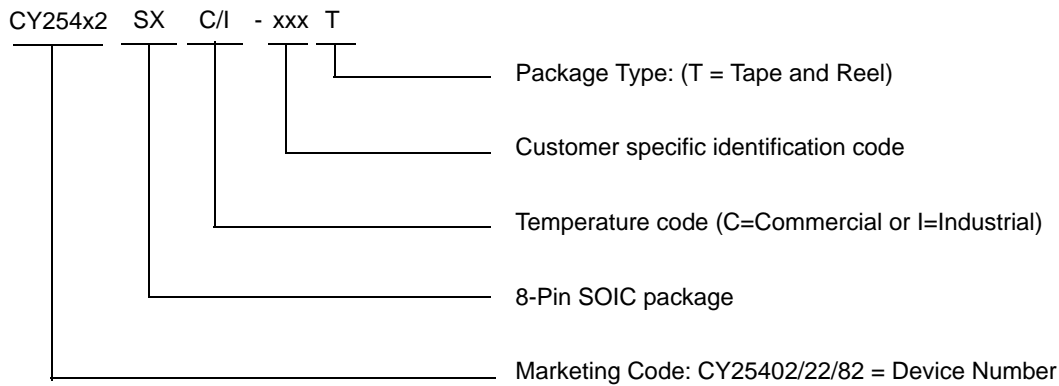

Package Drawing and Dimensions

Figure 7. 8-Pin (150-Mil) SOIC S8

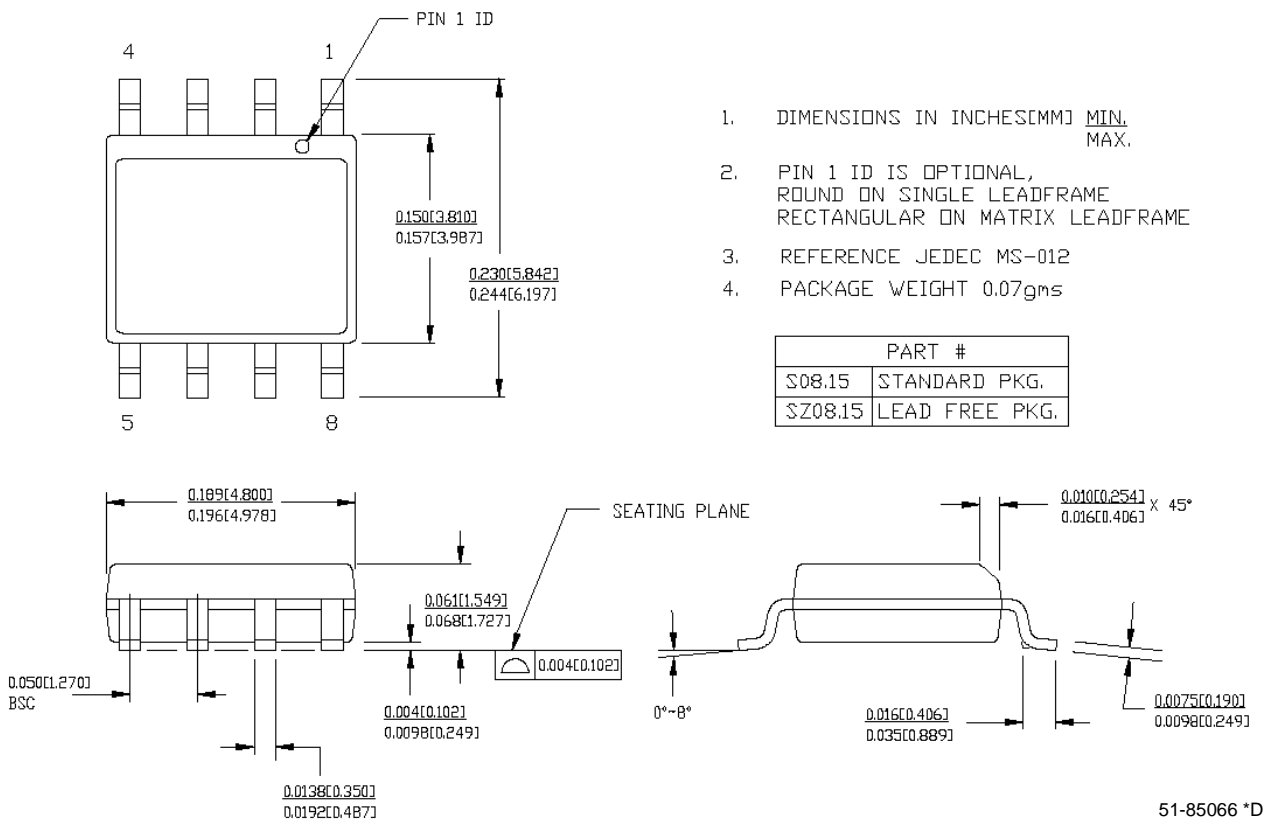

Acronyms

Acronym	Description
DL	drive level
DNU	do not use
DUT	device under test
EMI	electromagnetic interference
ESD	electrostatic discharge
FAE	field application engineer
FS	frequency select
JEDEC EIA	joint electron devices engineering council electronic industries alliance
LVC MOS	low voltage complementary metal oxide semiconductor
OE	output enable
OSC	oscillator
PD	power down
PLL	phase locked loop
PPM	parts per million
SS	spread spectrum
SSC	spread spectrum clock
SSON	spread spectrum on

Document Conventions

Units of Measure

Symbol	Unit of Measure
°C	degrees Celsius
fF	femtofarads
mA	milliampere
MHz	megahertz
μs	microseconds
ms	millisecond
μW	microwatts
ns	nanoseconds
pF	picofarads
ppm	parts per million
ps	picoseconds
V	volts
Ω	ohms
W	watts

Document History Page

Document Title: CY25402/CY25422/CY25482 Two PLL Programmable Clock Generator with Spread Spectrum				
Document Number: 001-12565				
REV.	ECN NO.	Issue Date	Orig. of Change	Description of Change
**	690296	See ECN	RGL	New Data Sheet
*A	815788	See ECN	RGL	Minor Change: To post on web
*B	1428744	See ECN	RGL/AESA	Changed data sheet format to match generic part, CY2544/46 Added new device and specification for high ref. input voltage part, CY25482 Removed Preliminary from Title page Replaced CLK2 with REFOUT
*C	2748211	08/10/09	TSAI	Posting to external web.
*D	2898568	06/02/10	KVM	Updated the Ordering Information table and package diagram. Moved 'xxx' parts to Possible Configurations table. Updated template.
*E	3110175	12/14/2010	BASH	Updated as per new template Added Units of Measure table
*F	3235621	04/20/2011	CXQ	Changed part number from CY25422SXC to CY25422FSXC, from CY25422SXCT to CY25422FSXCT, from CY25422SXI to CY25422FSXI, and from CY25422SXIT to CY25422FSXIT.

Sales, Solutions, and Legal Information

Worldwide Sales and Design Support

Cypress maintains a worldwide network of offices, solution centers, manufacturer's representatives, and distributors. To find the office closest to you, visit us at [Cypress Locations](#).

Products

Automotive	cypress.com/go/automotive
Clocks & Buffers	cypress.com/go/clocks
Interface	cypress.com/go/interface
Lighting & Power Control	cypress.com/go/powerpsoc cypress.com/go/plc
Memory	cypress.com/go/memory
Optical & Image Sensing	cypress.com/go/image
PSoC	cypress.com/go/psoc
Touch Sensing	cypress.com/go/touch
USB Controllers	cypress.com/go/USB
Wireless/RF	cypress.com/go/wireless

PSoC® Solutions

psoc.cypress.com/solutions

PSoC 1 | PSoC 3 | PSoC 5

© Cypress Semiconductor Corporation, 2009-2011. The information contained herein is subject to change without notice. Cypress Semiconductor Corporation assumes no responsibility for the use of any circuitry other than circuitry embodied in a Cypress product. Nor does it convey or imply any license under patent or other rights. Cypress products are not warranted nor intended to be used for medical, life support, life saving, critical control or safety applications, unless pursuant to an express written agreement with Cypress. Furthermore, Cypress does not authorize its products for use as critical components in life-support systems where a malfunction or failure may reasonably be expected to result in significant injury to the user. The inclusion of Cypress products in life-support systems application implies that the manufacturer assumes all risk of such use and in doing so indemnifies Cypress against all charges.

Any Source Code (software and/or firmware) is owned by Cypress Semiconductor Corporation (Cypress) and is protected by and subject to worldwide patent protection (United States and foreign), United States copyright laws and international treaty provisions. Cypress hereby grants to licensee a personal, non-exclusive, non-transferable license to copy, use, modify, create derivative works of, and compile the Cypress Source Code and derivative works for the sole purpose of creating custom software and or firmware in support of licensee product to be used only in conjunction with a Cypress integrated circuit as specified in the applicable agreement. Any reproduction, modification, translation, compilation, or representation of this Source Code except as specified above is prohibited without the express written permission of Cypress.

Disclaimer: CYPRESS MAKES NO WARRANTY OF ANY KIND, EXPRESS OR IMPLIED, WITH REGARD TO THIS MATERIAL, INCLUDING, BUT NOT LIMITED TO, THE IMPLIED WARRANTIES OF MERCHANTABILITY AND FITNESS FOR A PARTICULAR PURPOSE. Cypress reserves the right to make changes without further notice to the materials described herein. Cypress does not assume any liability arising out of the application or use of any product or circuit described herein. Cypress does not authorize its products for use as critical components in life-support systems where a malfunction or failure may reasonably be expected to result in significant injury to the user. The inclusion of Cypress' product in a life-support systems application implies that the manufacturer assumes all risk of such use and in doing so indemnifies Cypress against all charges.

Use may be limited by and subject to the applicable Cypress software license agreement.