





Features

- Compliant with AEC-Q200 Rev-C- Stress Test Qualification for Passive Components in Automotive Applications
- 100 % electrically compatible with all previous generations of 1812 SMT devices
- Compatible with Pb and Pb-free solder reflow profiles
- RoHS compliant* and halogen free**
- Surface mount packaging for automated assembly
- Agency recognition:   
- Standard 4532 mm (1812 mils) footprint
- Patents pending

MF-MSMF Series - PTC Resettable Fuses

Electrical Characteristics

| Model | V max. Volts | I max. Amps | I _{hold} | I _{trip} | Resistance | | Max. Time To Trip | | Tripped Power Dissipation |
|----------------|--------------|-------------|-------------------|-------------------|-------------------|--------------------|-------------------|------------------|---------------------------|
| | | | Amperes at 23 °C | | Ohms at 23 °C | | Amperes at 23 °C | Seconds at 23 °C | Watts at 23 °C |
| | | | Hold | Trip | R _{Min.} | R _{1Max.} | | | Typ. |
| MF-MSMF010 | 60.0 | 40 | 0.10 | 0.30 | 0.70 | 15.00 | 0.5 | 1.50 | 0.8 |
| MF-MSMF014 | 60.0 | 40 | 0.14 | 0.34 | 0.40 | 6.50 | 1.5 | 0.15 | 0.8 |
| MF-MSMF020 | 30.0 | 80 | 0.20 | 0.40 | 0.40 | 6.00 | 6.0 | 0.06 | 0.8 |
| MF-MSMF020/60 | 60.0 | 40 | 0.20 | 0.40 | 0.40 | 6.00 | 1.5 | 0.15 | 0.8 |
| MF-MSMF030 | 30.0 | 10 | 0.30 | 0.60 | 0.30 | 3.00 | 8.0 | 0.10 | 0.8 |
| MF-MSMF050 | 15.0 | 100 | 0.50 | 1.00 | 0.15 | 1.00 | 8.0 | 0.15 | 0.8 |
| MF-MSMF075 | 13.2 | 100 | 0.75 | 1.50 | 0.11 | 0.45 | 8.0 | 0.20 | 0.8 |
| MF-MSMF075/24 | 24.0 | 40 | 0.75 | 1.50 | 0.11 | 0.45 | 8.0 | 0.20 | 0.8 |
| MF-MSMF110 | 6.0 | 100 | 1.10 | 2.20 | 0.04 | 0.21 | 8.0 | 0.30 | 0.8 |
| MF-MSMF110/16 | 16.0 | 100 | 1.10 | 2.20 | 0.04 | 0.21 | 8.0 | 0.30 | 0.8 |
| MF-MSMF110/24X | 24.0 | 20 | 1.10 | 2.20 | 0.06 | 0.18 | 8.0 | 0.50 | 0.8 |
| MF-MSMF125 | 6.0 | 100 | 1.25 | 2.50 | 0.035 | 0.14 | 8.0 | 0.40 | 0.8 |
| MF-MSMF150 | 6.0 | 100 | 1.50 | 3.00 | 0.03 | 0.120 | 8.0 | 0.5 | 0.8 |
| MF-MSMF150/24X | 24.0 | 20 | 1.50 | 3.00 | 0.03 | 0.120 | 8.0 | 1.50 | 1.0 |
| MF-MSMF160 | 8.0 | 100 | 1.60 | 2.80 | 0.035 | 0.099 | 8.0 | 2.0 | 0.8 |
| MF-MSMF200 | 8.0 | 40 | 2.00 | 4.00 | 0.020 | 0.080 | 8.0 | 3.0 | 0.8 |
| MF-MSMF250/16X | 16.0 | 100 | 2.50 | 5.00 | 0.015 | 0.100 | 8.0 | 5.0 | 1.2 |
| MF-MSMF260 | 6.0 | 100 | 2.60 | 5.20 | 0.015 | 0.080 | 8.0 | 5.0 | 0.8 |

Environmental Characteristics

| | | |
|---|--|---------------------------------|
| Operating Temperature..... | -40 °C to +85 °C | |
| Maximum Device Surface Temperature in Tripped State | 125 °C | |
| Passive Aging | +85 °C, 1000 hours..... ±5 % typical resistance change | |
| Humidity Aging..... | +85 °C, 85 % R.H. 1000 hours | ±5 % typical resistance change |
| Thermal Shock | +85 °C to -40 °C, 20 times..... | ±10 % typical resistance change |
| Solvent Resistance..... | MIL-STD-202, Method 215 | No change |
| Vibration | MIL-STD-883C, Method 2007.1,..... | No change |
| | Condition A | |

Test Procedures And Requirements For Model MF-MSMF Series

| Test | Test Conditions | Accept/Reject Criteria |
|------------------------------|---|--|
| Visual/Mech..... | Verify dimensions and materials..... | Per MF physical description |
| Resistance..... | In still air @ 23 °C | R _{min} ≤ R ≤ R _{1max} |
| Time to Trip..... | At specified current, V _{max} , 23 °C..... | T ≤ max. time to trip (seconds) |
| Hold Current | 30 min. at I _{hold} | No trip |
| Trip Cycle Life..... | V _{max} , I _{max} , 100 cycles..... | No arcing or burning |
| Trip Endurance | V _{max} , 48 hours..... | No arcing or burning |
| Solderability | ANSI/J-STD-002 | 95 % min. coverage |
| | | |
| UL File Number | E174545 http://www.ul.com/ Follow link to Certifications, then UL File No., enter E174545 | |
| CSA File Number..... | CA110338 http://directories.csa-international.org/ Under "Certification Record" and "File Number" enter 110338-0-000 | |
| TÜV Certificate Number | R 02057213 http://www.tuvdotcom.com/ Follow link to "other certificates", enter File No. 2057213 | |

*RoHS Directive 2002/95/EC Jan 27, 2003 including Annex.
 **Bourns is using the definition that appears to be the prevalent definition used as the industry standard at this time. The Bourns definition of "halogen-free" is:
 Bromine (Br) content: ≤ 900 ppm; Chlorine (Cl) content: ≤ 900 ppm; Total Br + Cl content: ≤ 1500 ppm.

Specifications are subject to change without notice.
 Users should verify actual device performance in their specific applications.
 The device characteristics and parameters in this data sheet can and do vary in different applications and actual device performance may vary over time.

Applications

- Overcurrent and overtemperature protection of automotive electronics
- Hard disk drives
- PC motherboards
- PC peripherals
- Point-of-sale (POS) equipment
- PCMCIA cards
- USB port protection - USB 2.0, 3.0 & OTG
- HDMI 1.4 Source protection

MF-MSMF Series - PTC Resettable Fuses

BOURNS®

Product Dimensions (see next page for outline drawings)

| Model | A | | B | | C | | D | Style |
|----------------|------------------------|------------------------|------------------------|------------------------|------------------------|------------------------|------------------------|-------|
| | Min. | Max. | Min. | Max. | Min. | Max. | Min. | |
| MF-MSMF010 | $\frac{4.37}{(0.172)}$ | $\frac{4.73}{(0.186)}$ | $\frac{3.07}{(0.121)}$ | $\frac{3.41}{(0.134)}$ | $\frac{0.70}{(0.028)}$ | $\frac{1.10}{(0.043)}$ | $\frac{0.30}{(0.012)}$ | 1 |
| MF-MSMF014 | $\frac{4.37}{(0.172)}$ | $\frac{4.73}{(0.186)}$ | $\frac{3.07}{(0.121)}$ | $\frac{3.41}{(0.134)}$ | $\frac{0.70}{(0.028)}$ | $\frac{1.10}{(0.043)}$ | $\frac{0.30}{(0.012)}$ | 1 |
| MF-MSMF020 | $\frac{4.37}{(0.172)}$ | $\frac{4.73}{(0.186)}$ | $\frac{3.07}{(0.121)}$ | $\frac{3.41}{(0.134)}$ | $\frac{0.70}{(0.028)}$ | $\frac{1.10}{(0.043)}$ | $\frac{0.30}{(0.012)}$ | 1 |
| MF-MSMF020/60 | $\frac{4.37}{(0.172)}$ | $\frac{4.73}{(0.186)}$ | $\frac{3.07}{(0.121)}$ | $\frac{3.41}{(0.134)}$ | $\frac{0.70}{(0.028)}$ | $\frac{1.10}{(0.043)}$ | $\frac{0.30}{(0.012)}$ | 1 |
| MF-MSMF030 | $\frac{4.37}{(0.172)}$ | $\frac{4.73}{(0.186)}$ | $\frac{3.07}{(0.121)}$ | $\frac{3.41}{(0.134)}$ | $\frac{0.70}{(0.028)}$ | $\frac{1.10}{(0.043)}$ | $\frac{0.30}{(0.012)}$ | 1 |
| MF-MSMF050 | $\frac{4.37}{(0.172)}$ | $\frac{4.73}{(0.186)}$ | $\frac{3.07}{(0.121)}$ | $\frac{3.41}{(0.134)}$ | $\frac{0.55}{(0.015)}$ | $\frac{0.85}{(0.033)}$ | $\frac{0.30}{(0.012)}$ | 1 |
| MF-MSMF075 | $\frac{4.37}{(0.172)}$ | $\frac{4.73}{(0.186)}$ | $\frac{3.07}{(0.121)}$ | $\frac{3.41}{(0.134)}$ | $\frac{0.55}{(0.015)}$ | $\frac{0.85}{(0.033)}$ | $\frac{0.30}{(0.012)}$ | 1 |
| MF-MSMF075/24 | $\frac{4.37}{(0.172)}$ | $\frac{4.73}{(0.186)}$ | $\frac{3.07}{(0.121)}$ | $\frac{3.41}{(0.134)}$ | $\frac{0.55}{(0.015)}$ | $\frac{0.85}{(0.033)}$ | $\frac{0.30}{(0.012)}$ | 1 |
| MF-MSMF110 | $\frac{4.37}{(0.172)}$ | $\frac{4.73}{(0.186)}$ | $\frac{3.07}{(0.121)}$ | $\frac{3.41}{(0.134)}$ | $\frac{0.45}{(0.018)}$ | $\frac{0.85}{(0.033)}$ | $\frac{0.30}{(0.012)}$ | 1 |
| MF-MSMF110/16 | $\frac{4.37}{(0.172)}$ | $\frac{4.73}{(0.186)}$ | $\frac{3.07}{(0.121)}$ | $\frac{3.41}{(0.134)}$ | $\frac{0.45}{(0.018)}$ | $\frac{0.85}{(0.033)}$ | $\frac{0.30}{(0.012)}$ | 1 |
| MF-MSMF110/24X | $\frac{4.37}{(0.172)}$ | $\frac{4.83}{(0.190)}$ | $\frac{3.07}{(0.121)}$ | $\frac{3.41}{(0.134)}$ | $\frac{0.70}{(0.028)}$ | $\frac{1.60}{(0.063)}$ | $\frac{0.30}{(0.012)}$ | 2 |
| MF-MSMF125 | $\frac{4.37}{(0.172)}$ | $\frac{4.73}{(0.186)}$ | $\frac{3.07}{(0.121)}$ | $\frac{3.41}{(0.134)}$ | $\frac{0.55}{(0.015)}$ | $\frac{0.85}{(0.033)}$ | $\frac{0.30}{(0.012)}$ | 1 |
| MF-MSMF150 | $\frac{4.37}{(0.172)}$ | $\frac{4.73}{(0.186)}$ | $\frac{3.07}{(0.121)}$ | $\frac{3.41}{(0.134)}$ | $\frac{0.55}{(0.015)}$ | $\frac{0.85}{(0.033)}$ | $\frac{0.30}{(0.012)}$ | 1 |
| MF-MSMF150/24X | $\frac{4.37}{(0.172)}$ | $\frac{4.83}{(0.190)}$ | $\frac{3.07}{(0.121)}$ | $\frac{3.41}{(0.134)}$ | $\frac{0.70}{(0.028)}$ | $\frac{1.60}{(0.063)}$ | $\frac{0.30}{(0.012)}$ | 2 |
| MF-MSMF160 | $\frac{4.37}{(0.172)}$ | $\frac{4.73}{(0.186)}$ | $\frac{3.07}{(0.121)}$ | $\frac{3.41}{(0.134)}$ | $\frac{0.55}{(0.015)}$ | $\frac{0.85}{(0.033)}$ | $\frac{0.30}{(0.012)}$ | 1 |
| MF-MSMF200 | $\frac{4.37}{(0.172)}$ | $\frac{4.73}{(0.186)}$ | $\frac{3.07}{(0.121)}$ | $\frac{3.41}{(0.134)}$ | $\frac{0.55}{(0.015)}$ | $\frac{0.85}{(0.033)}$ | $\frac{0.30}{(0.012)}$ | 1 |
| MF-MSMF250/16X | $\frac{4.37}{(0.172)}$ | $\frac{4.83}{(0.190)}$ | $\frac{3.07}{(0.121)}$ | $\frac{3.41}{(0.134)}$ | $\frac{0.70}{(0.028)}$ | $\frac{1.60}{(0.063)}$ | $\frac{0.30}{(0.012)}$ | 2 |
| MF-MSMF260 | $\frac{4.37}{(0.172)}$ | $\frac{4.73}{(0.186)}$ | $\frac{3.07}{(0.121)}$ | $\frac{3.41}{(0.134)}$ | $\frac{0.48}{(0.019)}$ | $\frac{0.85}{(0.033)}$ | $\frac{0.30}{(0.012)}$ | 1 |

Packaging:

MF-MSMF010 through MF-MSMF030 = 1500 pcs. per reel.
 MF-MSMF050 through MF-MSMF200 & MF-MSMF260 = 2000 pcs. per reel.
 MF-MSMF110/24X , MF-MSMF150/24X & MF-MSMF250/16X = 1500 pcs. per reel.

DIMENSIONS: $\frac{\text{MM}}{\text{(INCHES)}}$

MF-MSMF Series - PTC Resettable Fuses

BOURNS®

Product Dimensions (see previous page for dimensions)

Style 1

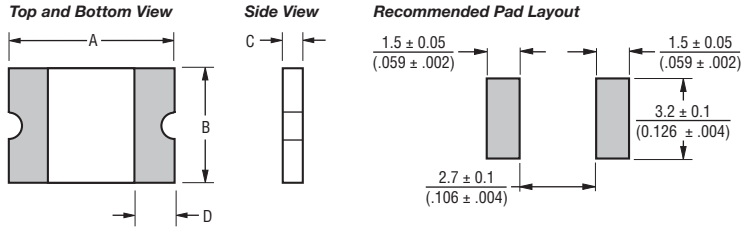

Terminal material:

Electroless Ni under immersion Au

Termination pad solderability:

Standard Au finish:

Meets ANSI/J-STD-002 Category 2.

Recommended Storage:

40 °C max./70 % RH max.

Style 2

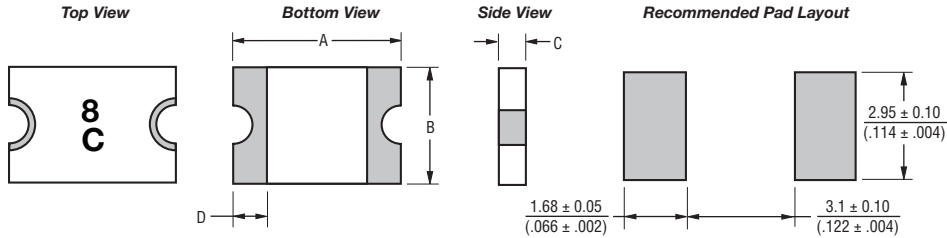

Typical Time to Trip at 23 °C

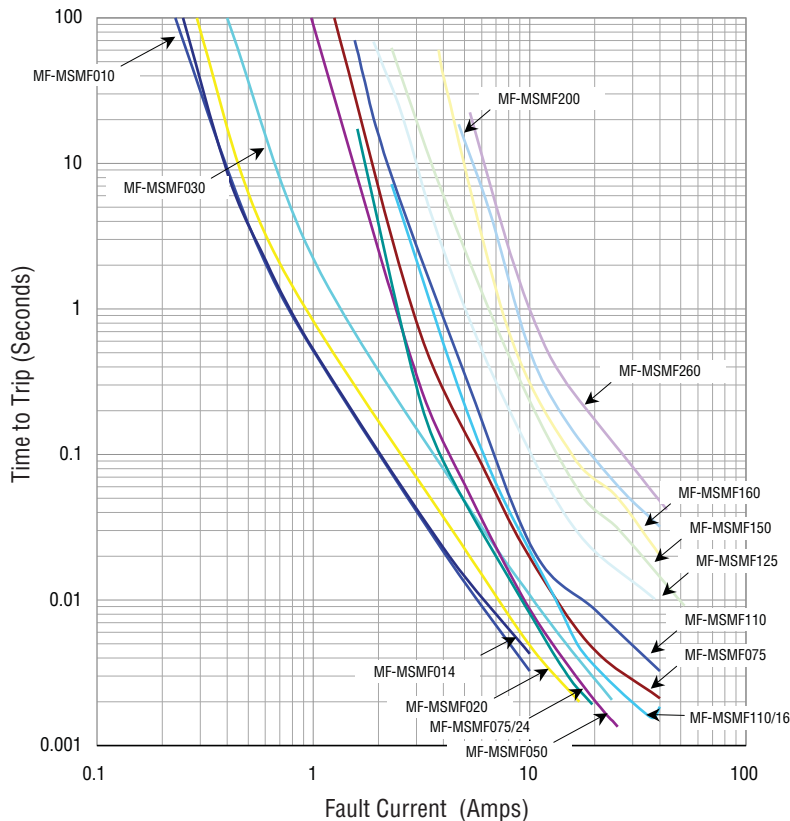

The Time to Trip curves represent typical performance of a device in a simulated application environment. Actual performance in specific customer applications may differ from these values due to the influence of other variables.

Specifications are subject to change without notice.

Users should verify actual device performance in their specific applications.

The device characteristics and parameters in this data sheet can and do vary in different applications and actual device performance may vary over time.

MF-MSMF Series - PTC Resettable Fuses

BOURNS®

Thermal Derating Chart - I_{hold} (Amps)

| Model | Ambient Operating Temperature | | | | | | | | |
|----------------|-------------------------------|--------|------|-------|-------|-------|-------|-------|-------|
| | -40 °C | -20 °C | 0 °C | 23 °C | 40 °C | 50 °C | 60 °C | 70 °C | 85 °C |
| MF-MSMF010 | 0.16 | 0.14 | 0.12 | 0.10 | 0.08 | 0.07 | 0.06 | 0.05 | 0.03 |
| MF-MSMF014 | 0.23 | 0.19 | 0.17 | 0.14 | 0.12 | 0.10 | 0.09 | 0.08 | 0.06 |
| MF-MSMF020 | 0.29 | 0.26 | 0.23 | 0.20 | 0.17 | 0.15 | 0.14 | 0.12 | 0.10 |
| MF-MSMF020/60 | 0.29 | 0.26 | 0.23 | 0.20 | 0.17 | 0.15 | 0.14 | 0.12 | 0.10 |
| MF-MSMF030 | 0.44 | 0.39 | 0.35 | 0.30 | 0.26 | 0.23 | 0.21 | 0.18 | 0.15 |
| MF-MSMF050 | 0.77 | 0.68 | 0.59 | 0.50 | 0.44 | 0.40 | 0.37 | 0.33 | 0.29 |
| MF-MSMF075 | 1.15 | 1.01 | 0.88 | 0.75 | 0.65 | 0.60 | 0.55 | 0.49 | 0.43 |
| MF-MSMF075/24 | 1.15 | 1.01 | 0.88 | 0.75 | 0.65 | 0.60 | 0.55 | 0.49 | 0.43 |
| MF-MSMF110 | 1.59 | 1.43 | 1.26 | 1.10 | 0.95 | 0.87 | 0.80 | 0.71 | 0.60 |
| MF-MSMF110/16 | 1.59 | 1.43 | 1.26 | 1.10 | 0.95 | 0.87 | 0.80 | 0.71 | 0.60 |
| MF-MSMF110/24X | 2.00 | 1.70 | 1.40 | 1.10 | 0.95 | 0.88 | 0.80 | 0.73 | 0.61 |
| MF-MSMF125 | 1.80 | 1.63 | 1.43 | 1.25 | 1.08 | 0.99 | 0.91 | 0.81 | 0.68 |
| MF-MSMF150 | 2.17 | 1.95 | 1.72 | 1.50 | 1.30 | 1.18 | 1.09 | 0.97 | 0.82 |
| MF-MSMF150/24X | 2.10 | 1.90 | 1.70 | 1.50 | 1.25 | 1.13 | 1.00 | 0.88 | 0.69 |
| MF-MSMF160 | 2.30 | 2.20 | 1.90 | 1.60 | 1.45 | 1.30 | 1.15 | 1.03 | 0.91 |
| MF-MSMF200 | 3.08 | 2.71 | 2.35 | 2.00 | 1.80 | 1.60 | 1.50 | 1.40 | 1.25 |
| MF-MSMF250/16X | 3.90 | 3.42 | 2.96 | 2.50 | 2.24 | 1.98 | 1.85 | 1.29 | 0.94 |
| MF-MSMF260 | 4.00 | 3.52 | 3.06 | 2.60 | 2.34 | 2.08 | 1.95 | 1.39 | 1.04 |

Solder Reflow Recommendations

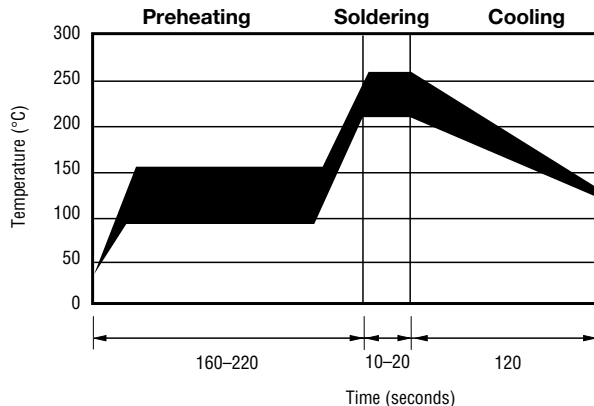

Notes:

- MF-MSMF models cannot be wave soldered. Please contact Bourns for hand soldering recommendations.
- If reflow temperatures exceed the recommended profile, devices may not meet the performance requirements.
- Compatible with Pb and Pb-free solder reflow profiles.
- Excess solder may cause a short circuit, especially during hand soldering. Please refer to the Multifuse® Polymer PTC product soldering recommendation guidelines.

How to Order

MF - MSMF 075/24 - 2

Multifuse® Product Designator
 Series
 MSMF = 4532 mm (1812 mils)
 Surface Mount Component
 Hold Current, I_{hold}
 010-260 (0.10 Amps - 2.60 Amps)
 Higher Voltage Option
 = Standard Voltage
 /16 = 16 Volt Rated
 /24 = 24 Volt Rated
 /60 = 60 Volt Rated
 X = Multifuse® freeXpansion Design™
 MF-MSMF Series
 Packaging
 Packaged per EIA 481-1
 -2 = Tape and Reel

Typical Part Marking

Represents total content. Layout may vary.

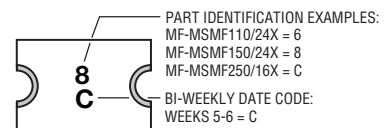
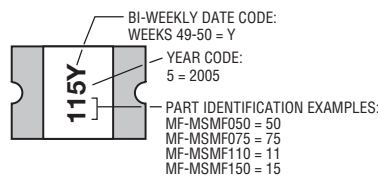

MF-MSMF SERIES, REV. AD, 02/13

"freeXpansion Design" is a trademark of Bourns, Inc.

Specifications are subject to change without notice.

Users should verify actual device performance in their specific applications.

The device characteristics and parameters in this data sheet can and do vary in different applications and actual device performance may vary over time.

MF-MSMF Series Tape and Reel Specifications

BOURNS®

| Tape Dimensions | MF-MSMF010 - MF-MSMF030 per EIA-481-1 | MF-MSMF050 - MF-MSMF260 per EIA 481-1 | MF-MSMF-110/24X MF-MSMF150/24X MF-MSMF250/16X per EIA 481-1 |
|------------------------|---|---|--|
| W | 12.0 ± 0.30 (0.472 ± 0.012) | 12.0 ± 0.30 (0.472 ± 0.012) | 12.0 ± 0.30 (0.472 ± 0.012) |
| P ₀ | 4.0 ± 0.10 (0.157 ± 0.004) | 4.0 ± 0.10 (0.157 ± 0.004) | 4.0 ± 0.10 (0.157 ± 0.004) |
| P ₁ | 8.0 ± 0.10 (0.315 ± 0.004) | 8.0 ± 0.10 (0.315 ± 0.004) | 8.0 ± 0.10 (0.315 ± 0.004) |
| P ₂ | 2.0 ± 0.05 (0.079 ± 0.002) | 2.0 ± 0.05 (0.079 ± 0.002) | 2.0 ± 0.05 (0.079 ± 0.002) |
| A ₀ | 3.58 ± 0.10 (0.141 ± 0.004) | 3.66 ± 0.15 (0.144 ± 0.006) | 3.70 ± 0.10 (0.146 ± 0.004) |
| B ₀ | 4.93 ± 0.10 (0.194 ± 0.004) | 4.98 ± 0.10 (0.196 ± 0.004) | 5.10 ± 0.10 (0.200 ± 0.004) |
| B ₁ max. | 5.9 (0.232) | 5.9 (0.232) | 5.9 (0.232) |
| D ₀ | $1.5 + 0.10/-0.0$ (0.059 + 0.004/-0) | $1.5 + 0.10/-0.0$ (0.059 + 0.004/-0) | $1.5 + 0.10/-0.0$ (0.059 + 0.004/-0) |
| F | 5.5 ± 0.05 (0.217 ± 0.002) | 5.5 ± 0.05 (0.217 ± 0.002) | 5.5 ± 0.05 (0.217 ± 0.002) |
| E ₁ | 1.75 ± 0.10 (0.069 ± 0.004) | 1.75 ± 0.10 (0.069 ± 0.004) | 1.75 ± 0.10 (0.069 ± 0.004) |
| E ₂ min. | 10.25 (0.404) | 10.25 (0.404) | 10.25 (0.404) |
| T max. | 0.6 (0.024) | 0.6 (0.024) | 0.6 (0.024) |
| T ₁ max. | 0.1 (0.004) | 0.1 (0.004) | 0.1 (0.004) |
| K ₀ | 1.30 ± 0.10 (0.051 ± 0.004) | 0.95 ± 0.10 (0.037 ± 0.004) | 1.50 ± 0.10 (0.059 ± 0.004) |
| Leader min. | 390 (15.35) | 390 (15.35) | 390 (15.35) |
| Trailer min. | 160 (6.30) | 160 (6.30) | 160 (6.30) |
| Reel Dimensions | | | |
| A max. | 185 (7.28) | 185 (7.28) | 185 (7.28) |
| N min. | 50 (1.97) | 50 (1.97) | 50 (1.97) |
| W ₁ | $12.4 + 2.0/-0.0$ (0.488 + 0.079/-0.0) | $12.4 + 2.0/-0.0$ (0.488 + 0.079/-0.0) | $12.4 + 2.0/-0.0$ (0.488 + 0.079/-0.0) |
| W ₂ max. | 18.4 (0.724) | 18.4 (0.724) | 18.4 (0.724) |

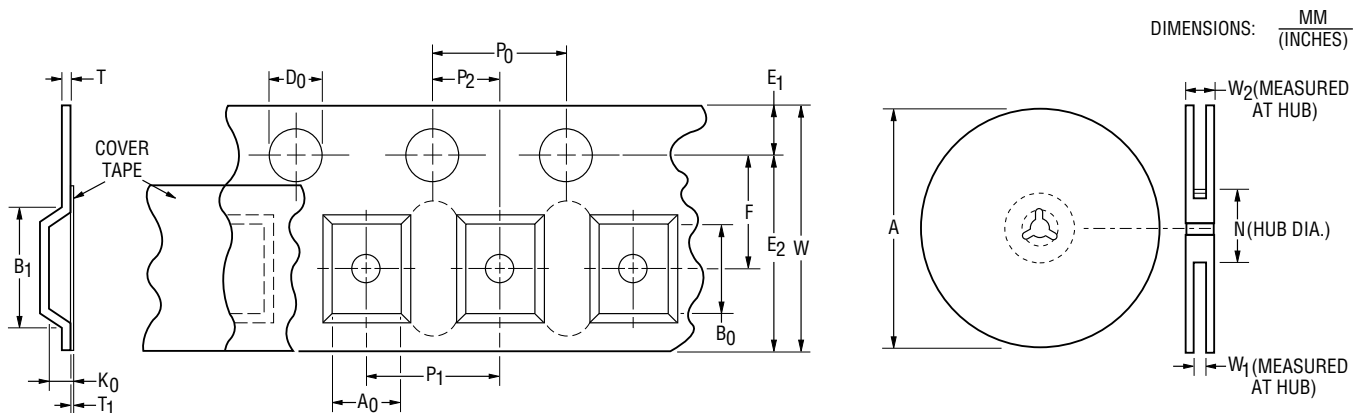

Specifications are subject to change without notice.
 Users should verify actual device performance in their specific applications.
 The device characteristics and parameters in this data sheet can and do vary in different applications and actual device performance may vary over time.