

Standard Recovery Diodes (Stud Version), 25 A



DO-203AA (DO-4)

FEATURES

- High surge current capability
- Stud cathode and stud anode version
- Wide current range
- Types up to 1200 V V_{RRM}
- Material categorization: for definitions of compliance please see www.vishay.com/doc?99912



RoHS
COMPLIANT

TYPICAL APPLICATIONS

- Battery charges
- Converters
- Power supplies
- Machine tool controls

PRODUCT SUMMARY

$I_{F(AV)}$	25 A
Package	DO-203AA (DO-4)
Circuit configuration	Single diode

MAJOR RATINGS AND CHARACTERISTICS

PARAMETER	TEST CONDITIONS	VALUES	UNITS
$I_{F(AV)}$		25	A
	T_C	120	°C
$I_{F(RMS)}$		40	A
I_{FSM}	50 Hz	356	A
	60 Hz	373	
I^2t	50 Hz	636	A ² s
	60 Hz	580	
V_{RRM}	Range	100 to 1200	V
T_J		-65 to +175	°C

ELECTRICAL SPECIFICATIONS

VOLTAGE RATINGS

TYPE NUMBER	VOLTAGE CODE	V_{RRM} , MAXIMUM REPETITIVE PEAK REVERSE VOLTAGE V	V_{RSM} , MAXIMUM NON-REPETITIVE PEAK VOLTAGE V	I_{RRM} MAXIMUM AT $T_J = 175$ °C mA
VS-25F(R)	10	100	150	12
	20	200	275	
	40	400	500	
	60	600	725	
	80	800	950	
	100	1000	1200	
	120	1200	1400	



FORWARD CONDUCTION					
PARAMETER	SYMBOL	TEST CONDITIONS		VALUES	UNITS
Maximum average forward current at case temperature	$I_{F(AV)}$	180° conduction, half sine wave		25	A
				120	°C
Maximum RMS forward current	$I_{F(RMS)}$			40	A
Maximum peak, one-cycle forward, non-repetitive surge current	I_{FSM}	t = 10 ms	No voltage reappplied	356	A
		t = 8.3 ms		373	
		t = 10 ms	100 % V_{RRM} reappplied	300	
		t = 8.3 ms		314	
Maximum I^2t for fusing	I^2t	t = 10 ms	No voltage reappplied	636	A ² s
		t = 8.3 ms		580	
		t = 10 ms	100 % V_{RRM} reappplied	450	
		t = 8.3 ms		410	
Maximum $I^2\sqrt{t}$ for fusing	$I^2\sqrt{t}$	t = 0.1 to 10 ms, no voltage reappplied		6360	A ² √s
Low level value of threshold voltage	$V_{F(TO)1}$	(16.7 % $\times \pi \times I_{F(AV)} < I < \pi \times I_{F(AV)}$), $T_J = T_J$ maximum		0.80	V
High level value of threshold voltage	$V_{F(TO)2}$	(I > $\pi \times I_{F(AV)}$), $T_J = T_J$ maximum		0.90	
Low level value of forward slope resistance	r_{f1}	(16.7 % $\times \pi \times I_{F(AV)} < I < \pi \times I_{F(AV)}$), $T_J = T_J$ maximum		6.80	mΩ
High level value of forward slope resistance	r_{f2}	(I > $\pi \times I_{F(AV)}$), $T_J = T_J$ maximum		5.70	
Maximum forward voltage drop	V_{FM}	$I_{pk} = 78$ A, $T_J = 25$ °C, $t_p = 400$ μs rectangular wave		1.30	V

THERMAL AND MECHANICAL SPECIFICATIONS					
PARAMETER	SYMBOL	TEST CONDITIONS		VALUES	UNITS
Maximum junction operating temperature range	T_J			-65 to +175	°C
Maximum storage temperature range	T_{Stg}			-65 to +200	
Maximum thermal resistance, junction to case	R_{thJC}	DC operation		1.5	K/W
Maximum thermal resistance, case to heat sink	R_{thCS}	Mounting surface, smooth, flat and greased		0.5	
Allowable mounting torque		Not lubricated threads		1.5 + 0 - 10 % (13)	N · m (lbf · in)
		Lubricated threads		1.2 + 0 - 10 % (10)	N · m (lbf · in)
Approximate weight				7	g
				0.25	oz.
Case style		See dimensions - link at the end of datasheet		DO-203AA (DO-4)	

ΔR_{thJC} CONDUCTION				
CONDUCTION ANGLE	SINUSOIDAL CONDUCTION	RECTANGULAR CONDUCTION	TEST CONDITIONS	UNITS
180°	0.28	0.24	$T_J = T_J$ maximum	K/W
120°	0.39	0.41		
90°	0.50	0.54		
60°	0.73	0.75		
30°	1.20	1.21		

Note

- The table above shows the increment of thermal resistance R_{thJC} when devices operate at different conduction angles than DC

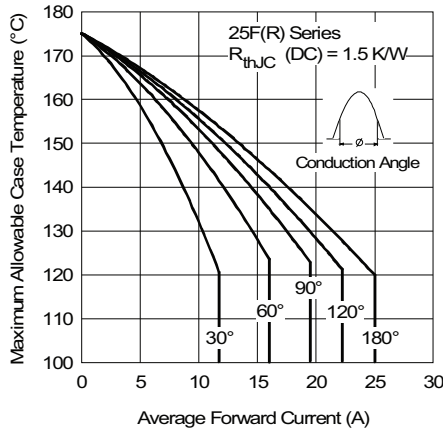

Fig. 1 - Current Ratings Characteristics

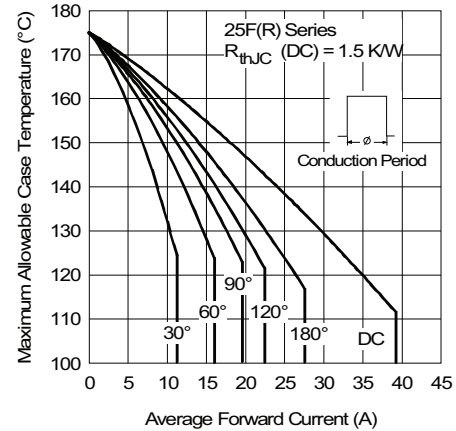

Fig. 2 - Current Ratings Characteristics

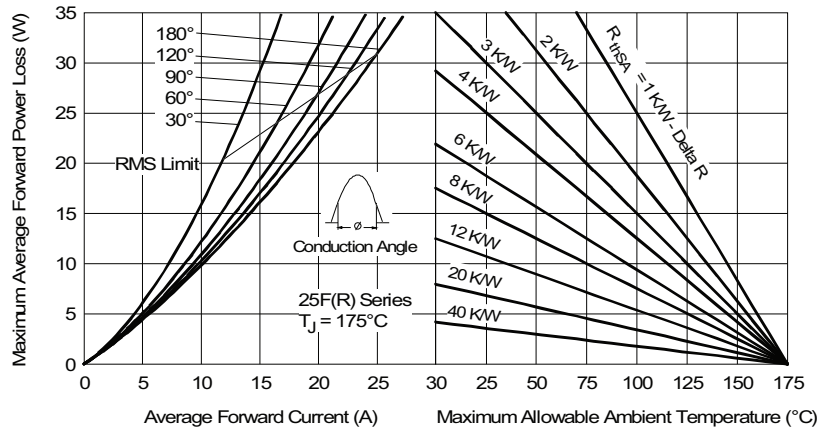

Fig. 3 - Forward Power Loss Characteristics

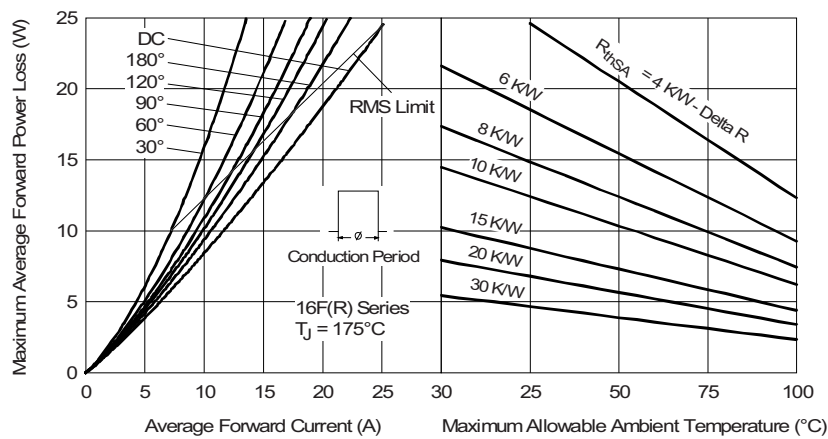

Fig. 4 - Forward Power Loss Characteristics

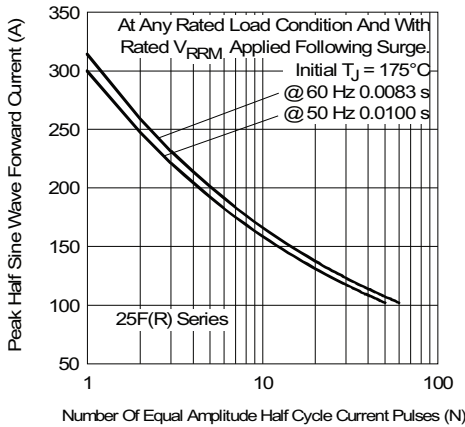

Fig. 5 - Maximum Non-Repetitive Surge Current

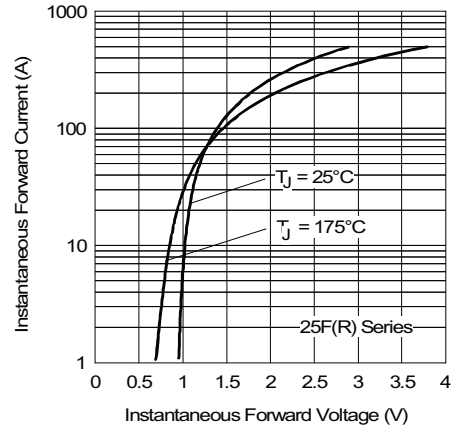

Fig. 7 - Forward Voltage Drop Characteristics

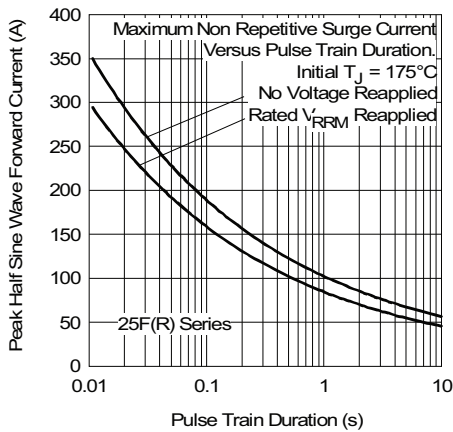

Fig. 6 - Maximum Non-Repetitive Surge Current

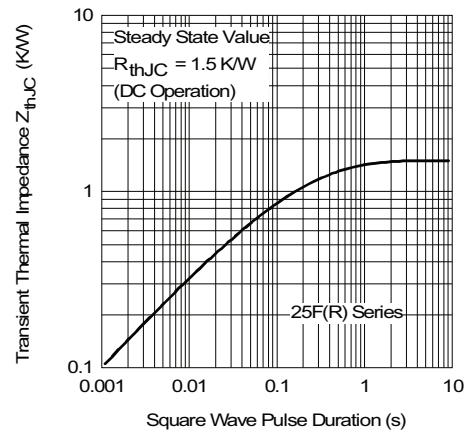

Fig. 8 - Thermal Impedance Z_{thJC} Characteristics

ORDERING INFORMATION TABLE

Device code	VS-	25	F	R	120	M
	①	②	③	④	⑤	⑥

- 1** - Vishay Semiconductors product
- 2** - Current rating: code = $I_{F(AV)}$
- 3** - F = standard device
- 4** - None = stud normal polarity (cathode to stud)
R = stud reverse polarity (anode to stud)
- 5** - Voltage code x 10 = V_{RRM} (see Voltage Ratings table)
- 6** - None = stud base DO-203AA (DO-4) 10-32UNF-2A
M = stud base DO-203AA (DO-4) M5 X 0.8

LINKS TO RELATED DOCUMENTS	
Dimensions	www.vishay.com/doc?95311

DO-203AA (DO-4)

DIMENSIONS in millimeters (inches)

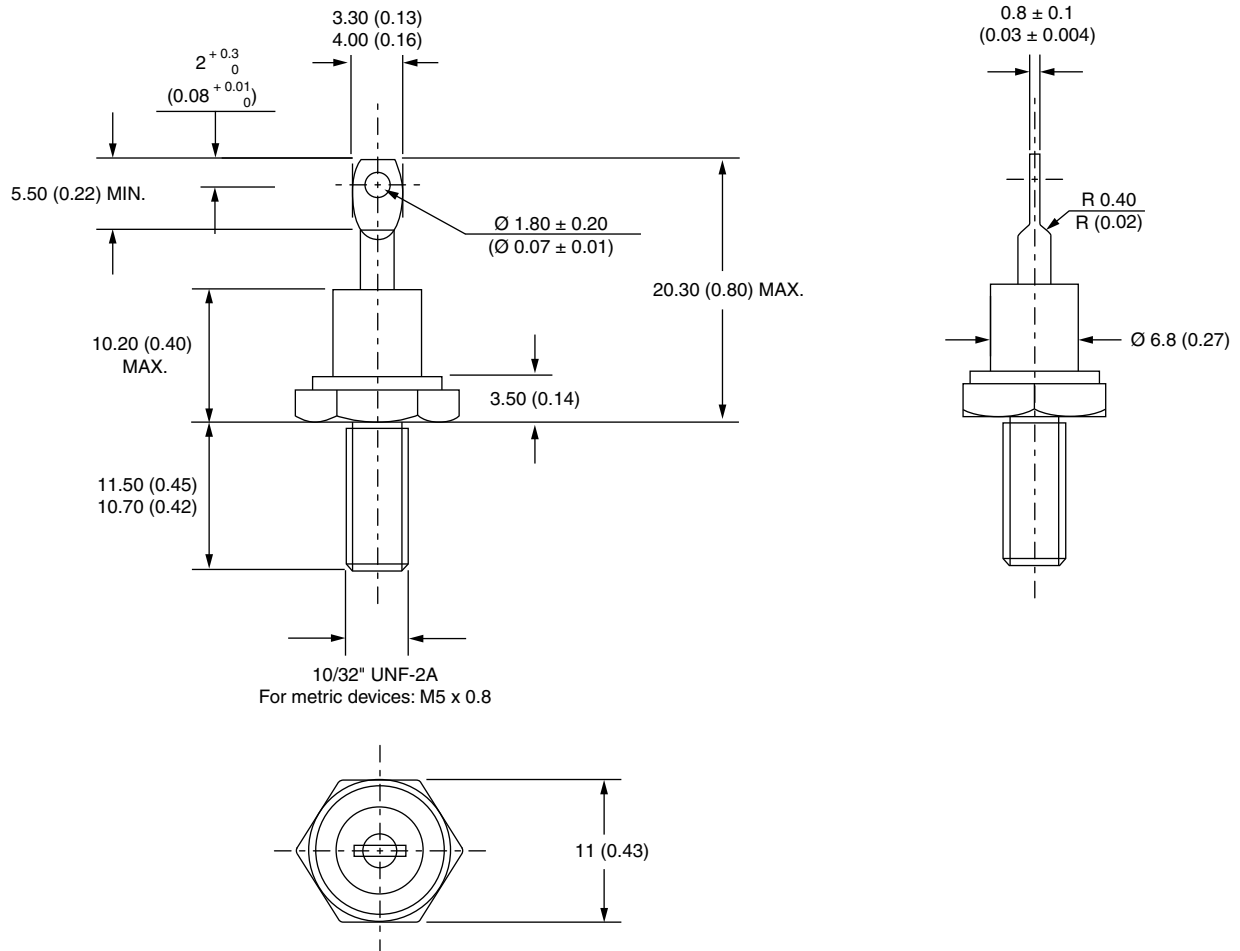



Disclaimer

ALL PRODUCT, PRODUCT SPECIFICATIONS AND DATA ARE SUBJECT TO CHANGE WITHOUT NOTICE TO IMPROVE RELIABILITY, FUNCTION OR DESIGN OR OTHERWISE.

Vishay Intertechnology, Inc., its affiliates, agents, and employees, and all persons acting on its or their behalf (collectively, "Vishay"), disclaim any and all liability for any errors, inaccuracies or incompleteness contained in any datasheet or in any other disclosure relating to any product.

Vishay makes no warranty, representation or guarantee regarding the suitability of the products for any particular purpose or the continuing production of any product. To the maximum extent permitted by applicable law, Vishay disclaims (i) any and all liability arising out of the application or use of any product, (ii) any and all liability, including without limitation special, consequential or incidental damages, and (iii) any and all implied warranties, including warranties of fitness for particular purpose, non-infringement and merchantability.

Statements regarding the suitability of products for certain types of applications are based on Vishay's knowledge of typical requirements that are often placed on Vishay products in generic applications. Such statements are not binding statements about the suitability of products for a particular application. It is the customer's responsibility to validate that a particular product with the properties described in the product specification is suitable for use in a particular application. Parameters provided in datasheets and / or specifications may vary in different applications and performance may vary over time. All operating parameters, including typical parameters, must be validated for each customer application by the customer's technical experts. Product specifications do not expand or otherwise modify Vishay's terms and conditions of purchase, including but not limited to the warranty expressed therein.

Except as expressly indicated in writing, Vishay products are not designed for use in medical, life-saving, or life-sustaining applications or for any other application in which the failure of the Vishay product could result in personal injury or death. Customers using or selling Vishay products not expressly indicated for use in such applications do so at their own risk. Please contact authorized Vishay personnel to obtain written terms and conditions regarding products designed for such applications.

No license, express or implied, by estoppel or otherwise, to any intellectual property rights is granted by this document or by any conduct of Vishay. Product names and markings noted herein may be trademarks of their respective owners.