

# Features

## Regulated Converters

- 2:1 and 4:1 Wide Input Voltage Ranges
- 1kVDC, 2kVD or 3kVDC Isolation
- UL94V-0 Package Material
- Certified for Medical Applications
- Continuous Short Circuit Protection
- Low Noise
- No External Capacitor needed
- Efficiency to 83 %

### Description

High-power-density, an industrial temperature range of -40°C to +85°C and extra features like On-Off-control are just some of the characteristics of this converter, ideal for highly sophisticated industrial-designs. The RSO series is available with isolation of 2kV or 3kV by choosing option "/H2" or "/H3" in which case it is also ideal for medical applications which additionally require EN-60601-1 certification. The standard version offers 2:1 input voltage range, while the "Z" version features 4:1 input voltage range, which includes an input voltage range covering both 5V and 12V supplies.

### Selection Guide

Part Number	Input Voltage Range (VDC)	Rated Output Voltage (VDC)	Output Current (mA)	Efficiency typ. (%)	Max Capacitive Load <sup>(1)</sup>
<b>SIP8</b>					
RSO-xx3.3S*	4.5-9**, 9-18 18-36, 36-72	3.3	300	68-72 70	3300µF
RSO-xx05S*	4.5-9**, 9-18 18-36, 36-72	5	200	73-75 75-78	1200µF
RSO-xx09S*	4.5-9**, 9-18 18-36, 36-72	9	111	74-78 78-81	680µF
RSO-xx12S*	4.5-9**, 9-18 18-36, 36-72	12	83	75-80 80-83	680µF
RSO-xx15S*	4.5-9**, 9-18 18-36, 36-72	15	67	75-80 80-83	680µF
RSO-xx3.3D*	4.5-9**, 9-18 18-36, 36-72	±3.3	±150	68-72 70	±1500µF
RSO-xx05D*	4.5-9**, 9-18 18-36, 36-72	±5	±100	73-75 75-76	±470µF
RSO-xx09D*	4.5-9**, 9-18 18-36, 36-72	±9	±56	74-78 78	±470µF
RSO-xx12D*	4.5-9**, 9-18 18-36, 36-72	±12	±42	75-79 79-80	±330µF
RSO-xx15D*	4.5-9**, 9-18 18-36, 36-72	±15	±34	75-79 79-80	±330µF
RSO-xx3.3SZ*	9-36 18-72	3.3	300	68-70 70	3300µF
RSO-xx05SZ*	4.5-18**, 9-36 18-72	5	200	73-78 75	1200µF
RSO-xx09SZ*	4.5-18**, 9-36 18-72	9	111	75-81 78	680µF
RSO-xx12SZ*	4.5-18**, 9-36 18-72	12	83	77-83 80	680µF
RSO-xx15SZ*	4.5-18**, 9-36 18-72	15	67	78-83 80	680µF
RSO-xx3.3DZ*	9-36 18-72	±3.3	±150	70-74 70	±1500µF
RSO-xx05DZ*	4.5-18**, 9-36 18-72	±5	±100	73-77 75	±470µF
RSO-xx09DZ*	4.5-18**, 9-36 18-72	±9	±56	74-78 78	±470µF
RSO-xx12DZ*	4.5-18**, 9-36 18-72	±12	±42	75-80 80	±330µF
RSO-xx15DZ*	4.5-18**, 9-36 18-72	±15	±34	75-80 80	±330µF

No suffix is standard isolation (1kVDC) e.g, RSO-0505S

\*add suffix /H2 or /H3 for 2kVDC or 3kVDC isolation, e.g, RSO-0505S/H2, RSO-0505DZ/H3

\*\* derate to 75% if Vin<5V, 12V 4:1 input also requires an external 10µF input capacitor.

# ECONOLINE

## DC/DC-Converter

with 3 year Warranty

# RECOM

## 1 Watt SIP8 Isolated Single & Dual Output



# RSO

## Derating-Graph (Ambient Temperature)

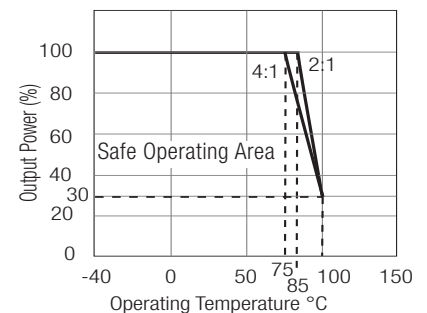

**2:1 Input**  
(RSO-S/D)  
xx = 4.5-9Vin = 05  
xx = 9-18Vin = 12  
xx = 18-36Vin = 24  
xx = 36-72Vin = 48

**4:1 Input**  
(RSO-SZ/DZ)  
xx = 4.5-18Vin = 12  
xx = 9-36Vin = 24  
xx = 18-72Vin = 48

**Specifications** (Core Operating Area) measured at  $T_A = 25^\circ\text{C}$ , nominal input voltage, full load and after warm-up time unless otherwise specified

Input Voltage Range	2:1 and 4:1		
Output Voltage Accuracy	$\pm 2\%$ typ.		
Line Voltage Regulation	2:1	$\pm 0.2\%$ max.	
	4:1	$\pm 0.5\%$ max.	
Load Voltage Regulation (10% to 100% full load)	2:1	$\pm 0.4\%$ max.	
	4:1	$\pm 0.5\%$ typ.	
Minimum Load	10% <sup>(2)</sup>		
Output Ripple and Noise (20MHz limited)	50mVp-p max.		
Operating Frequency	2:1	200kHz min. / 500kHz max.	
	4:1	100kHz min. / 800kHz max.	
Efficiency at Full Load	See Selection Guide		
Quiescent Current	RSO-05xxS_D, SZ_DZ	40mA typ.	
Nominal input Voltage (Standard, /H2 and /H3)	RSO-12xxS_D, SZ_DZ	32mA typ.	
	RSO-24xxS_D, SZ_DZ	25mA typ.	
	RSO-48xxS_D, SZ_DZ	15mA typ.	
CTRL Pin drive current /see Notes)	3mA typ, 6mA max.		
Quiescent Input Current when Converter is OFF	10mA max.		
Isolation Voltage	Standard	(tested for 1 second)	1000VDC
		(rated for 1 minute**)	500VAC / 60Hz
	/H2 Version	(tested for 1 second)	2000VDC
		(rated for 1 minute**)	1000VAC / 60Hz
/H3 Version	(tested for 1 second)	3000VDC	
	(rated for 1 minute**)	1500VAC / 60Hz	
Isolation Capacitance	Standard	2:1 Single	10pF min. / 40pF typ. / 60pF max.
Isolation Capacitance	/H2 and /H3	2:1 Single	5pF min. / 30pF typ. / 60pF max.
Isolation Capacitance	Standard	2:1 Dual	120pF min. / 170pF typ. / 250pF max.
Isolation Capacitance	/H2 and /H3	2:1 Dual	5pF min. / 30pF typ. / 60pF max.
Isolation Capacitance	Standard	4:1 Single/Dual	200pF max.
Isolation Capacitance	/H2 and /H3	4:1 Single/Dual	30pF max.
Isolation Resistance	$> 1\text{G}\Omega$ min.		
Short Circuit Protection	Continuous		
Operating Temperature Range (free air convection)	$-40^\circ\text{C}$ to $+85^\circ\text{C}$ (see Graph)		
Storage Temperature Range	$-55^\circ\text{C}$ to $+125^\circ\text{C}$		
Relative Humidity	95% RH		
Package Weight	4.7g		
Packing Quantity	22 pcs per Tube		
MTBF ( $+25^\circ\text{C}$ )	} <i>Detailed Information see</i> } <i>Application Notes chapter "MTBF"</i>	using MIL-HDBK 217F	$1685 \times 10^3$ hours
		using MIL-HDBK 217F	$254 \times 10^3$ hours
Certifications			
EN General Safety	Report: SPCLVD1605077-10	EN60950-1, AM2:2013	
EN Medical Safety	Report: MDD1205098-3 + RM1205098-3	IEC/EN 60601-1 3rd Edition Medical Report + ISO14971 Risk Assessment	
UL General Safety	Report: E224736-A34	UL60950-1, 2nd Edition 2014 CSA C22.2 60950-1-07, 2nd Edition 2014	

## RSO-24xxS

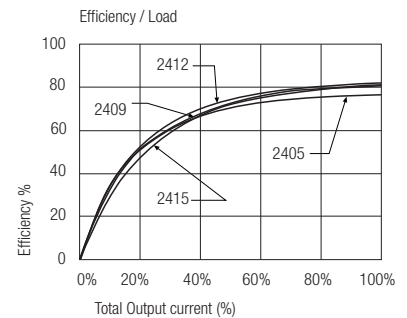

## RSO-1205SZ

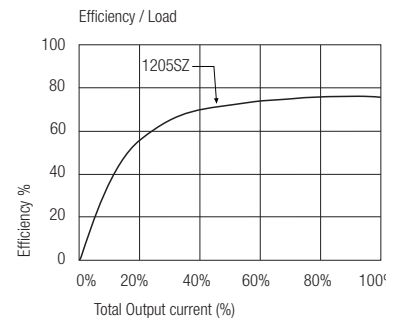

\*\*Any data referred to in this datasheet are of indicative nature and based on our practical experience only. For further details, please refer to our Application Notes.

### Notes

- Note 1: Maximum capacitive load is defined as the capacitive load that will allow start up in under 1 second without damage to the converter
- Note 2: The RSO series requires a minimum of 10% load on the output to maintain specified regulation. Operating under no-load conditions will not damage these devices; however, they may not meet all listed specifications.

**Typical Application**

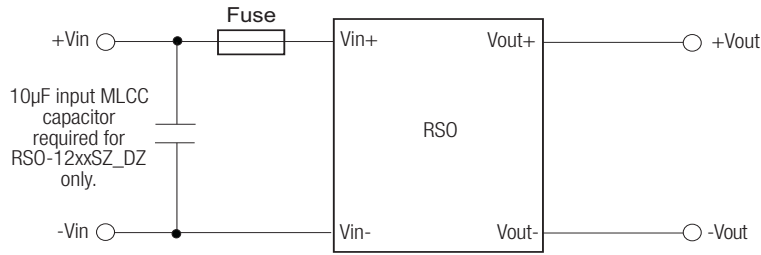

**Package Style and Pinning (mm)**

**8 PIN SIP Package**

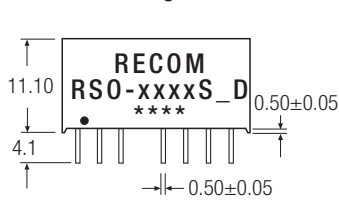

XX.X ± 0.5 mm  
XX.XX ± 0.25 mm

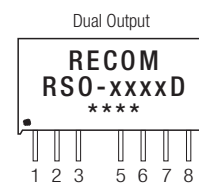
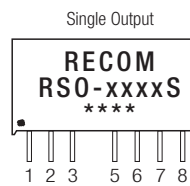

**Recommended Footprint Details**

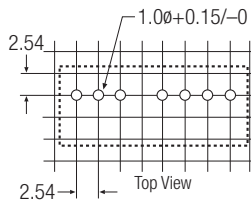
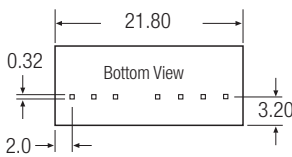

**Pin Connections**

Pin #	Single	Dual
1	-Vin	-Vin
2	+Vin	+Vin
3	CTRL	CTRL
5	NC	NC
6	+Vout	+Vout
7	-Vout	Com
8	NC*	-Vout

NC = No Connection

NC\* = NC, but no external Connection allowed.

**CTRL Examples:**

**Pin 8 (NC\*)** This pin is used internally and must have no external connection.

**Pin 5 (NC)** Not connected internally.

**Pin 3 (CTRL)**

This pin provides an Off function which puts the converter into a low power mode. When the pin is 'high' the converter is OFF and when the pin is high 'Z' the converter is ON. There is no allowed low state for this pin.

**ON/OFF CONTROL**

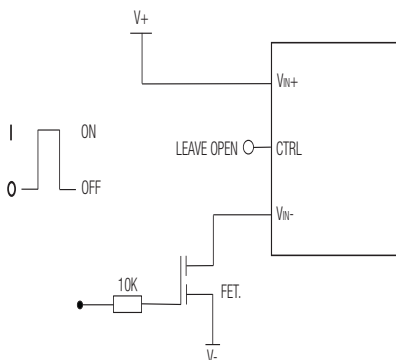

I = 3V  
0 = 0.5V or GND

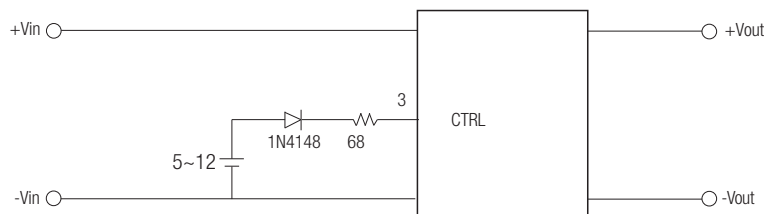

Remote ON/OFF

Ω

ON: open or high impedance

OFF: external 5~12 Vdc and 1N4148+ 68Ω resistor

The product information and specifications are subject to change without prior notice. RECOM products are not authorized for use in safety-critical applications (such as life support) without RECOM's explicit written consent. A safety-critical application is defined as an application where a failure of a RECOM product may reasonably be expected to endanger or cause loss of life, inflict bodily harm or damage property. The buyer shall indemnify and hold harmless RECOM, its affiliated companies and its representatives against any damage claims in connection with the unauthorized use of RECOM products in such safety-critical applications.