

**SERIES: AE40-EW-T | DESCRIPTION: DC-DC CONVERTER**
**FEATURES**

- 40 watts
- -25 to +70°C operating temp
- 4,000 Vdc isolation
- extra wide input voltage 6:1
- input voltage from 200~1,200 Vdc
- OVP protection
- output short circuit protection
- chassis mounted

**MODEL**

MODEL	input voltage range (Vdc)	output voltage (Vdc)	output current		output power max (W)	ripple & noise <sup>1</sup> max (mVp-p)	efficiency <sup>2</sup> typ (%)
			min (A)	max (A)			
AE40-EW-S12-T	200~1200	12	0	3.33	40	200	83
AE40-EW-S15-T	200~1200	15	0	2.67	40	200	84
AE40-EW-S24-T	200~1200	24	0	1.67	40	200	84

Notes: 1. Measured at nominal input, 20 MHz bandwidth oscilloscope, with 10  $\mu$ F electrolytic and 1  $\mu$ F ceramic capacitors on the output.  
 2. Measured at 200 Vdc input voltage, full load.  
 3. All specifications are measured at Ta=25°C, humidity < 75%, nominal input voltage, and rated output load unless otherwise specified.

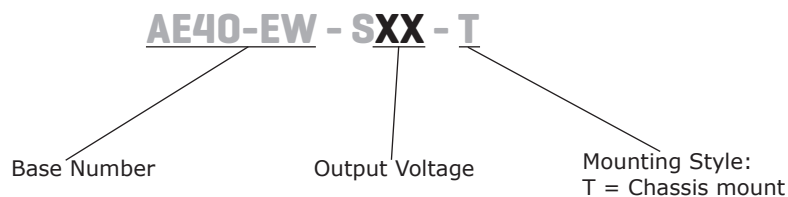
**PART NUMBER KEY**

## INPUT

parameter	conditions/description	min	typ	max	units
operating input voltage		200		1200	Vdc
under voltage shutdown	shut-down range	175		185	Vdc
	turn-on range	185		195	Vdc
current	at 200 Vdc			320	mA
	at 600 Vdc			100	mA
	at 1200 Vdc			55	mA
inrush current	at 600 Vdc		60		A
input fuse	3.5 A / 1500 Vdc (external)				

## OUTPUT

parameter	conditions/description	min	typ	max	units
maximum capacitive load	12 Vdc output model			1,200	μF
	15 Vdc output model			1,000	μF
	24 Vdc output model			680	μF
voltage accuracy			±1	±2	%
line regulation	from low line to high line, full load		±0.5	±1	%
load regulation	from 0% to full load		±0.5	±1	%
delay time	from Vin = 0 V to 90% of rated output voltage			1	s
switching frequency			65		kHz
temperature coefficient	at full load		±0.02		%/°C

## PROTECTIONS

parameter	conditions/description	min	typ	max	units
over voltage protection	12 Vdc, 15 Vdc output models			20	Vdc
	24 Vdc output model			30	Vdc
over current protection	automatic recovery	110			%
short circuit protection	continuous, automatic recovery				

## SAFETY AND COMPLIANCE

parameter	conditions/description	min	typ	max	units
isolation voltage	input to output for 1 minute	4,000			Vdc
conducted emissions	CISPR22/EN55022, class A (external circuit required, see Figure 2)				
radiated emissions	CISPR22/EN55022, class A (external circuit required, see Figure 2)				
ESD	IEC/EN61000-4-2, contact ± 6kV/air ± 8kV, class B				
radiated immunity	IEC/EN61000-4-3, 10V/m, class A				
EFT/burst	IEC/EN61000-4-4, ± 4kV, class B (external circuit required, see Figure 2)				
surge	IEC/EN61000-4-5, ± 2kV, class B (external circuit required, see Figure 2)				
conducted immunity	IEC/EN61000-4-6, 10 Vr.m.s, class A				
magnetic field immunity	IEC/EN61000-4-8, 10 A/m, class A				
voltage dips & interruptions	IEC/EN61000-4-11, 0%-70%, class B				
MTBF	as per MIL-HDBK-217F, 25°C	300,000			hours
RoHS	2011/65/EU				

## ENVIRONMENTAL

parameter	conditions/description	min	typ	max	units
operating temperature	see derating curves	-25		70	°C
storage temperature		-25		85	°C
storage humidity	non-condensing			95	%
altitude				2000	m

## MECHANICAL

parameter	conditions/description	min	typ	max	units
dimensions	135.00 x 70.00 x 33.50 [5.315 x 2.756 x 1.319 inch]				mm
case material	black flame-retardant heat-proof plastic (UL94V-0)				
weight			295		g

## MECHANICAL DRAWING

units: mm [inch]  
tolerance: ±1.00[±0.040]

wire range: 24~12 AWG  
tightening torque: max 0.4 N\*m

PIN CONNECTIONS	
PIN	Function
1	-Vin
2	NC
3	+Vin
4	+Vout
5	NC
6	-Vout
7	NC
8	NC

NC=no connection

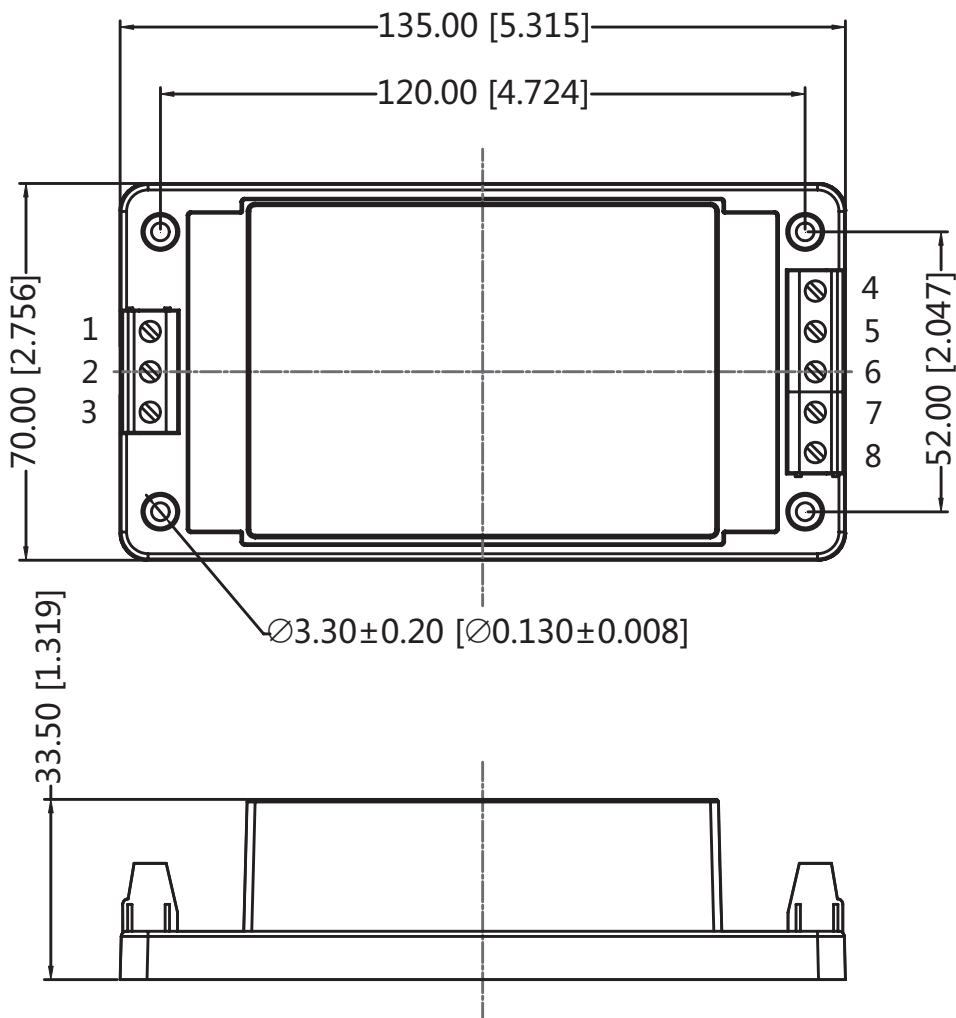

## DERATING CURVES

**TEMPERATURE DERATING CURVE  
(200~1000 Vdc Input voltage)**

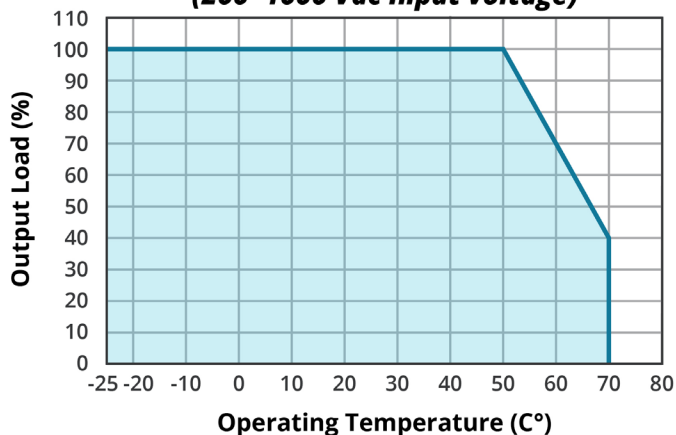

**INPUT VOLTAGE DERATING CURVE  
(at 25°C)**

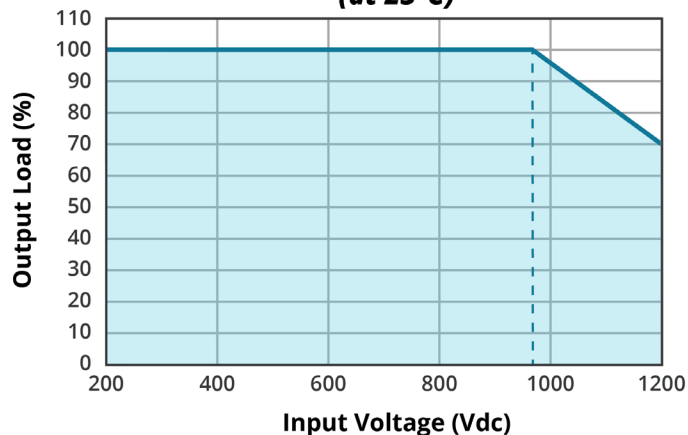

## EFFICIENCY CURVES

**EFFICIENCY VS INPUT VOLTAGE  
AE40-EW-S12-T**

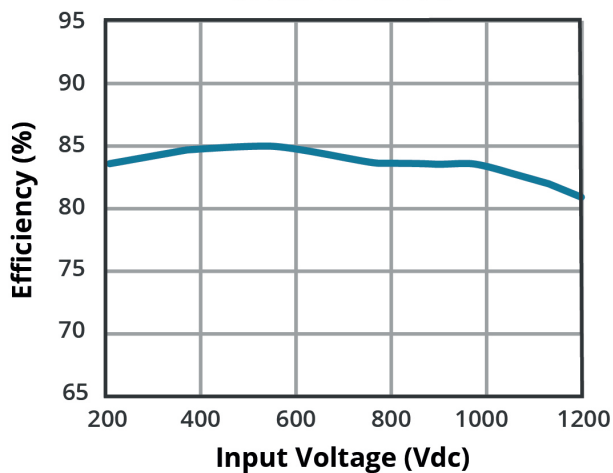

**EFFICIENCY VS OUTPUT LOAD  
AE40-EW-S12-T**

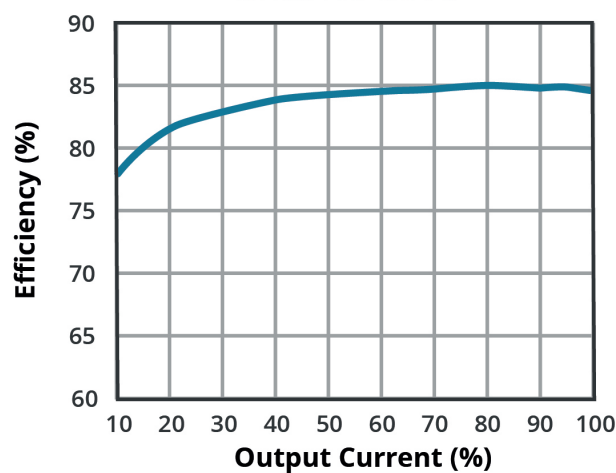

**EFFICIENCY VS INPUT VOLTAGE  
AE40-EW-S15-T**

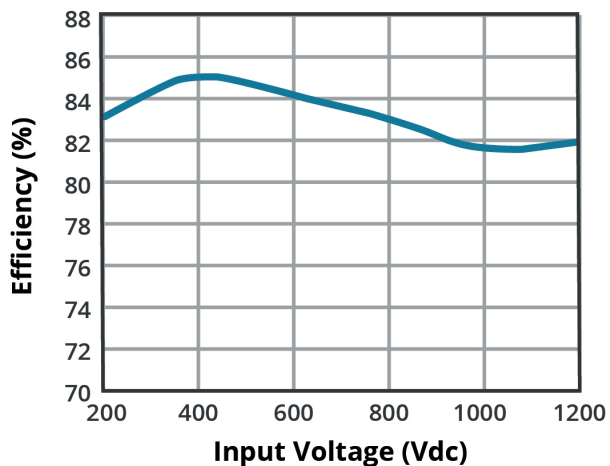

**EFFICIENCY VS OUTPUT LOAD  
AE40-EW-S15-T**

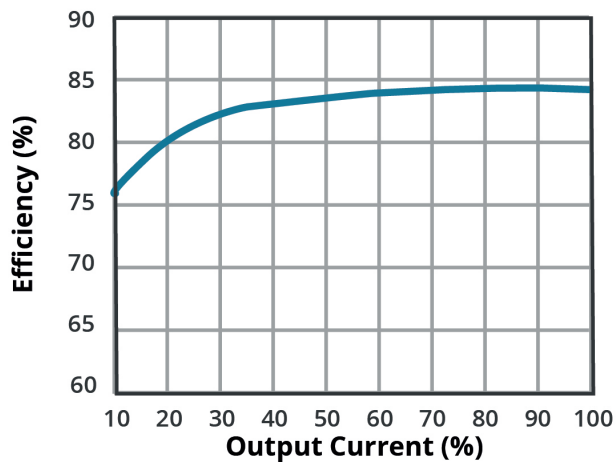

## EFFICIENCY CURVES (CONTINUED)

**EFFICIENCY VS INPUT VOLTAGE  
AE40-EW-S24-T**

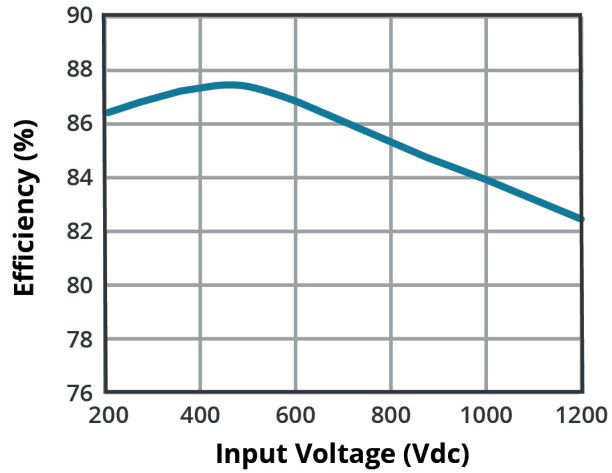

**EFFICIENCY VS OUTPUT LOAD  
AE40-EW-S24-T**

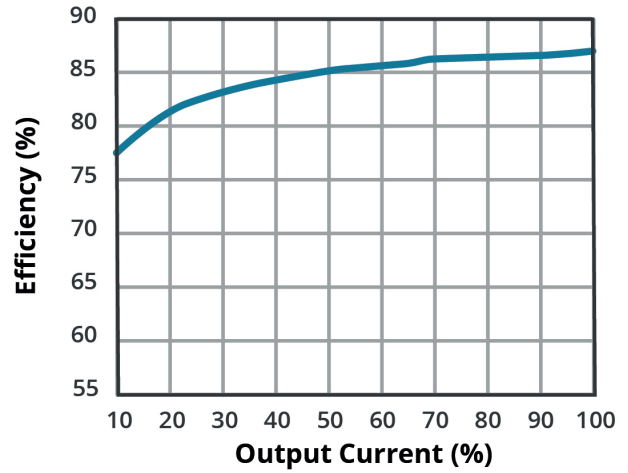

## APPLICATION CIRCUIT

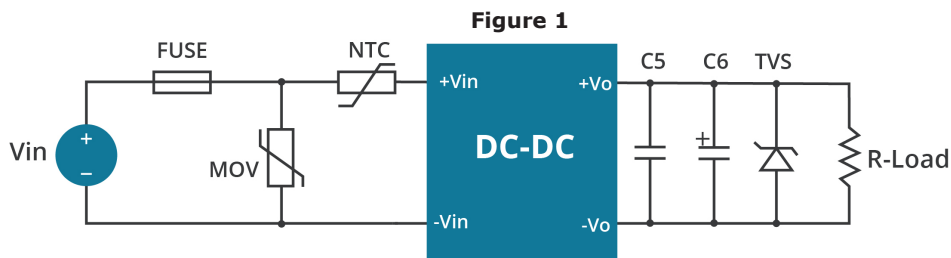

**Table 1**

Vout (Vdc)	Fuse	MOV	NTC	C5 (μF)	C6 (μF)	TVS
12	3.5 A / 1500 Vdc	S20K1000	10D-20	1	220	SMBJ20A
15	3.5 A / 1500 Vdc	S20K1000	10D-20	1	220	SMBJ20A
24	3.5 A / 1500 Vdc	S20K1000	10D-20	1	120	SMBJ30A

## EMC RECOMMENDED CIRCUIT

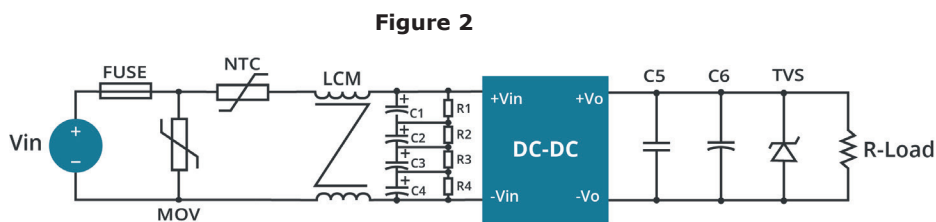

**Table 2**

Recommended External Circuit Components	
FUSE	3.5 A / 1500 Vdc
MOV	S20K1000
NTC	10D-20
LCM	10 mH
C1, C2, C3, C4	47 μF/450 V
R1, R2, R3, R4	1 MΩ/2 W

Note: See also Table 1.

- Notes:
1. C5 is a ceramic capacitor used to filter high frequency noise.
  2. C6 is electrolytic and is recommended to be high frequency and low resistance. For capacitance and current of the capacitor, refer to the datasheet provided by the manufacturer. Capacitance withstand voltage derating should be 80% or above.

## REVISION HISTORY

---

rev.	description	date
1.0	initial release	12/19/2017
1.01	company logo updated	04/12/2021
1.02	derating curves, efficiency curves and circuit figures updated	08/30/2021

The revision history provided is for informational purposes only and is believed to be accurate.



**CUI INC**  
a bel group

**Headquarters**  
20050 SW 112th Ave.  
Tualatin, OR 97062  
**800.275.4899**

Fax 503.612.2383  
**cui.com**  
techsupport@cui.com

CUI offers a two (2) year limited warranty. Complete warranty information is listed on our website.

CUI reserves the right to make changes to the product at any time without notice. Information provided by CUI is believed to be accurate and reliable. However, no responsibility is assumed by CUI for its use, nor for any infringements of patents or other rights of third parties which may result from its use.

CUI products are not authorized or warranted for use as critical components in equipment that requires an extremely high level of reliability. A critical component is any component of a life support device or system whose failure to perform can be reasonably expected to cause the failure of the life support device or system, or to affect its safety or effectiveness.