



M2904

LINEAR INTEGRATED CIRCUIT

SINGLE-SUPPLY DUAL OPERATIONAL AMPLIFIER

DESCRIPTION

The UTC M2904 consists of two independent, high gain, internally frequency compensated operation amplifiers which were designed specifically to operate from a single power supplies is also possible and the low power supply current drain is independent of the magnitude of the power supply voltage.

FEATURES

- *Single Supply
- *Operating Voltage: +3V~+32V
- *Low Operating Current: 0.7mA (typ.)
- *Slew Rate: 0.5V/ μ s (typ.)

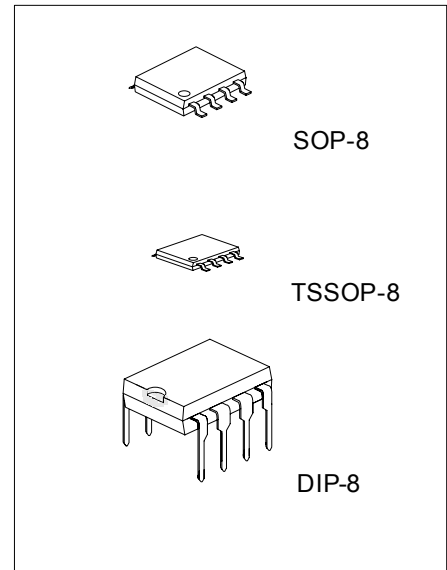

*Pb-free plating product number: M2904L

ORDERING INFORMATION

Order Number		Package	Packing
Normal	Lead Free Plating		
M2904-D08-T	M2904L-D08-T	DIP-8	Tube
M2904-P08-R	M2904L-P08-R	TSSOP-8	Tape Reel
M2904-P08-T	M2904L-P08-T	TSSOP-8	Tube
M2904-S08-R	M2904L-S08-R	SOP-8	Tape Reel
M2904-S08-T	M2904L-S08-T	SOP-8	Tube

<p>M2904L-D08-R</p> <p>(1)Packing Type (2)Package Type (3)Lead Plating</p>	<p>(1) R: Tape Reel, T: Tube (2) D08: DIP-8, P08: TSSOP-8, S08: SOP-8 (3) L: Lead Free Plating Blank: Pb/Sn</p>
--	---

■ PIN CONFIGURATION

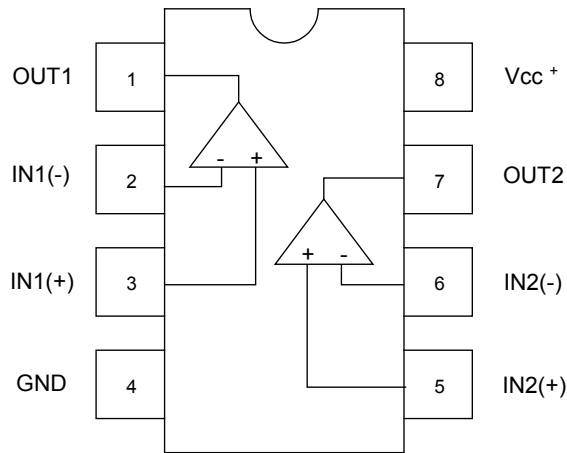

■ EQUIVALENT CIRCUIT (1/2 shown)

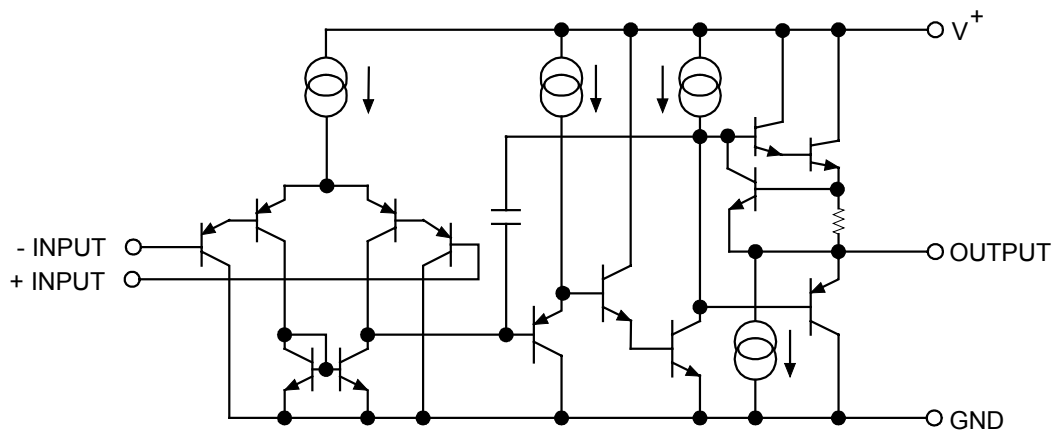

■ ABSOLUTE MAXIMUM RATINGS(Ta=25)

PARAMETER		SYMBOL	RATINGS	UNIT
Supply Voltage		$V^+(V^+/V^-)$	32(or±16)	V
Differential Input Voltage		$V_{I(DIFF)}$	32	V
Input Voltage		V_{IN}	-0.3~+32	V
Power Dissipation	DIP-8	P_D	500	mW
	SOP-8		300	
	TSSOP-8		300	
Junction Temperature		T_J	+125	°C
Operating Temperature		T_{OPR}	-20~+85	°C
Storage Temperature		T_{STG}	-40~+150	°C

Note 1. Absolute maximum ratings are those values beyond which the device could be permanently damaged.

Absolute maximum ratings are stress ratings only and functional device operation is not implied.

2. The device is guaranteed to meet performance specification within 0 ~+70 operating temperature range and assured by design from -20 ~+85 .

■ ELECTRICAL CHARACTERISTICS (Ta=25 , V+=5V)

PARAMETER	SYMBOL	TEST CONDITIONS	MIN	TYP	MAX	UNIT
Input Offset Voltage	$V_{I(OFF)}$	$R_s=0\Omega$		2	7	mV
Input Offset Current	$I_{I(OFF)}$			5	50	nA
Input Bias Current	$I_{I(BIAS)}$			25	250	nA
Large Signal Voltage Gain	GV	$R_L=2k\Omega$		100		dB
Maximum Output Voltage Swing	V_{OM}	$R_L=2k\Omega$	3.5			V
Input Common Mode Voltage	$V_{I(CM)}$		0~3.5			V
Common Mode Rejection Ratio	RR			85		dB
Supply Voltage Rejection Ratio	SVR			100		dB
Output Source Current	I_{SOURCE}	$V_{IN^+}=1V, V_{IN^-}=0V$	20	30		mA
Output Sink Current	I_{SINK}	$V_{IN^+}=0V, V_{IN^-}=1V$	8	20		mA
Channel Separation	CS	f=1k ~20kHz, Input Referred		120		dB
Operating Current	I_{CC}	$R_L=\infty$		0.7	1.2	mA
Slew Rate	SR	$V^+/V^-=\pm 15V$		0.5		V/ μ s
Unity Gain Bandwidth	f_T	$V^+/V^-=\pm 15V$		0.2		MHz

TYPICAL CHARACTERISTICS

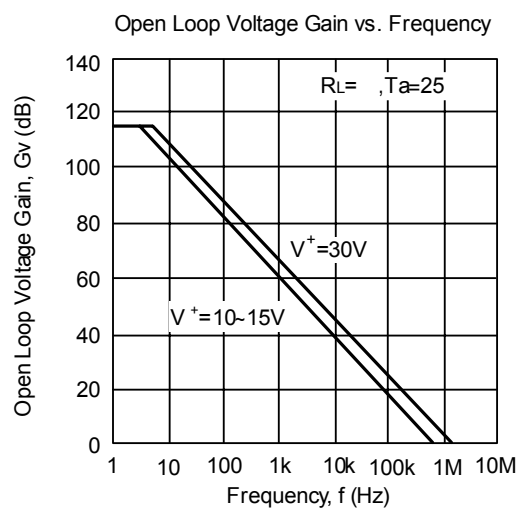
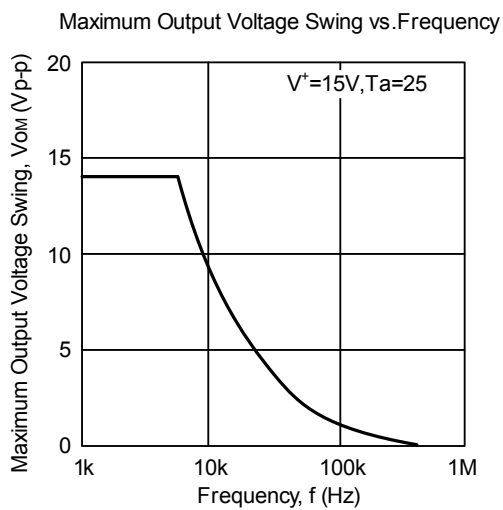
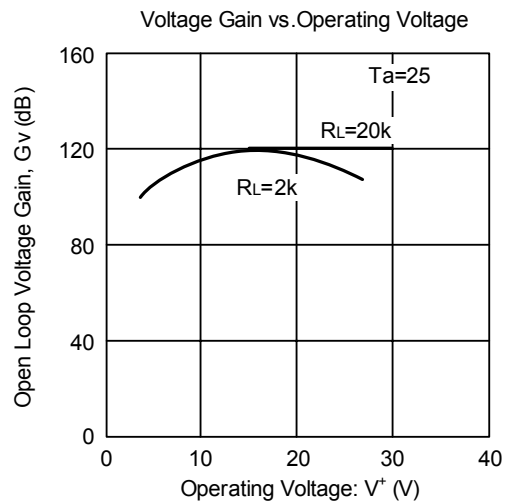
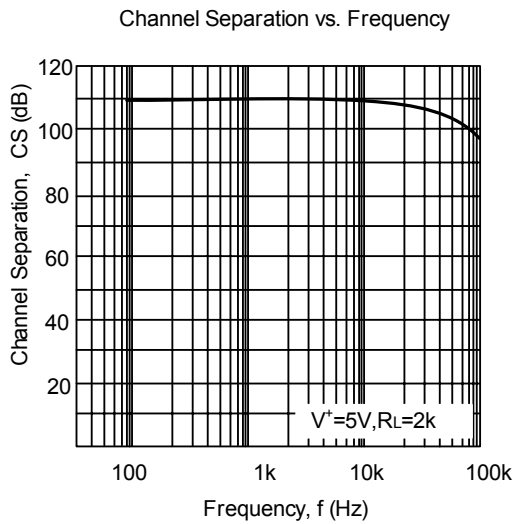
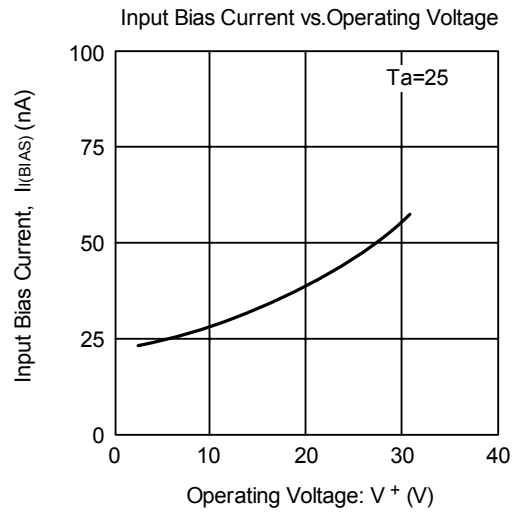
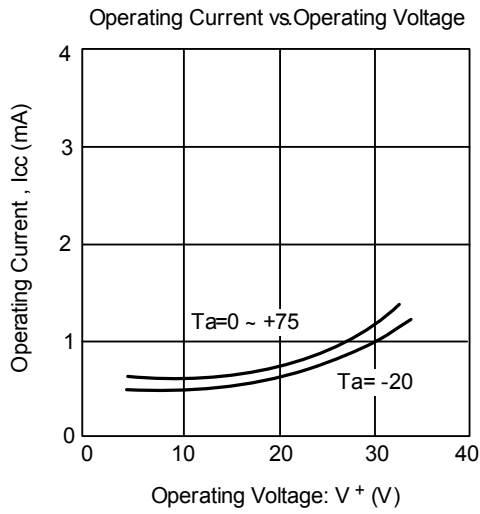

■ TYPICAL CHARACTERISTICS(Cont.)

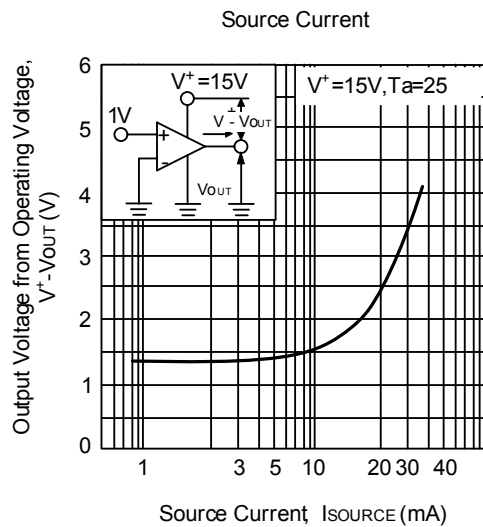
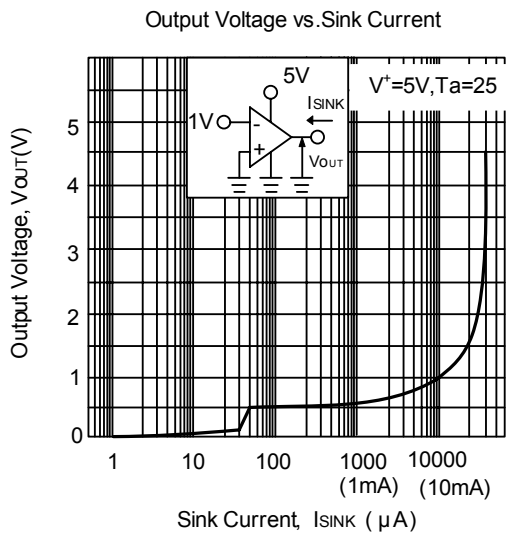
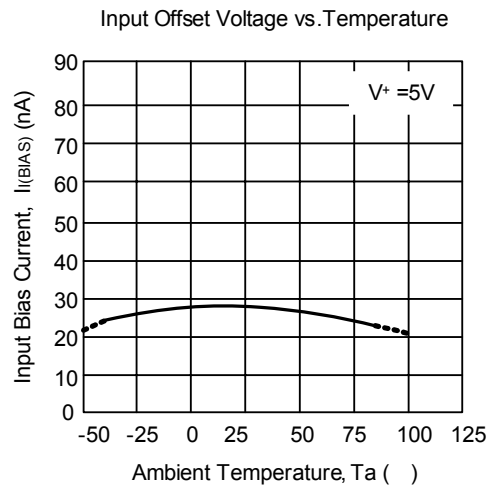
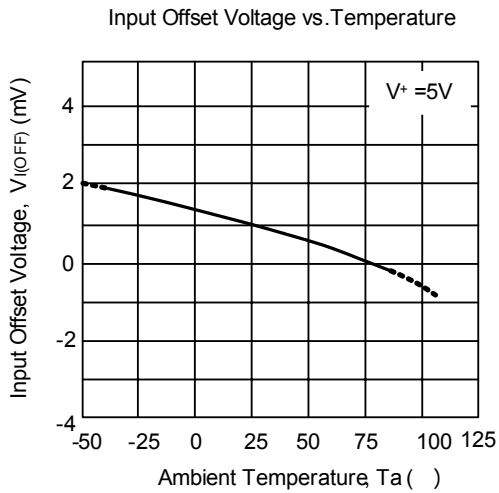
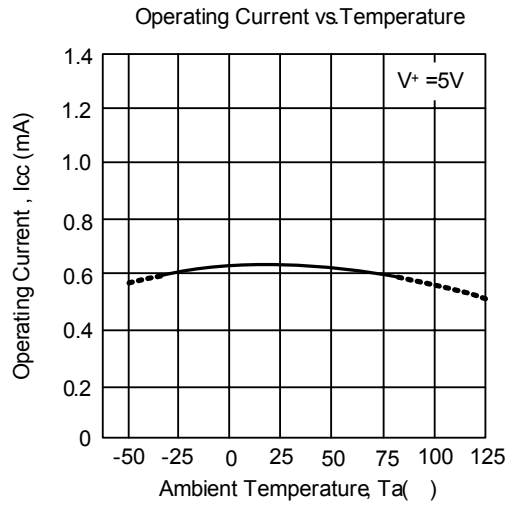
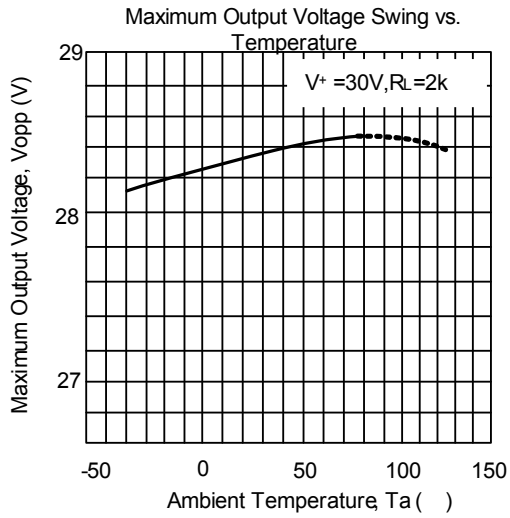

■ TYPICAL CHARACTERISTICS(Cont.)

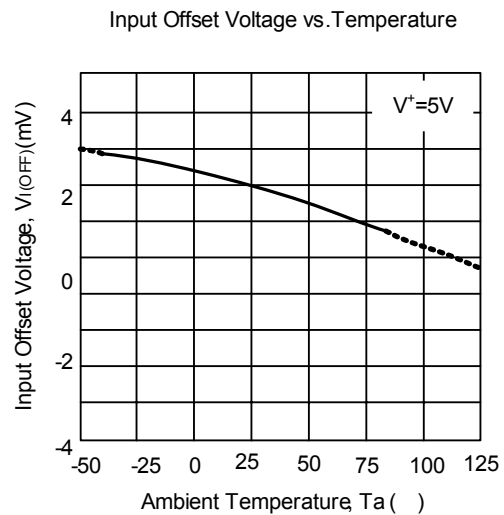
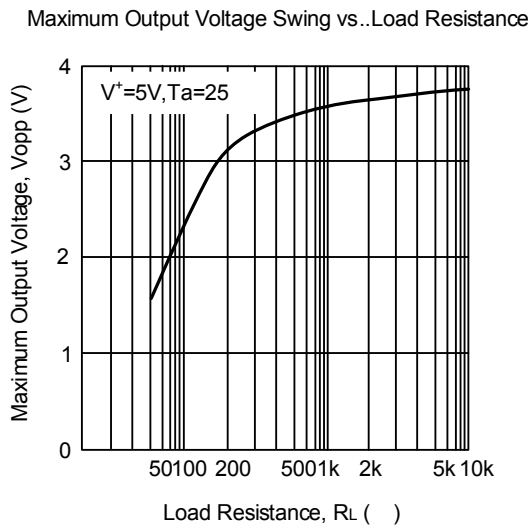
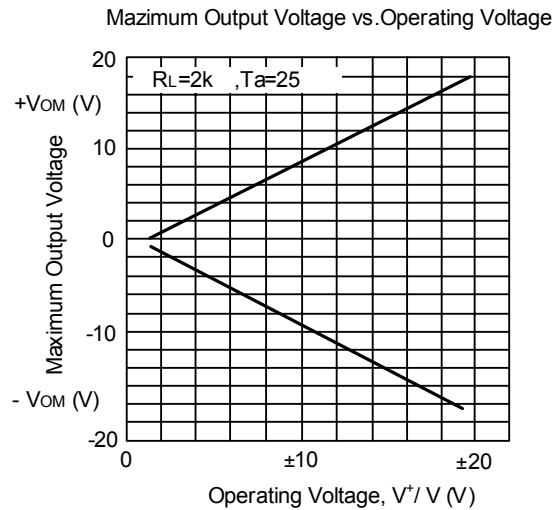
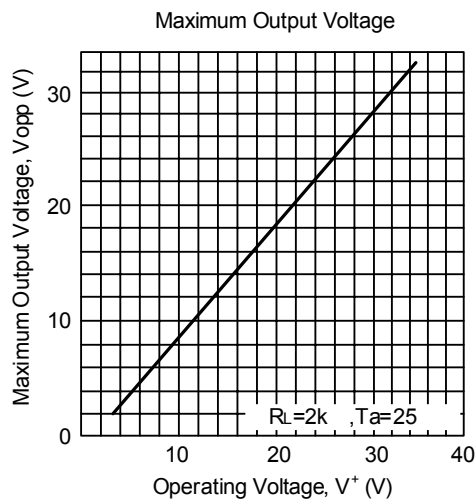

UTC assumes no responsibility for equipment failures that result from using products at values that exceed, even momentarily, rated values (such as maximum ratings, operating condition ranges, or other parameters) listed in products specifications of any and all UTC products described or contained herein. UTC products are not designed for use in life support appliances, devices or systems where malfunction of these products can be reasonably expected to result in personal injury. Reproduction in whole or in part is prohibited without the prior written consent of the copyright owner. The information presented in this document does not form part of any quotation or contract, is believed to be accurate and reliable and may be changed without notice.