

MULTI LAMPS LED BULB

Data Sheet

Description:

These multi lamps LED Bulbs are specifically designed for flashlight electric equipment, indicator light switch and where a wide view angle. The 3mm round shaped radiation pattern (45°) and high luminous intensity ensure that these devices are excellent for wide field of view outdoor applications where a wide viewing angle and readability in sunlight are essential.

High efficiency LED materials are used in this Bulb. Every lamp is made with an advanced optical grade epoxy offering superior high shock and high temperature resistance in outdoor applications.

Feature:

- Wide view angle
- High luminous output
- Seven kind color
- Solid-state Vibration resistant
- Saving power
- Long life

Option:

- 6V to 240V AC or DC
- Other industry standard base

A-BRIGHT

A-BRIGHT INDUSTRIAL CO.,LTD.

Part No.: AB-33B5-12V-E12

Multi Lamps LED Bulb

PACKAGE DIMENSIONS:

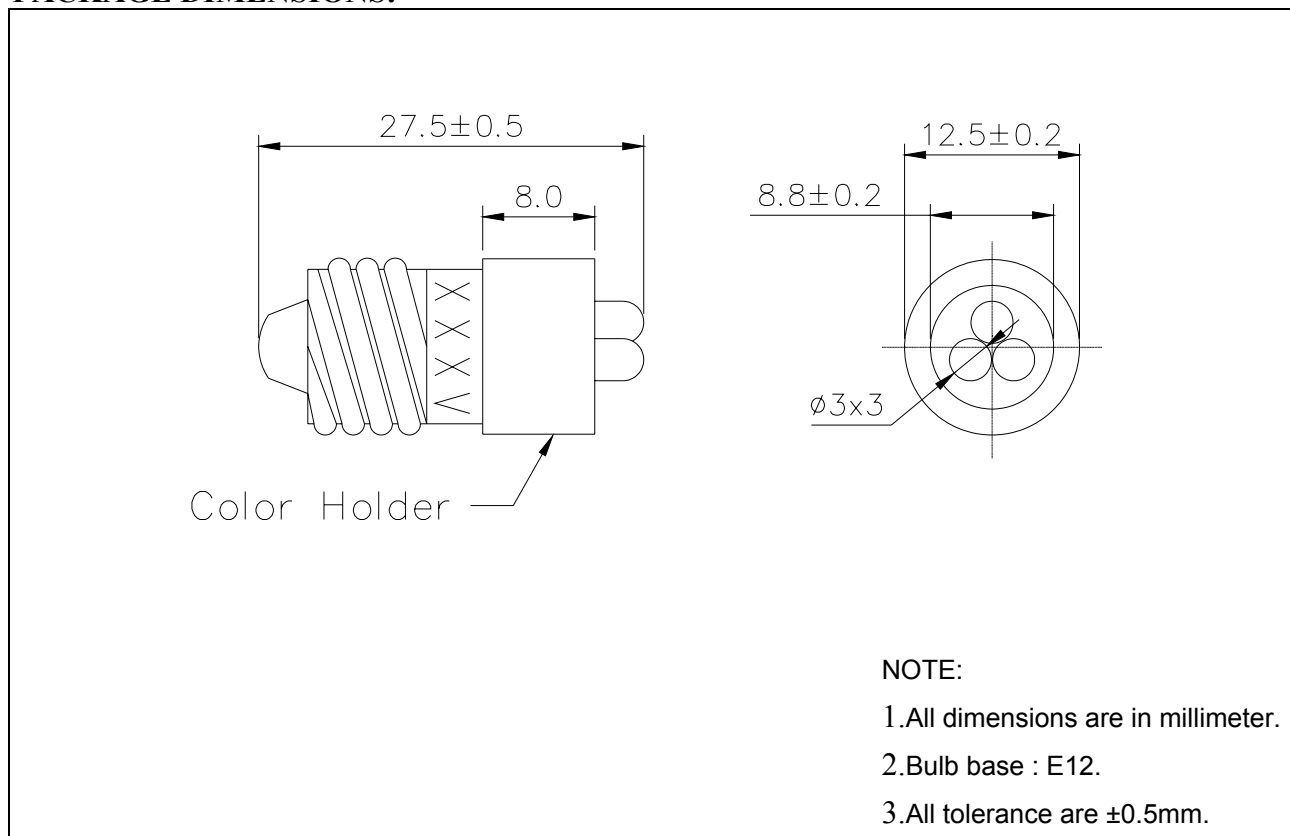

Part No.: AB-33B5-12V-E12

Multi Lamps LED Bulb

FEATURE:

- SUPER LUMINOSITY BLUE LED (InGaN).
- WATER CLEAR PACKAGE.
- 3mm ALL RESIN MOLD.
- WIDE VIEWING ANGLE.
- BASE MODEL E12.
- ELECTRIC AC/DC BI-POLAR.

ABSOLUTE MAXIMUM RATING: Ta = 25 °C

- PEAK OPERATE VOLTAGE..... 14 V
- OPERATING TEMPERATURE..... -25 TO +85°C
- STORAGE TEMPERATURE..... -35 TO +100°C
- LED BULB LIFE..... 20000 HOURS
(LUMINANCE REDUCES to 50%)

ABSOLUTE OPTICAL CHARACTERISTIC Ta= 25°C

PARAMETER		SYMBOL	MIN	TYP	MAX	UNIT
Operate Voltage		V	----	12	14	V
Luminous Intensity	IF= 20 mA	Iv	3000	4500	----	mcd
Dominant Wavelength	IF= 20 mA	λd	----	470	----	nm
Spectrum Radiation Bandwidth	IF= 20 mA	Δλ	----	30	----	nm
Forward Current	VIN=12 V DC	IF	----	20	----	mA
Viewing Angle		2θ1/2	----	45	----	deg