

AQ1003 Series - 30pF 30kV Unidirectional Discrete TVS     



Description

This diode is fabricated in a proprietary silicon avalanche technology that protects each I/O pin at a high level of protection for electronic equipment that may experience destructive electrostatic discharges (ESD). These robust diodes can safely absorb repetitive ESD strikes at $\pm 30\text{kV}$ (contact discharge, IEC 61000-4-2) without performance degradation. Additionally, the diode can safely dissipate 7A of 8/20 μs surge current (IEC 61000-4-5 2nd edition) with very low clamping voltages.

Pinout

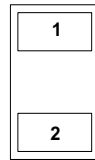

Features

- ESD, IEC 61000-4-2, $\pm 30\text{kV}$ contact, $\pm 30\text{kV}$ air
- EFT, IEC 61000-4-4, 40A (5/50ns)
- Lightning, IEC 61000-4-5 2nd edition, 7A (8/20 μs)
- Low leakage current of 100nA (MAX) at 5V
- Tiny SOD882 (JEDEC MO-236) package saves board space
- Fits solder footprint of industry standard 0402 (1005) components
- AEC-Q101 qualified
- Halogen free, Lead free and RoHS compliant

Functional Block Diagram



Applications

- Mobile phones
- Smart phones
- PDAs
- Portable navigation components
- Digital cameras
- Portable medical components
- Automotive applications

Application Example

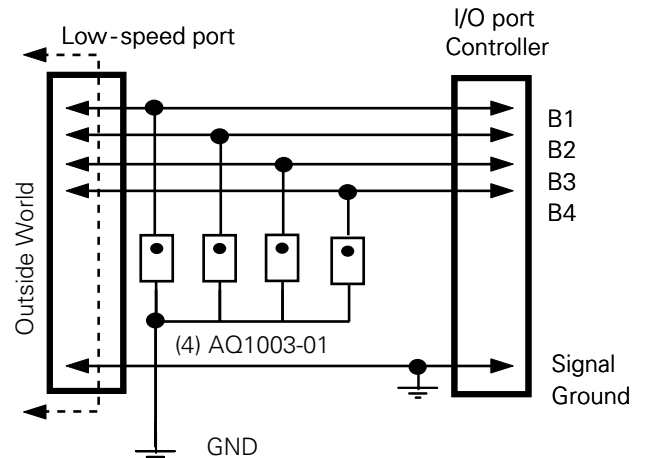

Life Support Note:

Not Intended for Use in Life Support or Life Saving Applications

The products shown herein are not designed for use in life sustaining or life saving applications unless otherwise expressly indicated.

©2017 Littelfuse, Inc.
Specifications are subject to change without notice.
Revision: 11/09/17

Absolute Maximum Ratings

Symbol	Parameter	Value	Units
I_{PP}	Peak Pulse Current ($t_p=8/20\mu s$)	7.0	A
T_{OP}	Operating Temperature	-40 to 150	°C
T_{STOR}	Storage Temperature	-55 to 150	°C

CAUTION: Stresses above those listed in "Absolute Maximum Ratings" may cause permanent damage to the component. This is a stress only rating and operation of the component at these or any other conditions above those indicated in the operational sections of this specification is not implied.

Thermal Information

Parameter	Rating	Units
Maximum Junction Temperature	150	°C
Maximum Lead Temperature (Soldering 20-40s)	260	°C

Electrical Characteristics ($T_{OP}=25^\circ C$)

Parameter	Symbol	Test Conditions	Min	Typ	Max	Units
Forward Voltage Drop	V_F	$I_F = 10mA$		0.8	1.2	V
Reverse Voltage Drop	V_R	$I_R = 1mA$	6.0	7.8	8.5	V
Reverse Standoff Voltage	V_{RWM}	$I_R \leq 1\mu A$			5.0	V
Reverse Leakage Current	I_{LEAK}	$V_R = 5V$			100	nA
Clamp Voltage ¹	V_C	$I_{PP} = 6A$ $t_p = 8/20\mu s$		11.4		V
		$I_{PP} = 7A$ $t_p = 8/20\mu s$		12.0		V
Dynamic Resistance ²	R_{DYN}	TLP, $t_p = 100ns$, I/O to GND		0.25		Ω
ESD Withstand Voltage ¹	V_{ESD}	IEC 61000-4-2 (Contact Discharge)		± 30		kV
		IEC 61000-4-2 (Air Discharge)		± 30		kV
Diode Capacitance ¹	C_D	Reverse Bias=0V		30		pF

Note: 1 Parameter is guaranteed by design and/or component characterization.

2 Transmission Line Pulse (TLP) with 100ns width, 2ns rise time, and average window $t_1=70ns$ to $t_2=90ns$

Capacitance vs. Reverse Bias

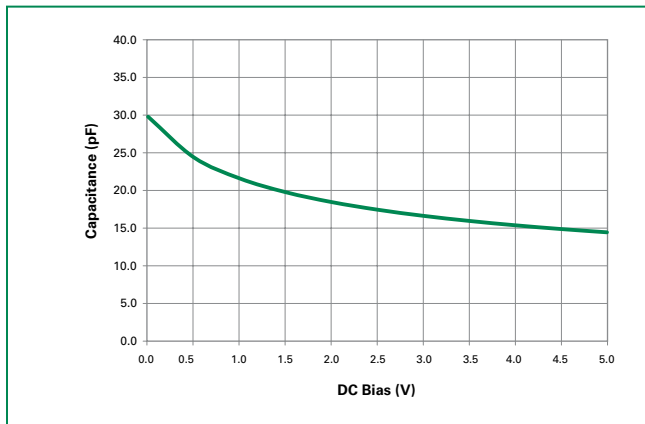

Clamping Voltage vs. I_{PP}

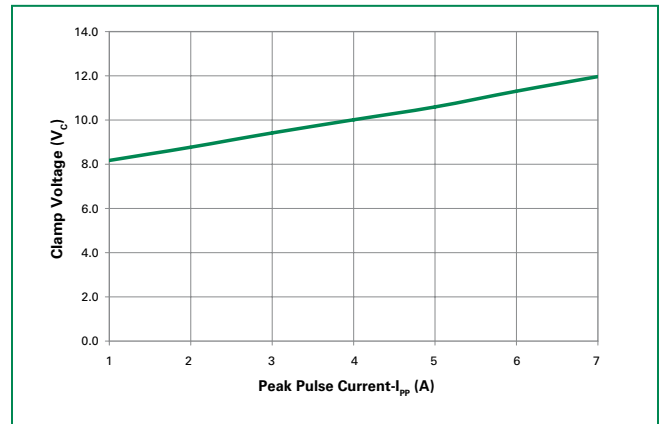

Transmission Line Pulsing (TLP) Plot

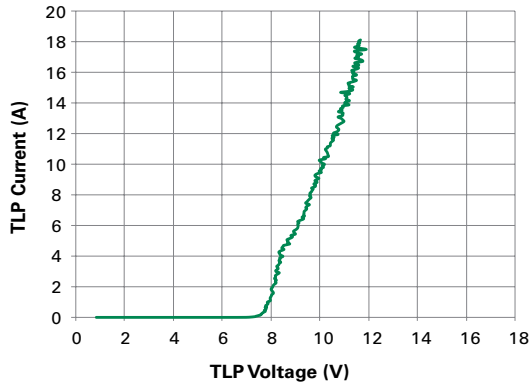

Leakage vs. Temperature

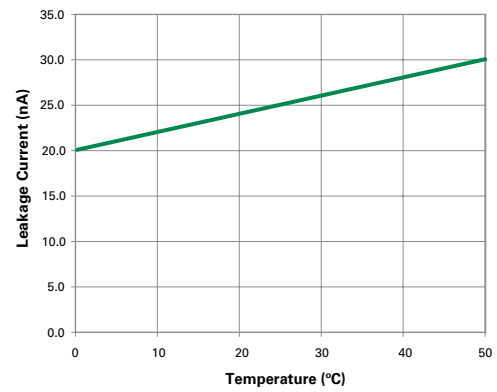

8/20µs Pulse Waveform

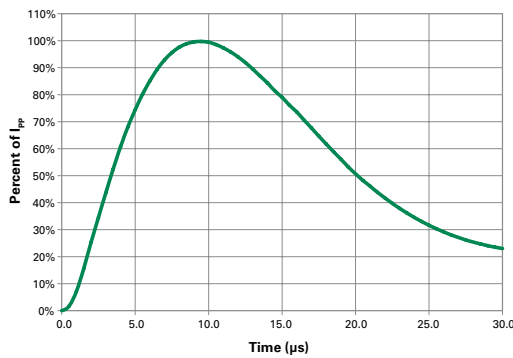

Soldering Parameters

Reflow Condition		Pb – Free assembly
Pre Heat	- Temperature Min ($T_{s(min)}$)	150°C
	- Temperature Max ($T_{s(max)}$)	200°C
	- Time (min to max) (t_s)	60 – 180 secs
Average ramp up rate (Liquidus) Temp (T_L) to peak		3°C/second max
$T_{s(max)}$ to T_L - Ramp-up Rate		3°C/second max
Reflow	- Temperature (T_L) (Liquidus)	217°C
	- Temperature (t_L)	60 – 150 seconds
Peak Temperature (T_p)		260 ^{+0/-5} °C
Time within 5°C of actual peak Temperature (t_p)		20 – 40 seconds
Ramp-down Rate		6°C/second max
Time 25°C to peak Temperature (T_p)		8 minutes Max.
Do not exceed		260°C

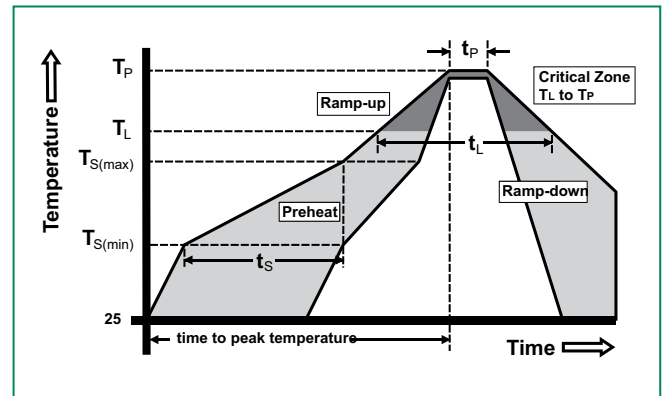

Part Numbering System

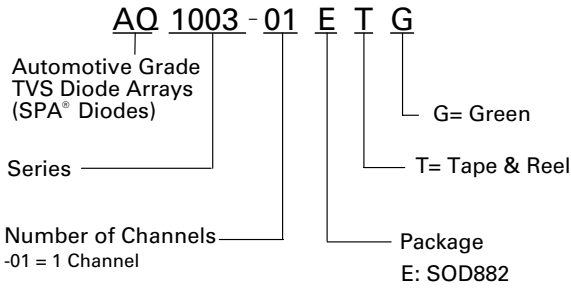

Part Marking System

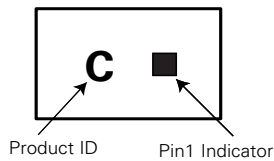

Product Characteristics

Lead Plating	Pre-Plated Frame
Lead Material	Copper Alloy
Substrate material	Silicon
Body Material	Molded Epoxy
Flammability	UL Recognized epoxy meeting flammability rating V-0.

- Notes :
1. All dimensions are in millimeters
 2. Dimensions include solder plating.
 3. Dimensions are exclusive of mold flash & metal burr.
 4. Blo is facing up for mold and facing down for trim/form, i.e. reverse trim/form.
 5. Package surface matte finish VDI 11-13.

Ordering Information

Part Number	Package	Marking	Min. Order Qty.
AQ1003-01ETG	SOD882	C	10000

Package Dimensions – SOD882

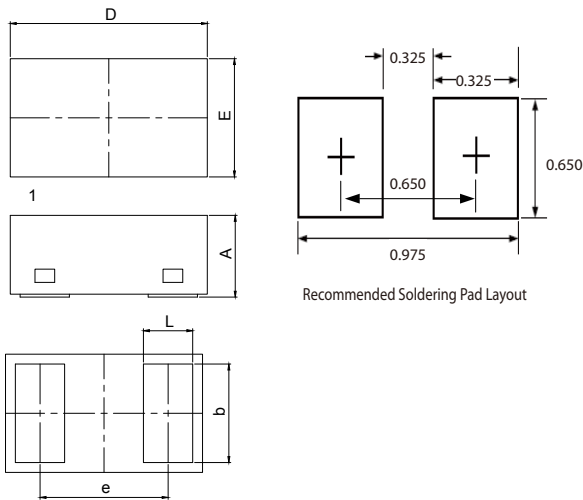

Symbol	Package	SOD882			
	JEDEC	MO-236			
		Millimeters		Inches	
		Min	Max	Min	Max
A		0.36	0.42	0.014	0.017
b		0.45	0.55	0.018	0.022
L		0.20	0.30	0.008	0.012
e		0.65		0.026	
D		0.93	1.07	0.037	0.042
E		0.53	0.67	0.021	0.026

Embossed Carrier Tape & Reel Specification – SOD882

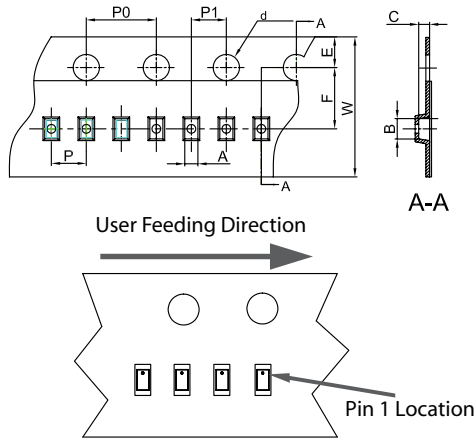

Symbol	Millimetres		Inches	
	Min	Max	Min	Max
A	0.65	0.70	0.026	0.028
B	1.10	1.20	0.043	0.047
C	0.50	0.60	0.020	0.024
d	1.40	1.60	0.055	0.063
E	1.65	1.85	0.065	0.073
F	3.40	3.60	0.134	0.142
P0	3.90	4.10	0.154	0.161
P	1.90	2.10	0.075	0.083
P1	1.90	2.10	0.075	0.083
W	7.90	8.10	0.311	0.319

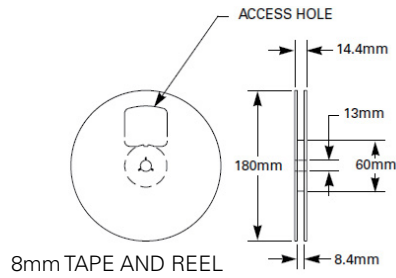

Disclaimer Notice - Information furnished is believed to be accurate and reliable. However, users should independently evaluate the suitability of and test each product selected for their own applications. Littelfuse products are not designed for, and may not be used in, all applications. Read complete Disclaimer Notice at <http://www.littelfuse.com/disclaimer-electronics>.