

SMD Power Inductor

252010CDMCC/DS



Description

- Metal compound molding type construction
- Magnetically shielded
- Low audible core noise
- Suitable for large current.
- LxWxH:2.7x2.2x1.0mm Max.
- Product weight: 0.34mg (Ref.)
- Moisture Sensitivity Level: 1



Environmental Data

- Operating temperature range: -55°C~+125°C (including coil's self temperature rise)
- Storage temperature range: -55°C~+125°C

Packaging

- Carrier tape and reel packaging. 3,000pcs per reel.

Applications

- DC/DC converter for CPU in Notebook PC. Smartphones, LCD displays, HDDs, DVDs, DVCs, DSCs, PDAs ect..
- Thin type on-board power supply module for exchanger VRM for server.
- Low profile, high current power supplies. Battery powered devices.

Dimension - [mm]

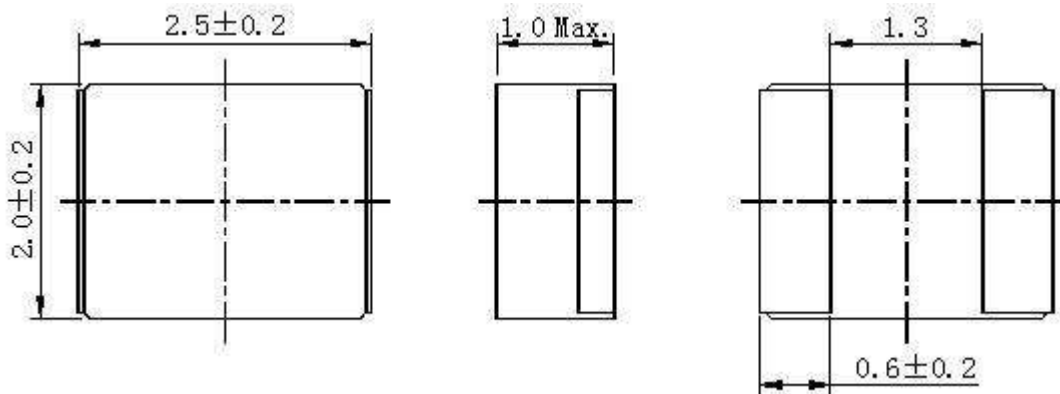

Recommended Land pattern - [mm]

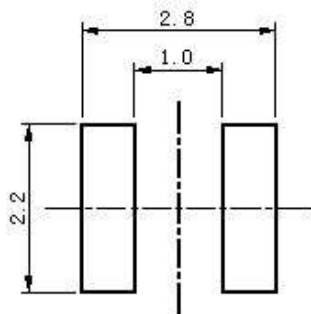

Wire Connection

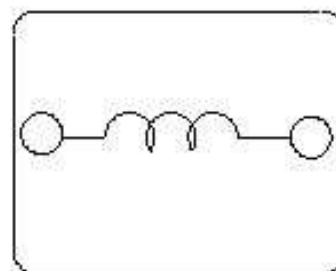

Note: This specification is subject to change without notice. Please contact your nearest sales office for updated information when placing an order.

SMD Power Inductor

252010CDMCC/DS



Electrical Characteristics

Part Number	Inductance [Within] (μ H) ※1	D.C.R. at 20°C max(typ) (m Ω)	Saturation Current at 20°C(A) ※2	Temperature Rise Current (A) ※3
252010CDMCCDS-R33MC	0.33 \pm 20%	19.00 (16.00)	6.80	5.20
252010CDMCCDS-R47MC	0.47 \pm 20%	25.00 (21.00)	5.70	4.80
252010CDMCCDS-1R0MC	1.00 \pm 20%	55.00 (46.00)	3.80	3.20
252010CDMCCDS-2R2MC	2.20 \pm 20%	113 (94.00)	2.60	2.10

※ 1. Measuring frequency Inductance at 1MHz, 0. 1V.

※ 2. Saturation current: The actual value of D.C current when the inductance decreases to 70% of it's initial value.

※ 3. Temperature rise current: The actual value of DC current when the coil temperature rise is $\Delta T=40^{\circ}\text{C}$

(Ta=25°C) Board conditions: FR4, Copper=70 μ m, four-layer PWB, t=1.6mm.

Solder Reflow Condition

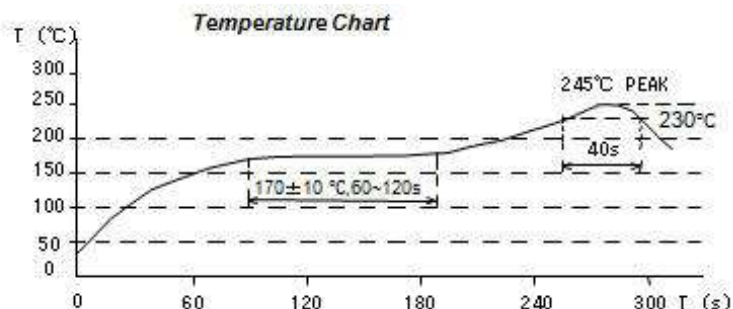
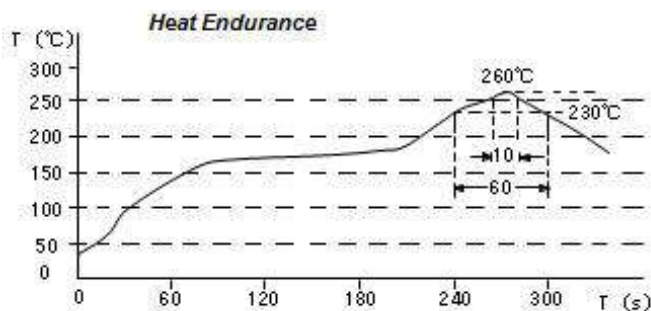

SMD Power Inductor

252010CDMCC/DS



Saturation Current & Temperature Rise Graph

— L (20°C) — ΔT

1. 252010CDMCCDS-R33MC

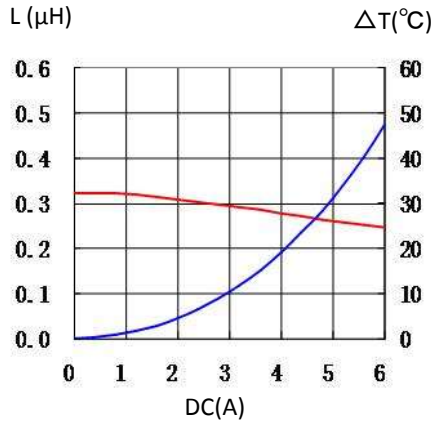

2. 252010CDMCCDS-R47MC

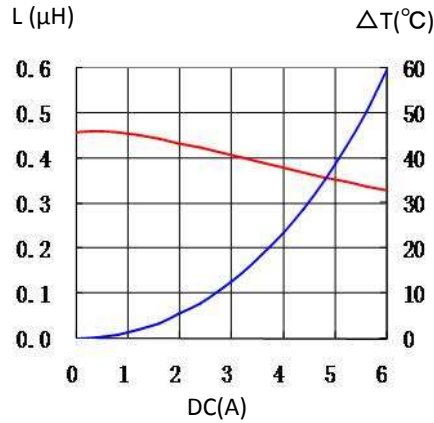

3. 252010CDMCCDS-1R0MC

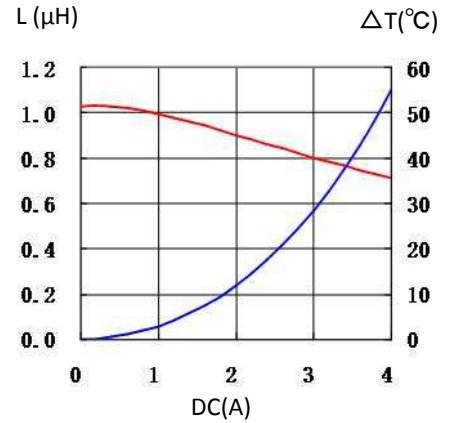

4. 252010CDMCCDS-2R2MC

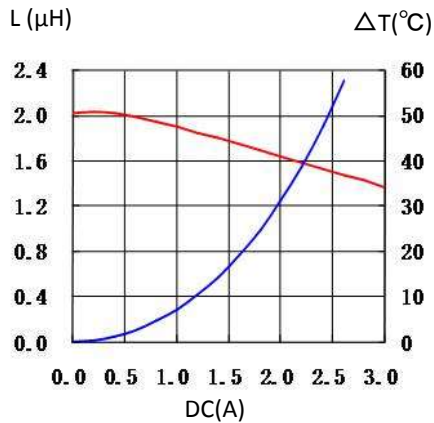

For sales office information, please [click here](#) to visit our website.